

Job Name/Location:

Tag No:

Date:

For:	File	Resubmit
	Approval	Other

PO No.:

Architect: GC:

Engr: Mech:

Rep: (Company) (Project Manager)



LMU303HV

Multi F Inverter Heat Pump Outdoor Unit

Performance:

Cooling Capacity (Min.-Rated-Max., Btu/h)	8,400-30,000-36,000
Heating Capacity (Min.-Rated-Max., Btu/h)	10,080-32,000-38,400
Max. Heating Capacity at 5°F (Btu/h)	24,000
Max. Heating Capacity at 0°F (Btu/h)	22,000
Max. Heating Capacity at -4°F (Btu/h)	20,400
EER2	13.0
SEER2	22.0
COP	4.0
HSPF2	9.2

Cooling Nominal Test Conditions:
Indoor: 80°F DB / 67°F WB
Outdoor: 95°F DB / 75°F WB

Heating Nominal Test Conditions:
Indoor: 70°F DB / 60°F WB
Outdoor: 47°F DB / 43°F WB

Operating Range:

Cooling (°F DB)	14 to 118
Heating (°F WB)	-4 to +64

Unit Data:

Refrigerant Type	R410A
Refrigerant Control	EEV
Sound Pressure (Cool / Heat) ±1 dB(A) ³	51 / 54
Net / Shipping Weight (lbs.)	138.9 / 154.3
Heat Exchanger Coating	Gold Fin™
Minimum No. of Indoor Units	2
Maximum No. of Indoor Units	4

Electrical:

Power Supply (V/Hz/Ø) ¹	208-230V, 60, 1
MOP (A)	25
MCA (A)	18.4
Recommended Fuse Size (A)	25
Cooling Rated Amps (A)	15.03
Heating Rated Amps (A)	15.03
Compressor (A)	13.5
Fan Motor (A)	0.73
Locked Rotor Amps (A)	19.0

MOP - Maximum Overcurrent Protection

MCA - Minimum Circuit Ampacity

Compressor:

Type	Twin Rotary
Quantity	1
Oil / Type	FVC68D

Fan:

Type	Propeller
Quantity	1
Motor / Drive	Brushless Digitally Controlled/Direct
Max. Airflow Rate (CFM)	2,119

Piping:

Refrigerant Charge (lbs.)	6.17
Liquid Line Connection (in., O.D.)	1/4 x 4
Vapor Line Connection (in., O.D.)	3/8 x 4
Maximum Total Piping ² (ft.)	246.1
Min. / Max. ODU to IDU Piping (ft.)	9.8 / 82.0
Piping Length (no add'l refrigerant, ft.)	98.4
Maximum Elevation between ODU and IDU (ft.)	49.2
Maximum Elevation between IDU and IDU (ft.)	24.6

ODU = Outdoor Unit

IDU = Indoor Unit

Features:

- Auto operation
- Auto restart
- Inverter (variable speed compressor)
- Defrost / Deicing
- Restart delay (three [3] minutes)
- Self diagnosis
- Soft start
- Low ambient cooling down to 14°F

Optional Accessories:

- PI-485 - PMNFP14A1
- MultiSITE Comm. Mgr. - PBACNBTR0A
- AC Smart 5 - PACS5A000
- ACP 5 - PACP5A000
- Power Distribution Indicator (PDI) Premium - PQNUD1S41
- Mobile LGMV - PLGMVW100
- Drain Pan Heater - PQSH1200
- Low Ambient Baffle Kit (Cooling operation to -4°F) - ZLABGP04A



162279



For a complete list of available accessories, contact your LG representative.

For continual product development, LG reserves the right to change specifications without notice.

© LG Electronics U.S.A., Inc., Englewood Cliffs, NJ. All rights reserved. "LG Life's Good" is a registered trademark of LG Corp. /www.lghvac.com

SB_MultiF_LMU303HV_2022_07_18_084716

Job Name/Location: _____

LMU303HV

Multi F Inverter Heat Pump Outdoor Unit



Tag No.: _____

Date: _____

PO No.: _____



[Unit : mm(inch)]

☉ Gravity point

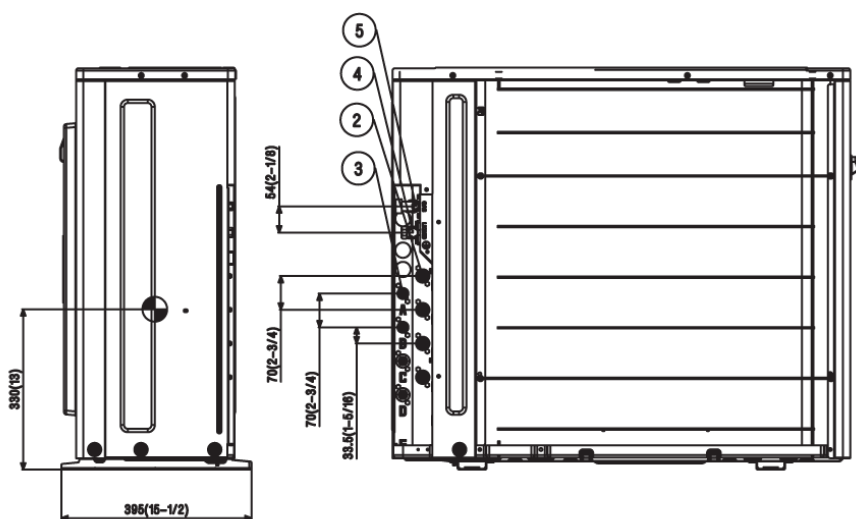
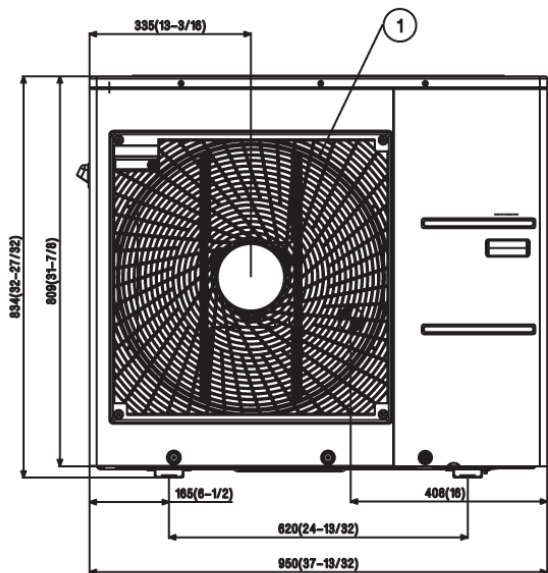

Notes:

1. Unit must be installed in compliance with the installation manual.
2. Unit must be grounded in accordance with the local or state regulations and applicable national codes.
3. All field-supplied electrical components and materials must comply with local, state, and national codes.
4. Electrical characteristics must be considered for electrical work and design. The capacity of power cable and circuit breaker for the outdoor unit must follow local, state, national, and manufacturer requirements.

No.	Part Name
1	Air discharge grille
2	Vapor pipe connection
3	Liquid pipe connection
4	Main service valve (Liquid)
5	Main service valve (Vapor)

Date: _____ For: File Resubmit
 PO No.: _____ Approval Other _____
 Architect: _____ GC: _____
 Engr: _____ Mech: _____
 Rep: _____
 (Company) _____ (Project Manager) _____



LMAN097HVP
 Multi F Art Cool™ Gallery
 9,000 Btu/h Indoor Unit



Performance:

Nominal Cooling Capacity (Btu/h)	9,000
Nominal Heating Capacity (Btu/h)	10,400

Cooling Nominal Test Conditions: Indoor: 80°F DB/67°F WB Outdoor: 95°F DB/75°F WB
 Heating Nominal Test Conditions: Indoor: 70°F DB/60°F WB Outdoor: 47°F DB/43°F WB

Electrical:

Power Supply (V ¹ /Hz/Ø)	208-230/60/1
Rated Amps (A)	0.2

Piping:

Liquid Line (in, OD)	1/4
Vapor Line (in, OD)	3/8
Drain OD, ID (in)	13/16, 5/8
Temperature Sensor	Thermistor

Features:

- 24-Hour on/off timer
- Auto operation
- Auto restart
- Chaos Swing
- Inverter (variable speed fan)
- Jet Cool/Jet Heat
- Self-cleaning indoor coil
- Condensate sensor connection
- Group control

Included Accessories:

- Wireless Handheld Remote Controller - AKB73635607

Optional Accessories:

- LG Programmable Thermostat - PREMTB10U
- Simple Controller with Mode (Black) - PQRVCVCL0Q
- Simple Controller with Mode (White) - PQRVCVCL0QW
- Simple Controller without Mode (Black) - PQRCHCA0Q
- Simple Controller without Mode (White) - PQRCHCA0QW
- AC Smart Premium - PQCSW421E0A
- ACP Premium - PQPC22A1
- ACP Standard - PQPC22N1
- LonWorks Gateway - PQNFB16A1
- BACnet Gateway - PQNFB17B0
- AC Ez - PQCSZ250S0
- Dry Contact Unit (1 contact, 24 VAC external power) - PQDSB1
- Dry Contact Unit (2 input, power from indoor unit) - PQDSBC
- Dry Contact for third party thermostat - PQDSBNGCM1

Operating Range:

Cooling (°F WB)	57-77
Heating (°F DB)	59-81

Unit Data:

Refrigerant Type	R410A
Refrigerant Control	EEV
Sound Pressure ² H/M/L (±3 dB(A))	39/35/31
Primary Filter	Washable Pre-filter
Net Unit Weight (lbs)	32
Shipping Weight (lbs)	37

Fan:

Type	Turbo
Quantity	1
Motor/Drive	Brushless Digitally Controlled/Direct
Airflow Rate H/M/L (CFM)	272/208/155

Notes:

1. Acceptable operating voltage: 187V - 253V.
2. Sound Pressure levels are tested in an anechoic chamber under ISO Standard 1996.
3. See Engineering Manual for sensible and latent capacities.
4. All power/communication cable to be minimum 18 AWG, 4-conductor, stranded, shielded and must comply with applicable local and national code.
5. Power wiring cable size must comply with the applicable local and national code.
6. This unit comes with a dry helium charge.
7. Corresponding refrigerant piping length is in accordance with standard length of each outdoor unit and the level difference is 0 ft. All capacities are net with a combination ratio between 95 - 105%
8. Must follow installation instructions in the applicable LG installation manual.



LMAN097HVP
 Multi F Art Cool™ Gallery
 9,000 Btu/h Indoor Unit



Tag #: _____
 Date: _____
 PO No.: _____

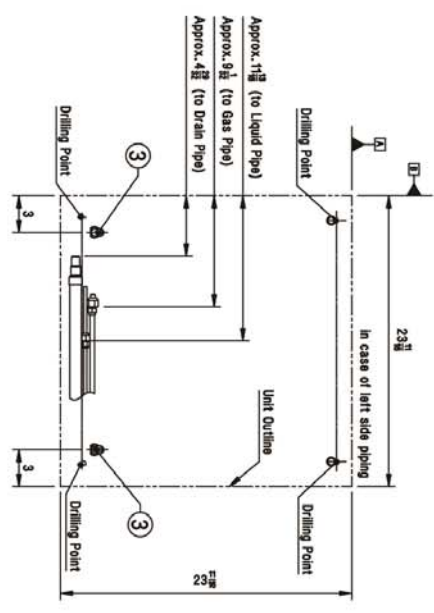
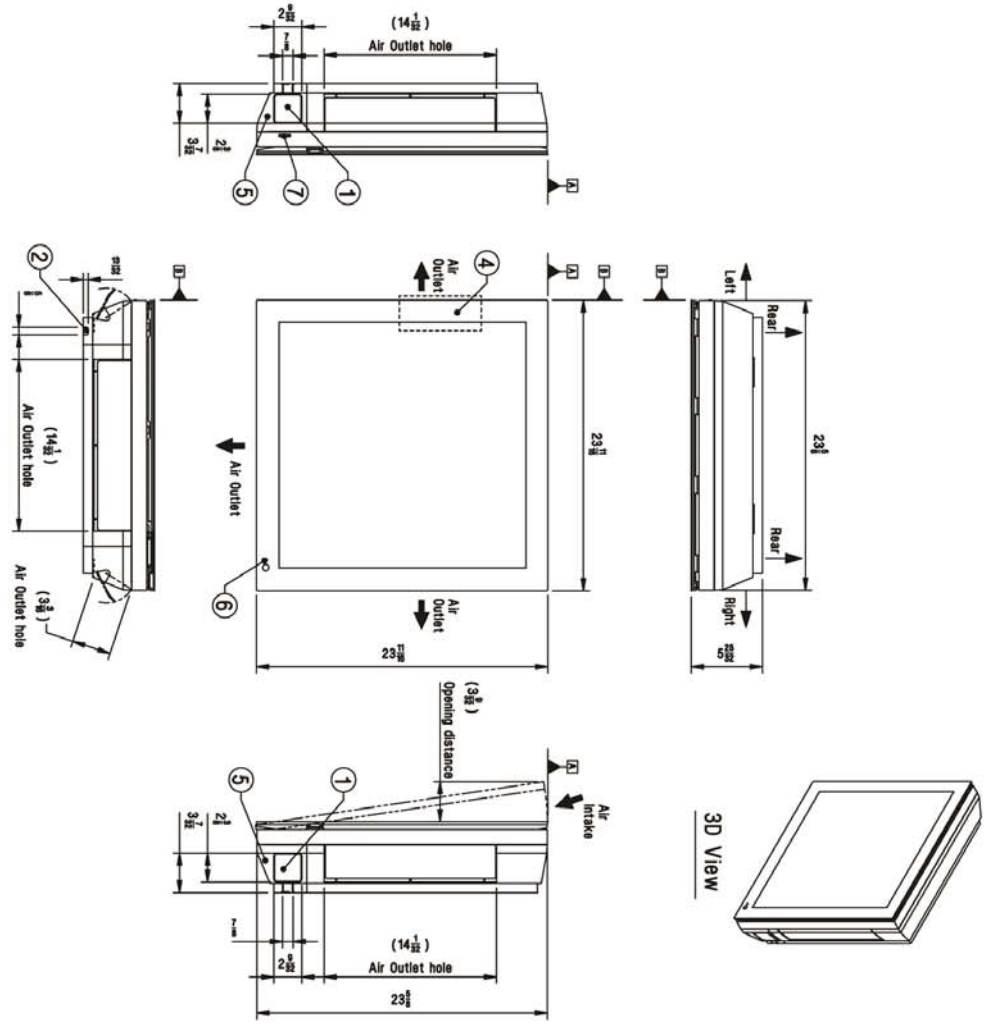

No.	Part Name	Description
1	Refrigerant/drain pipe and cable routing hole	Knock-out type
2	Cable routing hole	-
3	Drain hose connection	-
4	Terminal block for power supply and communication	Inside of front panel
5	Corner cover	-
6	Remote controller signal receiver	For wireless Type
7	Forced ON/OFF button	-