



OWNER'S MANUAL

AIR CONDITIONER



Read this owner's manual thoroughly before operating the appliance and keep it handy for reference at all times.

TYPE: WALL MOUNTED

ENGLISH



ENERGY STAR

If Indoor unit are connected with multi split type, It is not Energy Star certified products



MFL69491102
Rev.12_020521

www.lg.com

Copyright © 2017 - 2021 LG Electronics Inc. All Rights Reserved

TABLE OF CONTENTS

2 TABLE OF CONTENTS

3 SAFETY INSTRUCTIONS

3 IMPORTANT SAFETY INSTRUCTIONS

7 OPERATION

7 Notes for Operation
7 Parts and Functions
8 Wireless Remote Control
13 Restarting the Air Conditioner Automatically
13 Using the Mode Function
15 Using the Jet Mode Function
16 Using the Fan Speed Function
16 Using the Air Flow Direction Function
17 Setting the On/Off Timer
18 Using the Sleep Function (Optional)
18 Using the Simple Timer Function (Optional)
19 Using the Energy Display Function (Optional)
19 Using the Light Off Function (Optional)
19 Using the Comfort Air Function (Optional)
20 Using the Energy Saving Function (Optional)
20 Using the Energy Control Function (Optional)
21 Using Special Functions

24 SMART FUNCTIONS

24 LG ThinQ Application
26 Smart Diagnosis™

27 MAINTENANCE

29 Clean the Air Filter
30 Clean the Micro Dust and Triple Filter (Optional)

31 TROUBLESHOOTING

35 WARRANTY (USA)

37 WARRANTY (CANADA)

SAFETY INSTRUCTIONS

READ ALL INSTRUCTIONS BEFORE USE

Your safety and the safety of others are very important.

We have provided many important safety messages in this manual and on your appliance. Always read and follow all safety messages.

 This is the safety alert symbol.

This symbol alerts you to potential hazards that can kill or injure you and others.

All safety messages will follow the safety alert symbol and either the word **WARNING**, or **CAUTION**.

WARNING

If you do not follow instructions, it could result in death or serious injury.

CAUTION

If you do not follow instructions, it could result in minor or moderate injury or damage to the product.

All safety messages will tell you what the potential hazard is, tell you how to reduce the chance of injury, and tell you what may happen if the instructions are not followed.

IMPORTANT SAFETY INSTRUCTIONS

WARNING

To reduce the risk of explosion, fire, death, electric shock, injury or scalding to persons when using this product, follow basic precautions, including the following:

- Installation or repairs made by unauthorized persons can pose hazards to you and others.
- Installation **MUST** conform to the local building codes or, in the absence of local codes, the National Electrical Code NFPA 70/ANSI C1-1003 or current edition and Canadian Electrical Code Part1 CSA C.22. 1.
- The information contained in the manual is intended for use by a qualified service technician who is familiar with the safety procedures and equipped with the proper tools and test instruments.
- Failure to read and follow all instructions in this manual can result in equipment malfunction, property damage, personal injury and/or death.
- When the power cord is to be replaced, the replacement work shall be performed by authorized personnel using only genuine replacement parts.
- This appliance is not intended for use by persons (including children) with reduced physical, sensory or mental capabilities, or lack of experience and knowledge, unless they have been given supervision or instruction concerning use of the appliance by a person responsible for their safety. Children should be supervised to ensure that they do not play with the appliance.

Installation

- Do not install the air conditioner on an unstable surface or in a place where there is danger of it falling.
- Contact an authorized service center when installing or relocating the air conditioner.
- Install the panel and the cover of the control box safely.
- Do not install the air conditioner in a place where flammable liquids or gases such as gasoline, propane, paint thinner, etc., are stored.
- Make sure that the pipe and the power cable connecting the indoor and outdoor units are not pulled too tight when installing the air conditioner.
- Use standard circuit breaker and fuse that conform to the rating of the air conditioner.
- Do not input air or gas into the system except with the specific refrigerant.
- Use non-flammable gas (nitrogen) to check for leak and to purge air; using compressed air or flammable gas may cause fire or explosion.
- The indoor/outdoor wiring connections must be secured tightly, and the cable should be routed properly so that there is no force pulling the cable from the connection terminals. Improper or loose connections can cause heat generation or fire.
- Install dedicated electric outlet and circuit breaker before using the air conditioner.
- Do not connect the ground wire to a gas pipe, a lightning rod, or a telephone ground wire.
- If the supply cord is damaged, it must be replaced by the manufacturer, its service agent or similarly qualified person in order to avoid a hazard.
- Do not install the unit in potentially explosive atmospheres.

Operation

- Be sure to use only those parts listed in the service parts list. Never attempt to modify the equipment.
- Make sure that children do not climb on or hit the outdoor unit.
- Dispose of the batteries in a place where there is no danger of fire.
- Use only the refrigerant specified on the air conditioner label.
- Cut off the power supply if there is any noise, smell, or smoke coming from the air conditioner.
- Do not leave flammable substances such as gasoline, benzene, or thinner near the air conditioner.
- Contact an authorized service center when the air conditioner is submerged by flood waters.
- Do not use the air conditioner for an extended period of time in a small place without proper ventilation.
- In the event of a gas leak (such as Freon, propane gas, LP gas, etc.) ventilate sufficiently before using the air conditioner again.
- To clean the interior, contact an authorized service center or dealer. Using harsh detergents may cause corrosion or damage to the unit.

- Be sure to ventilate sufficiently when the air conditioner and a heating appliance such as a heater are used simultaneously.
- Do not block the inlet or outlet of air flow.
- Do not insert hands or other objects through the air inlet or outlet while the air conditioner is operating.
- Make sure that the power cable is neither dirty, loose, nor broken.
- Never touch, operate, or repair the air conditioner with wet hands.
- Do not place any objects on the power cable.
- Do not place a heater or other heating appliances near the power cable.
- Do not modify or extend the power cable. Scratches or peeling insulation on the power cables may result in fire or electric shock, and should be replaced.
- Cut off the power supply immediately in the event of a blackout or a thunderstorm.
- Take care to ensure that power cable could not be pulled out or damaged during operation.
- Do not touch refrigerant pipe, water pipe and any internal parts while the unit is operating or immediately after operation.

Maintenance

- Do not clean the appliance by spraying water directly onto the product.
- Before cleaning or performing maintenance, disconnect the power supply and wait until the fan stops.

CAUTION

To reduce the risk of minor injury to persons, malfunction, or damage to the product or property when using this product, follow basic precautions, including the following:

Installation

- Do not install the air conditioner in an area where it is directly exposed to sea wind (salt spray).
- Install the drain hose properly for the smooth drainage of water condensation.
- Exercise caution when unpacking or installing the air conditioner.
- Do not touch the leaking refrigerant during installation or repair.
- Transport the air conditioner with two or more people or use a forklift.
- Install the outdoor unit such that it is protected from direct sunlight. Do not place the indoor unit in a place where it is directly exposed to sunlight via the windows.
- Safely dispose of packing materials such as screws, nails, plastic bag or batteries using proper packaging after installation or repair.
- Install the air conditioner in a place where the noise from the outdoor unit or the exhaust fumes will not inconvenience the neighbors. Failure to do so may result in conflict with the neighbors.

Operation

- Remove the batteries if the remote control is not to be used for an extended period of time.
- Make sure that the filter is installed before operating the air conditioner.
- Be sure to check if there is a refrigerant leak after installing or repairing the air conditioner.
- Follow the standards of the corresponding region or country for handling the refrigerant and the air conditioner and for disassembling the air conditioner.
- Do not place any object on the air conditioner.
- Never mix different types of batteries, or old and new batteries for the remote control.
- Do not let the air conditioner run for a long time when humidity is very high or when a door or a window has been left open.
- Stop using the remote control if there is a fluid leak in the battery. If your clothes or skin are exposed to the leaking battery fluid, wash off with clean water.
- Do not expose people, animals, or plants to the cold or hot wind from the air conditioner for extended periods of time.
- If the leaking battery fluid has been swallowed, rinse the inside of the mouth thoroughly and consult a doctor.
- Do not drink the water drained from the air conditioner.
- Do not use the product for special purposes, such as preserving foods, works of art, and etc. It is an air conditioner for consumer purposes, not a precision refrigeration system. There is risk of damage or loss of property.
- Do not recharge or disassemble the batteries.

Maintenance

- Never touch the metal parts of the air conditioner when removing the air filter.
- Use a sturdy stool or ladder when cleaning, maintaining, or repairing the air conditioner at a height.
- Never use strong cleaning agents or solvents when cleaning the air conditioner or spray water. Use a smooth cloth.

OPERATION

Notes for Operation

Suggestion for Energy Saving

- Do not over-cool the space. This may be harmful for your health and may consume more electricity.
- Block sunlight with blinds or curtains while you are operating the air conditioner.
- Keep doors or windows closed tightly while you are operating the air conditioner.
- Adjust the direction of the air flow vertically or horizontally to circulate indoor air.
- Speed up the fan to cool or warm indoor air quickly, within a short period of time.
- Open windows regularly for ventilation. The indoor air quality may deteriorate if the air conditioner is used for long durations.
- Clean the air filter once every 2 weeks. Dust and impurities collected in the air filter may block the air flow or reduce the unit performance.

Parts and Functions

Indoor Unit

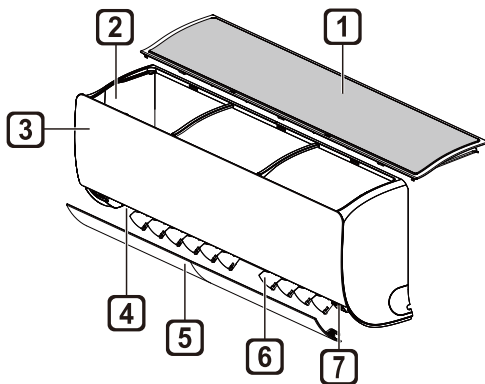

- 1 Air Filter
- 2 Air Intake
- 3 Front Cover
- 4 Air Outlet
- 5 Air Deflector (Horizontal Vane)
- 6 Air Deflector (Vertical Louver)
- 7 On/Off Button

Outdoor Unit

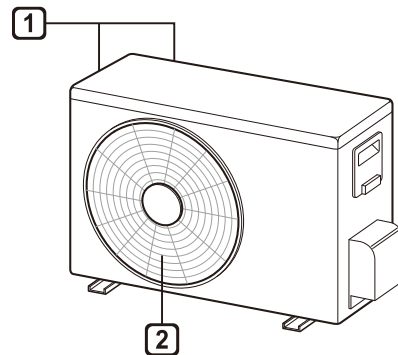

- 1 Air Intake Vents
- 2 Air Outlet Vents

NOTE

- The number and location of operation lamps may vary according to the model of the air conditioner.
- The feature may be changed according to the type of model.

Wireless Remote Control

Inserting Batteries

If the display screen of the remote control begins to fade, replace the batteries. Insert AAA (1.5 V) batteries before using the remote control.

- 1 Remove the battery cover.

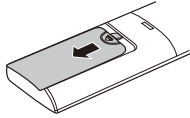

- 2 Insert the new batteries and make sure that the + and - terminals of the batteries are installed correctly.

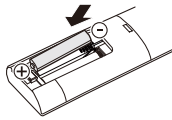

Installing the Remote Control Holder

To protect the remote control, install the holder where there is no direct sunlight.

- 1 Choose a safe and easily accessible location.
- 2 Fix the holder by fastening 2 screws firmly with a screwdriver.

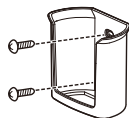

Operating Method

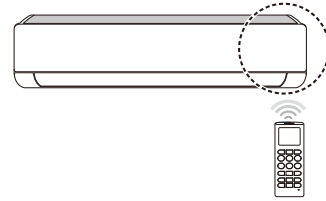

Point the remote control towards the signal receiver at the right side of the air conditioner to operate it.



NOTE

- The remote control may operate other electronic devices if it is directed towards them. Make sure to point the remote control towards the air conditioner signal receiver.
- For proper operation, use a soft cloth to clean the signal transmitter and receiver.
- In case of a function not provided in the product, no buzzer sound occurs from the product when a button for such function on the remote control is pressed except for Air Flow Direction (SWING), Energy Display (kW_[3-5]), Air Purification function ().

Setting the Current Time

- 1 Insert batteries.
 - The icon below blinks at the bottom of the display screen.
- 
- 2 Press  or  button to select the minutes.
 - 3 Press **SET/CANCEL** button to finish.

NOTE

- The On/Off Timer is available after setting the current time.

Using the °C/°F Conversion Function (Optional)

This function changes unit between °C and °F

- Press and hold  button about 5 seconds.

Operating the Air Conditioner without the Remote Control

You can use the **ON/OFF** button of the indoor unit to operate the air conditioner when the remote control is unavailable.

- 1 Open the front cover (Type2) or horizontal vane (Type1).
- 2 Press the **ON/OFF** button.

Type1

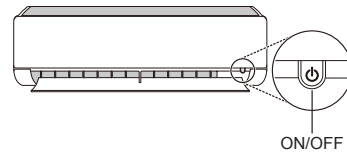

Type2

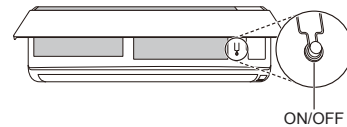

NOTE

- The stepping motor may be broken, if the horizontal vane opens rapidly.
- The fan speed is set to high.
- The feature may be changed according to the type of model.
- The temperature cannot be altered when using this emergency **ON/OFF** button.
- For cooling & heating models, the temperature is set from 22 °C to 24 °C

Using Wireless Remote Control

You can operate the air conditioner more conveniently with the remote control.

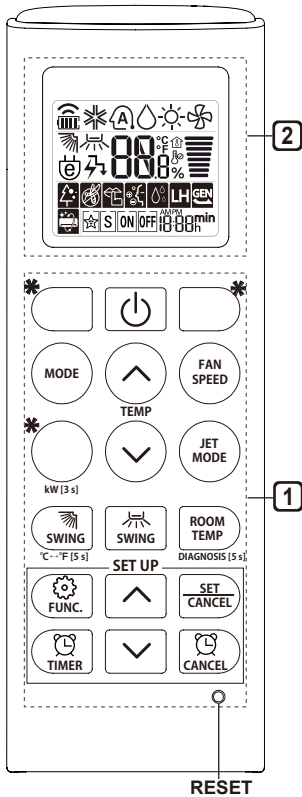

1 Button	2 Display Screen	Description	Available Function	
			Single Split	Multi
	-	To turn on/off the air conditioner.	○	○
	88 ^{°C}	To adjust the desired room temperature in cooling, heating or auto changeover mode.	○	○
MODE		To select the cooling mode.	○	○
		To select the heating mode.	○	○
		To select the dehumidification mode.	○	○
		To select the fan mode.	○	○
		To select the auto changeover/auto operation mode.	○	○
JET MODE		To change room temperature quickly.	○	○
FAN SPEED		To adjust the fan speed.	○	○
		To adjust the air flow direction vertically or horizontally.	○	○

NOTE



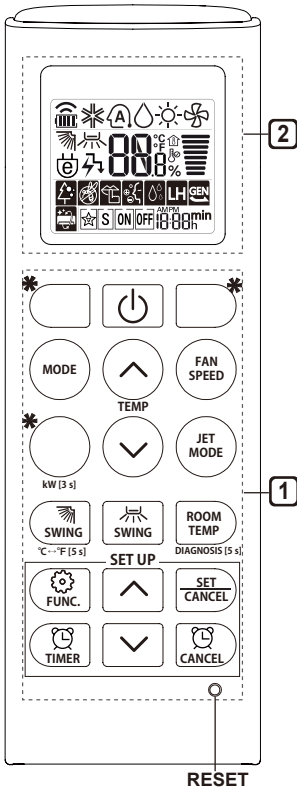



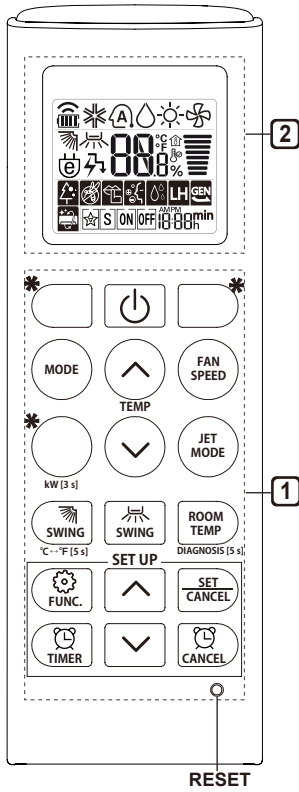

- * buttons may be changed according to the type of model.
- When connected to the Multi Outdoor unit, the Energy Display, Energy Control, Silent and Smart Diagnosis function may not be supported.



1 Button	2 Display Screen	Description	Available Function	
			Single Split	Multi
	 	To turn on/off air conditioner automatically at desired time.	○	○
SET/ CANCEL	-	To set/cancel the special functions and timer.	○	○
	-	To cancel the timer settings.	○	○
	-	To adjust time.	○	○
*LIGHT OFF	-	To set the brightness of the display on the indoor unit.	○	○
ROOM TEMP		To display the room temperature.	○	○
°C↔°F [5 s]		To change unit between °C and °F	○	○
*ENERGY SAVING		To minimize power consumption.	○	○
*COMFORT AIR		To adjust the air flow to deflect wind.	○	○
kW [3 s]	-	To set whether or not to display information regarding energy.	○	X
*ENERGY CTRL		To bring the effect of the power saving.	X	X
*COMFORT SLEEP		To make a comfortable sleeping environment.	○	X
DIAGNOSIS [5 s]	-	To conveniently check maintenance information of a product.	○	○

RESET



1 Button	2 Display Screen	Description	Available Function	
			Single Split	Multi
		The Ion generator uses millions of ions to help improve indoor air quality.	X	X
		To reduce noise from outdoor units.	X	X
		To keep your skin moisturized by generating ion clusters.	X	X
		To lower indoor humidity quickly.	X	X
		To maintain a minimum room temperature and prevent objects in the room from freezing.	O (Optional)	X
		To scare away a mosquito.	X	X
		To remove moisture generated inside the indoor unit.	O	O
		To make a comfortable sleeping environment.	X	X
RESET	-	To initialize the remote control settings.	O	O

NOTE

- Some functions may not be supported, depending on the model.
- * buttons may be changed according to the type of model.
- Press the **SET/CANCEL** button to operate the selected **FUNC.**

Restarting the Air Conditioner Automatically

When the air conditioner is turned on again after a power failure, this function restores the previous settings.

Disabling Auto Restart

- 1 Open the front cover (Type2) or horizontal vane (Type1).
- 2 Press the **ON/OFF** button and hold it for 6 seconds, then the unit will beep twice and the lamp will blink twice 4 times.
 - To re-enable the function, press the **ON/OFF** button and hold it for 6 seconds. The unit will beep twice and the lamp will blink 4 times.

Type1

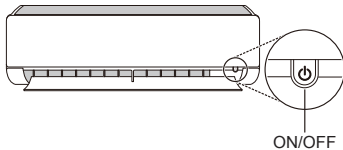

Type2

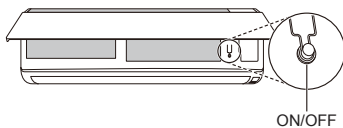

NOTE

- The feature may be changed according to the type of model.
- If you press and hold the **ON/OFF** button for 3 – 5 seconds, instead of 6 seconds, the unit will switch to the test operation. In the test operation, the unit blows out strong cooling air for 18 minutes and then returns to factory default settings.

Using the Mode Function

This function allows you to select the desired function.

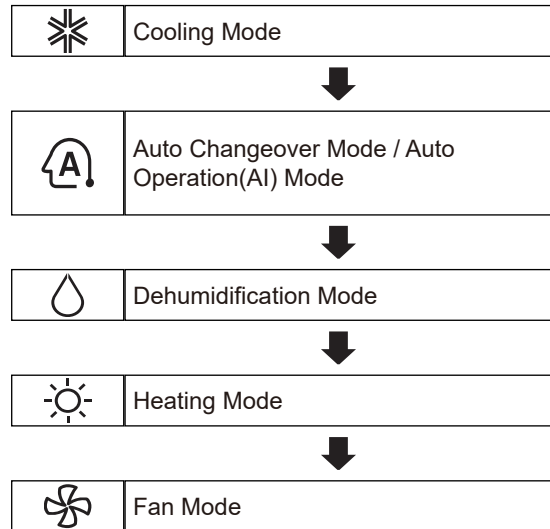



Cooling Mode

- 1 Turn the appliance on.
- 2 Press **MODE** button repeatedly to select the Cooling Mode.
 - ❄️ is displayed on the display screen.
- 3 Press or button to set the desired temperature.

Auto Operation (Artificial Intelligence)

Multi Model



In this operation mode, the system is automatically operated by the electronic controls.

- 1 Turn the appliance on.
- 2 Press **MODE** button repeatedly to select the Auto Operation.
 -  is displayed on the display screen.
- 3 Press  or  button to set the desired temperature.
- 4 Press **FAN SPEED** button to adjust the fan speed.

Auto Changeover Mode

Single Split Model

This mode changes the mode automatically to maintain the set temperature at ± 2 °C

- 1 Turn the appliance on.
- 2 Press **MODE** button repeatedly to select the Auto Changeover Mode.
 -  is displayed on the display screen.
- 3 Press  or  button to set the desired temperature.
- 4 Press **FAN SPEED** button to adjust the fan speed.

Dehumidification Mode



This mode removes excess moisture from a highly humid environment or during the rainy season, in order to prevent mildew from setting in. This mode adjusts the room temperature and the fan speed automatically to maintain the optimal level of humidity.

- 1 Turn the appliance on.
- 2 Press **MODE** button repeatedly to select the Dehumidification Mode.
 -  is displayed on the display screen.

NOTE

- In this mode you cannot adjust the room temperature, it is adjusted automatically.
- The room temperature is not displayed on the display screen.
- In the dehumidification mode, compressor and indoor fan may not operate when the room temperature is below 24 °C

Heating Mode

- 1 Turn the appliance on.
- 2 Press **MODE** button repeatedly to select the Heating Mode.
 -  is displayed on the display screen.
- 3 Press  or  button to set the desired temperature.

NOTE

-  will be displayed on the indoor unit when defrosting is operating.
- Furthermore, this indication will be displayed on the indoor unit:
 - When preheating is operating.
 - When the room temperature has been reached to the set temperature.

Fan Mode

This mode only circulates the indoor air without changing the room temperature.

- 1 Turn the appliance on.
- 2 Press **MODE** button repeatedly to select the Fan Mode.
 -  is displayed on the display screen.
- 3 Press **FAN SPEED** button to adjust the fan speed.

Using the Jet Mode Function





Changing Room Temperature Quickly

This function allows you to cool indoor air quickly during the summer or warm it quickly during winter.

- The Jet Mode function is available with Cooling, Heating and Dehumidification Mode.

- 1 Turn the appliance on.
- 2 Press **MODE** button repeatedly to select the desired mode.
- 3 Press **JET MODE** button.
 -  is displayed on the display screen.





NOTE

- Jet Heating Mode is not available on some models.
- In Jet Cooling Mode, strong air blows out for 30 minutes.
 - After 30 minutes later, setting temperature is maintaining 18 °C
If you want to change the temperature, Press  or  button to set the desired temperature.
- In Jet Heating Mode, strong air blows out for 30 minutes.
 - After 30 minutes later, setting temperature is maintaining 30 °C
If you want to change the temperature, Press  or  button to set the desired temperature.
- This function may operate differently from the remote control display.

Using the Fan Speed Function

Adjusting the Fan Speed

- Press **FAN SPEED** button repeatedly to adjust the fan speed.

Display Screen	Speed
	High
	Medium - High
	Medium
	Medium - Low
	Low
-	Natural Wind

NOTE

- The fan speed of Natural Wind adjusts automatically.





- The fan speed icons are displayed on some indoor units.

F1 → F2 → F3 → F4 → F5



- Indoor unit display is displayed only 5 seconds and return to the setting temperature on some models.

Using the Air Flow Direction Function

This function adjusts the direction of the air flow vertically (horizontally).

- Press   button repeatedly and select the desired direction.
 - Select  to adjust the direction of the air flow automatically.

NOTE

- Adjusting the air flow direction horizontally may not be supported, depending on the model.
- Adjusting the air deflector arbitrarily may cause product failure.
- If you restart the air conditioner, it starts to operate with the previously set direction of air flow, so the air deflector may not match the icon displayed on the remote control. When this occurs, press  or  button to adjust the direction of the air flow again.
- This function may operate differently from the remote control display.

Setting the On/Off Timer



This function sets the air conditioner to turn on/off automatically at desired time.

On/Off Timer can be set together.

Setting the On Timer

- 1 Press  button repeatedly.
 - The icon below blinks at the bottom of the display screen.



- 2 Press  or  button to select the minutes.
- 3 Press **SET/CANCEL** button to finish.
 - After setting the timer, current time and  icon are displayed on the display screen indicating that the desired time is set.

Canceling the On Timer

- 1 Press  button repeatedly.
 - The icon below blinks at the bottom of the display screen.





- 2 Press **SET/CANCEL** button to cancel the setting.

Setting the Off Timer

- 1 Press  button repeatedly.
 - The icon below blinks at the bottom of the display screen.



- 2 Press  or  button to select the minutes.
- 3 Press **SET/CANCEL** button to finish.
 - After setting the timer, current time and  icon are displayed on the display screen indicating that the desired time is set.

NOTE

- This function is disabled when you set Simple Timer.

Canceling the Off Timer

- 1 Press  button repeatedly.
 - The icon below blinks at the bottom of the display screen.



- 2 Press **SET/CANCEL** button to cancel the setting.

Canceling the Timer Setting



- Press  button to cancel all timer settings.

Using the Sleep Function (Optional)

This function turns off the air conditioner automatically when you go to sleep.

- 1 Turn the appliance on.
- 2 Press  button repeatedly.
 - The icon below blinks at the bottom of the display screen.



- 3 Press  or  button to select the hour (up to 7 hours).
- 4 Press **SET/CANCEL** button to finish.
 -  is displayed on the display screen.

NOTE



-  is displayed on some indoor units.
- Indoor unit display is displayed from 1H to 7H which is displayed only 5 seconds and then return to the setting temperature.
- In the Cooling and Dehumidification Mode, the temperature increases by 1 °C after 30 minutes and additional 1 °C after another 30 minutes for a more comfortable sleep.
- The temperature increases up to 2 °C from the preset temperature.
- Although the remark for fan speed on the display screen may be changed, the fan speed is adjusted automatically.

Using the Simple Timer Function (Optional)

This function turns off the air conditioner automatically when you go to sleep.

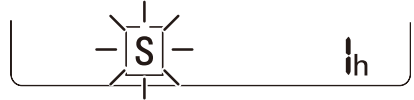
- 1 Turn the appliance on.
- 2 Press  button repeatedly.
 - The icon below blinks at the bottom of the display screen.



- 3 Press  or  button to select the hour (up to 7 hours).
- 4 Press **SET/CANCEL** button to finish.
 -  is displayed on the display screen.



NOTE

- This function is disabled when you set Off Timer.

Using the Energy Display Function (Optional)

This function displays the amount of electricity generated on the indoor display as the product operates.

Display the Current Energy Usage

- 1 Turn the appliance on.
- 2 Press  button and hold it about 3 seconds.
 - The instantaneous power consumption () is displayed for a while on some indoor units.

NOTE

- It is not displayed on the wireless remote control.
- The unit of the displayed value is kW.
- If it is more than 99 kW, which is the range of expression, maintain it as 99 kW.
- Display wattage under 10 kW with 0.1 kW unit, and display one over 10 kW with 1 kW unit.
- The actual power may differ from the power displayed.
- When connected to the Multi Outdoor unit, this function may not be supported.

Using the Light Off Function (Optional)

Display Screen Brightness

You can set the brightness of the indoor unit display screen.

- Press **LIGHT OFF** button.



NOTE

- Turn on/off the Display screen.



Using the Comfort Air Function (Optional)

Comfort Vane Operation

This function conveniently sets the vane to a preset position to deflect the supply air away from blowing directly onto the occupants in the room.

- 1 Turn the appliance on.
- 2 Press **COMFORT AIR** button repeatedly and select the desired direction.
 -  or  is displayed on the display screen.

NOTE

-  or  is displayed on some indoor units.
- This function is disabled when you press **MODE** or **JET MODE** button.
- This function is disabled and auto swing of vertical direction is set up when you press  button.
- When this function is off, the horizontal vane operates automatically depending on the set mode.

Using the Energy Saving Function (Optional)







This function minimizes power consumption during Cooling and increases the set temperature to the optimal level for a more comfortable environment. The temperature automatically settles at 22 °C if desired temperature is below 22 °C. The temperature remains constant if it is above 22 °C.

- 1 Turn the appliance on.
- 2 Press **MODE** button repeatedly to select the Cooling Mode.
- 3 Press **ENERGY SAVING** button.
 -  is displayed on the display screen.

Using the Energy Control Function (Optional)

- 1 Turn the appliance on.
- 2 Press **ENERGY CTRL** button.
 - Press **ENERGY CTRL** button repeatedly to select each step.

NOTE

- 1 step : The power Input is decreased by 20 % compared to rated power input.
 -  % is displayed on the display screen.
- 2 step : The power Input is decreased by 40 % compared to rated power input.
 -  % is displayed on the display screen.
- 3 step (Optional) : The power Input is decreased by 60 % compared to rated power input.
 -  % is displayed on the display screen.
-  (1 step),  (2 step) is displayed on some indoor units.
- This function is available with Cooling Mode.
- Capacity may decrease when Energy Control mode is selected.
- Desired temperature is displayed about 5 seconds if you press **FAN SPEED**,  or  button.
- Room temperature is displayed about 5 seconds if you press **ROOM TEMP** button.

Using Special Functions

- 1 Turn the appliance on.
- 2 Press **FUNC** button repeatedly to select the desired function.
- 3 Press **SET/CANCEL** button to finish.

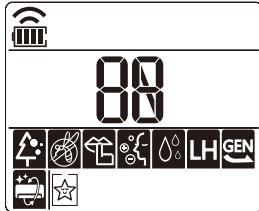

Display Screen	Description	Available Function	
		Single Split	Multi
	The Ion generator uses millions of ions to help improve indoor air quality.	X	X
	To reduce noise from outdoor units.	X	X
	To keep your skin moisturized by generating ion clusters.	X	X
	To lower indoor humidity quickly.	X	X
	To maintain a minimum room temperature and prevent objects in the room from freezing.	O (Optional)	X
	To scare away a mosquito.	X	X
	To remove moisture generated inside the indoor unit.	O	O
	To make a comfortable sleeping environment.	X	X

NOTE

- Some functions may not be supported, depending on the model.
- Some functions may operate differently from the remote control display.

Canceling Special Functions

- 1 Press **FUNC** button repeatedly to select the desired function.
- 2 Press **SET/CANCEL** button to cancel the function.

Using the Air Purification Function

These functions supply clean and fresh air by ion particles and the filter.

Function	Display	Description
Ionizer		Ion particles from ionizer reduce the surface bacteria and other harmful substances.
Plasma		It removes microscopic contaminants from the intake air completely to supply clean and fresh air.

NOTE

- You can use this function without turning the air conditioner on.
- Both the plasma lamp and the cooling lamp light up while Smoke Away/Plasma is in operation on some models.
- Do not touch ionizer during operation.
- This function may operate differently from the remote control display.

Using the Silent Function (Optional)

This function prevents potential claims by neighbors, reducing noise from outdoor units.

-  is displayed on the display screen.

NOTE

- This function is disabled when you press **MODE** or **ENERGY CTRL** or **JET MODE** button.
- This function is available with Cooling, Heating, Auto Changeover, Auto Operation Mode.

Using the Ion Care Function (Optional)

This function keeps your skin moisturized by generating ion clusters which is absorbed into the surface of skin.

-  is displayed on the display screen about 3 seconds.

NOTE

- This function is available with Cooling, Fan Mode and Air Purification function.

Using the Jet Dry Function (Optional)

This function maximizes the performance of dehumidification.

-   are displayed on the display screen.

NOTE



- This function is available with Cooling, Dehumidification, Auto Operation, Fan Mode and Air Purification function.
- This function is not available with Sleep function.
- This function is disabled when you press **MODE** button.

Using the Low Heating Function (Optional)

This function operates the heating system to maintain a minimum room temperature and prevent objects in the room from freezing where there is no permanent resident, such as a vacation.

-  LH are displayed on the display screen.

NOTE

- This function is available with Heating Mode.
- During LH operation, when you press buttons such as , , **MODE**, **FAN SPEED**, and then return to Heating Mode.
- If **JET MODE** button is pressed during LH operation, this function is disabled and Power Heating Mode is operated immediately. (only for power heating model)
- In case an error occurred, operation can be interrupted for the protection of the product.
- **COMFORT AIR** and  button cannot be used while the LH function is in operation.

Using the Mosquito Away Function (Optional)

This function fans away mosquitos by generating a high-frequency wave.

-  is displayed on the display screen.

NOTE

- You can use this function without turning the air conditioner on.
-  is displayed on some indoor units.

Using the Auto Clean Function

In the Cooling and Dehumidification Mode, moisture is generated inside the indoor unit. This function removes such moisture.

-  is displayed on the display screen.

NOTE

- Some functions cannot be used while the Auto Clean function is in operation.
- If you turn off the unit, the fan continues to run for 30 minutes and cleans the inside of the indoor unit.
-  is displayed on some indoor units, depending on the model.

Using the Comfort Sleep Function (Optional)

This function operates the air conditioner automatically to make the comfortable sleep environment.

- , SL are displayed on the display screen.

NOTE

- This function is available with Cooling Mode.
- The vane stops swing and sets indirect airflow angle, after 30 minutes from start even though the room temperature doesn't decrease to optimal temperature to sleep.
- It is possible that a comfortable sleep environment is different according to the people.

SMART FUNCTIONS

LG ThinQ Application

This feature is only available on models with the  or **ThinQ** logo.

The **LG ThinQ** application allows you to communicate with the appliance using a smartphone.

LG ThinQ Application Features

Communicate with the appliance from a smartphone using the convenient smart features.

Smart Diagnosis™

If you experience a problem while using the appliance, this smart diagnosis feature will help you diagnose the problem.

Settings

Allows you to set various options on the appliance and in the application.

NOTE

- If you change your wireless router, internet service provider, or password, delete the registered appliance from the **LG ThinQ** application and register it again.
- The application is subject to change for appliance improvement purposes without notice to users.
- Functions may vary by model.

Before Using LG ThinQ Application

- 1 Check the distance between the appliance and the wireless router (Wi-Fi network).
 - If the distance between the appliance and the wireless router is too far, the signal strength becomes weak. It may take a long time to register or installation may fail.

- 2 Turn off the **Mobile data** or **Cellular Data** on your smartphone.

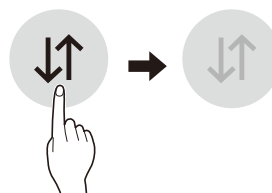

- 3 Connect your smartphone to the wireless router.

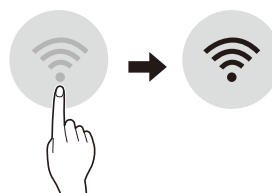

NOTE

- To verify the Wi-Fi connection, check that  icon on the control panel is lit.
- The appliance supports 2.4 GHz Wi-Fi networks only. To check your network frequency, contact your Internet service provider or refer to your wireless router manual.
- **LG ThinQ** is not responsible for any network connection problems or any faults, malfunctions, or errors caused by network connection.
- If the appliance is having trouble connecting to the Wi-Fi network, it may be too far from the router. Purchase a Wi-Fi repeater (range extender) to improve the Wi-Fi signal strength.
- The Wi-Fi connection may not connect or may be interrupted because of the home network environment.
- The network connection may not work properly depending on the Internet service provider.
- The surrounding wireless environment can make the wireless network service run slowly.

- The appliance cannot be registered due to problems with the wireless signal transmission. Unplug the appliance and wait about a minute before trying again.
- If the firewall on your wireless router is enabled, disable the firewall or add an exception to it.
- The wireless network name (SSID) should be a combination of English letters and numbers. (Do not use special characters.)
- Smartphone user interface (UI) may vary depending on the mobile operating system (OS) and the manufacturer.
- If the security protocol of the router is set to **WEP**, you may fail to set up the network. Please change it to other security protocols (**WPA2** is recommended) and register the product again.

Installing the LG ThinQ Application

Search for the **LG ThinQ** application from the Google Play Store or Apple App Store on a smartphone. Follow instructions to download and install the application.



Open Source Software Notice Information

To obtain the source code under GPL, LGPL, MPL, and other open source licenses, that is contained in this product, please visit <https://opensource.lge.com>.

In addition to the source code, all referred license terms, warranty disclaimers and copyright notices are available for download.

LG Electronics will also provide open source code to you on CD-ROM for a charge covering the cost of performing such distribution (such as the cost of media, shipping, and handling) upon email request to opensource@lge.com. This offer is valid for a period of three years after our last shipment of this product. This offer is valid to anyone in receipt of this information.

Smart Diagnosis™

This feature is only available on models with the  or  logo.

Use this feature to help you diagnose and solve problems with your appliance.

NOTE

- For reasons not attributable to LGE's negligence, the service may not operate due to external factors such as, but not limited to, Wi-Fi unavailability, Wi-Fi disconnection, local app store policy, or app unavailability.
- The feature may be subject to change without prior notice and may have a different form depending on where you are located.

Using LG ThinQ to Diagnose Issues



If you experience a problem with your Wi-Fi equipped appliance, it can transmit troubleshooting data to a smartphone using the **LG ThinQ** application.

- Launch the **LG ThinQ** application and select the **Smart Diagnosis™** feature in the menu. Follow the instructions provided in the **LG ThinQ** application.

Using Audible Diagnosis to Diagnose Issues

Follow the instructions below to use the audible diagnosis method.

- Launch the **LG ThinQ** application and select the **Smart Diagnosis™** feature in the menu. Follow the instructions for audible diagnosis provided in the **LG ThinQ** application.

- 1 Plug the power plug in the outlet properly.
- 2 Place the mouthpiece of your smartphone close to the  or  logo.
- 3 Press and hold the **DIAGNOSIS [5 s]** button for 5 seconds or longer while holding the smartphone mouthpiece to the logo until the data transfer is complete.
 - Keep the smartphone in place until the data transfer has finished. Time remaining for data transfer is displayed.
- 4 After the data transfer is complete, the diagnosis will be displayed in the application.

NOTE

- For best results, do not move the phone while the tones are being transmitted.
- Be sure to keep ambient noise to a minimum or the phone may not correctly receive the buzzer beeps from the indoor unit.

MAINTENANCE

WARNING

- Before cleaning or performing maintenance, disconnect the power supply and wait until the fan stops.

If the air conditioner will not be used for an extended period of time, dry the air conditioner to maintain it in best condition. Clean the product regularly to maintain optimal performance and to prevent possible breakdown.

- Dry the air conditioner in Fan mode for 3 to 4 hours and disconnect the power. There may be internal damage if moisture is left in its components.
- Before using the air conditioner again, dry the inner components of the air conditioner in Fan mode for 3 to 4 hours. This will help to remove the odor generated from moisture.

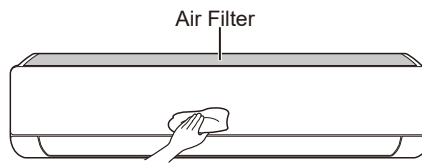

- The feature may be changed according to the type of model.

Type	Description	Interval
Air filter	Clean with a vacuum or hand wash.	2 weeks
Triple filter	Clean with a vacuum or brush.	Every 3 months
Micro dust filter	Clean with a vacuum or brush.	Once a month
Ionizer (Optional)	Use dry cotton bud to remove any dust.	Every 6 months
Indoor unit	Clean the Indoor unit surface by using a soft, dry cloth.	Regularly
	Have a professional clean the condensate drain pan.	Once a year
	Have a professional clean the condensate drain pipe.	Every 4 months
	Replace the remote control batteries.	Once a year
Outdoor unit	Have a professional clean the heat exchanger coils and the panel vents. (Consult with technician.)	Once a year
	Have a professional clean the fan.	Once a year
	Have a professional clean the condensate drain pan.	Once a year
	Have a professional verify that all the fan assembly is firmly tightened.	Once a year
	Clean the electric components with air.	Once a year

NOTE

- Never use water that is higher than 40 °C when you clean the filters. It may cause deformation or discoloration.
- Never use volatile substances when you clean the filters. They may damage the surface of the product.
- Do not wash the Micro dust filter with water, because the filter can be damaged (Optional).
- Do not wash the Triple filter with water, because the filter can be damaged (Optional).

Clean the Air Filter

Clean the air filters once every 2 weeks, or more, if necessary.

NOTE

- The air filter can be broken when it is bent.
- When the air filter is not assembled correctly, dust and other substances can enter into the indoor unit.

Type1

If you look at the indoor unit from above it, can assemble the top filter easily.

- 1 Turn off the power to the unit.
- 2 Hold the knobs of the air filter, lift it up slightly.

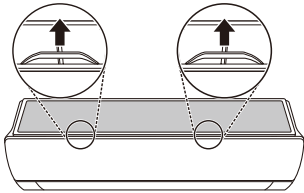

- 3 Remove it from the indoor unit.

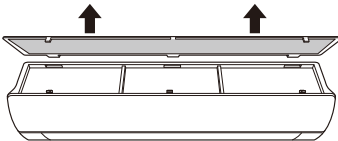

- 4 Clean the filter with a vacuum cleaner or with lukewarm water with neutral detergent.
- 5 Dry the filter in the shade.
- 6 Insert the hooks of the air filter into the front cover.

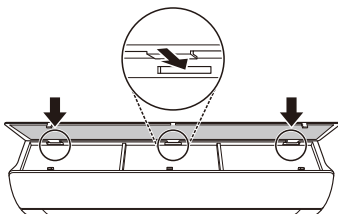

- 7 Push down hooks to assemble the air filter.

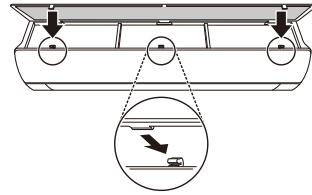

- 8 Check the side of the front cover for correct assembly of the air filter.

Type2

- 1 Turn off the power to the unit.
- 2 Open the front cover.
 - Lift up both sides of the cover slightly.
- 3 Hold the knobs of the air filters, pull them down slightly and remove them from the indoor unit.

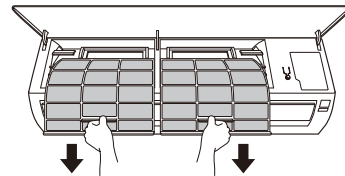

- 4 Clean the filters with a vacuum cleaner or with lukewarm water with neutral detergent.
- 5 Dry the filters in the shade.
- 6 Insert the hooks of the air filters into the front cover.

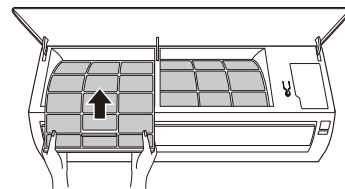

- 7 Check the side of the front cover for correct assembly of the air filters.

Clean the Micro Dust and Triple Filter (Optional)

- 1 Turn off the power to the unit.
- 2 Remove the air filters from the indoor unit.
- 3 Remove the Micro dust and Triple filter from the indoor unit.

Type1

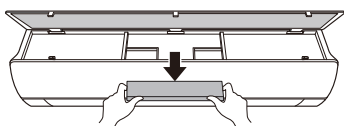

Type2

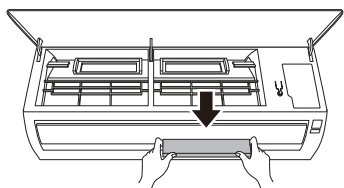

- 4 Clean the filter with a vacuum cleaner.

- 5 Insert the Micro dust and Triple filter.

Type1

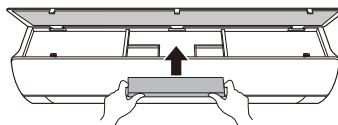

Type2

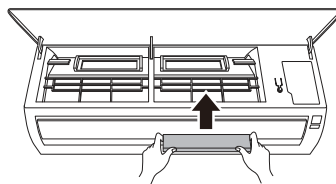

- 6 Assemble the air filters.
- 7 Check the side of the front cover for correct assembly of the air filters.

NOTE

- The feature and location of Micro dust and Triple filter may vary according to the type of model.

TROUBLESHOOTING

Self-diagnosis Function

This product has a built-in self-diagnosis function. If an error occurs, the lamp of the indoor unit will blink in 2 second intervals. If this occurs, contact your local dealer or service center.

Before Calling for Service

Please check the following before you contact the service center. If the problem persists, contact your local service center.

Symptoms	Possible Causes & Solution
The air conditioner does not work normally.	Burning smell and strange sounds are coming from the unit. <ul style="list-style-type: none"> Turn off the air conditioner, switch OFF, or disconnect the power supply, and contact the service center.
	Water leaks from the indoor unit even when the humidity level is low. <ul style="list-style-type: none"> Turn off the air conditioner, switch OFF, or disconnect the power supply, and contact the service center.
	The power cable is damaged or it is generating excessive heat. <ul style="list-style-type: none"> Turn off the air conditioner, switch OFF, or disconnect the power supply, and contact the service center.
	A switch, a circuit breaker (safety, ground), or a fuse is not operated properly. <ul style="list-style-type: none"> Turn off the air conditioner, switch OFF, or disconnect the power supply, and contact the service center.
	The unit generates an error code from its self-diagnosis. <ul style="list-style-type: none"> Turn off the air conditioner, switch OFF, or disconnect the power supply, and contact the service center.
The air conditioner does not work.	The air conditioner is unplugged. <ul style="list-style-type: none"> Check whether the power cord is plugged into the outlet or the power isolators are switched on.
	A fuse exploded, or the power supply is blocked. <ul style="list-style-type: none"> Replace the fuse or check if the circuit breaker has tripped.
	A power failure has occurred. <ul style="list-style-type: none"> Turn off the air conditioner when a power failure occurs. When the power is restored, wait 3 minutes, and then turn on the air conditioner.
	The voltage is too high or too low. <ul style="list-style-type: none"> Check if the circuit breaker has tripped.
	The air conditioner was turned off automatically at a preset time. <ul style="list-style-type: none"> Turn the air conditioner on.
	The battery setting in the remote controller is incorrect. <ul style="list-style-type: none"> Make sure that the batteries are inserted correctly in your remote controller. If the batteries are placed correctly, but the air conditioner still does not operate, replace the batteries and try again.

Symptoms	Possible Causes & Solution
The air conditioner does not emit cool air.	Air is not circulating properly. <ul style="list-style-type: none"> • Make sure that there are no curtains, blinds, or pieces of furniture blocking the front of the air conditioner.
	The air filter is dirty. <ul style="list-style-type: none"> • Clean the air filter once every 2 weeks. • See “Clean the Air Filter” for more information.
	The room temperature is too high. <ul style="list-style-type: none"> • In summer, cooling the indoor air fully may take some time. In this case, select the Jet Mode to cool the indoor air quickly.
	Cold air is escaping from the room. <ul style="list-style-type: none"> • Make sure that no cold air is escaping through the ventilation points in the room.
	The desired temperature is higher than the current temperature. <ul style="list-style-type: none"> • Set the desired temperature to a level lower than the current temperature.
	There is a heating source nearby. <ul style="list-style-type: none"> • Avoid using heat generators like electric ovens or gas burners while the air conditioner is in operation.
	Fan Mode is selected. <ul style="list-style-type: none"> • During Fan Mode, air blows from the air conditioner without cooling or heating the indoor air. • Switch the operation mode to cooling operation.
	Outside temperature is too high. <ul style="list-style-type: none"> • The cooling effect may not be sufficient.
The fan speed cannot be adjusted.	The Jet Mode, or Auto Operation Mode is selected. <ul style="list-style-type: none"> • In some operation modes, you cannot adjust the fan speed. Select an operation mode in which you can adjust the fan speed.
The temperature cannot be adjusted.	The Fan Mode or Jet Mode is selected. <ul style="list-style-type: none"> • In some operation modes, you cannot adjust the temperature. Select an operation mode in which you can adjust the temperature.
The air conditioner stops during operation.	The air conditioner is suddenly turned off. <ul style="list-style-type: none"> • The Timer Function may have timed out, which turns the unit off. Check the timer settings.
	A power failure has occurred during operation. <ul style="list-style-type: none"> • Wait for the power to come back. If you have the Auto Restart function enabled, your unit will resume its last operation several minutes after power is restored.

Symptoms	Possible Causes & Solution
The indoor unit is still operating even when the unit has been turned off.	<p>The Auto Clean function is being operated.</p> <ul style="list-style-type: none"> • Allow the Auto Clean function to continue since it removes any remaining moisture inside the indoor unit. If you do not want this feature, you can turn the unit off.
The air outlet on the indoor unit is discharging mist.	<p>The cooled air from the air conditioner makes mist.</p> <ul style="list-style-type: none"> • When the room temperature decreases, this phenomenon will disappear.
Water leaks from the outdoor unit.	<p>In the heating operations, condensed water drops from the heat exchanger.</p> <ul style="list-style-type: none"> • This symptom requires installing a drain hose under the base pan. Contact the installer.
There is noise or vibration.	<p>A clicking sound can be heard when the unit starts or stops due to movement of the reversing valve.</p> <p>Creaking sound: The plastic parts of the indoor unit creak when they shrink or expand due to sudden temperature changes.</p> <p>Flowing or Blowing sound: This is the flow of refrigerant through the air conditioner.</p> <ul style="list-style-type: none"> • These are normal symptoms. The noise will stop.
The indoor unit gives off an odor.	<p>Odors (such as cigarette smoke) may be absorbed into the indoor unit and discharged with airflow.</p> <ul style="list-style-type: none"> • If the smell does not disappear, you need to wash the filter. If this does not work, contact the service center to clean your heat exchanger.
The air conditioner does not emit warm air.	<p>When Heating Mode starts, the vane is almost closed, and no air comes out, even though the outdoor unit is operating.</p> <ul style="list-style-type: none"> • This symptom is normal. Please wait until the unit has generated enough warm air to blow through the indoor unit.
	<p>The outdoor unit is in Defrosting Mode.</p> <ul style="list-style-type: none"> • In Heating Mode, ice/frost is built up on the coils when the outside temperature falls. This function removes a layer of frost on the coil, and it should finish in approximately 15 minutes.
	<p>Outside temperature is too low.</p> <ul style="list-style-type: none"> • The heating effect may not be sufficient.

Symptoms	Possible Causes & Solution
Your home appliance and smartphone is not connected to the Wi-Fi network.	The password for the Wi-Fi that you are trying to connect to is incorrect. <ul style="list-style-type: none"> Find the Wi-Fi network connected to your smartphone and remove it, then register your appliance on LG ThinQ.
	Mobile data for your smartphone is turned on. <ul style="list-style-type: none"> Turn off the Mobile data of your smartphone and register the appliance using the Wi-Fi network.
	The wireless network name (SSID) is set incorrectly. <ul style="list-style-type: none"> The wireless network name (SSID) should be a combination of English letters and numbers. (Do not use special characters.)
	The router frequency is not 2.4 GHz. <ul style="list-style-type: none"> Only a 2.4 GHz router frequency is supported. Set the wireless router to 2.4 GHz and connect the appliance to the wireless router. To check the router frequency, check with your Internet service provider or the router manufacturer.
	The distance between the appliance and the router is too far. <ul style="list-style-type: none"> If the distance between the appliance and the router is too far, the signal may be weak and the connection may not be configured correctly. Move the location of the router so that it is closer to the appliance.

NOTE

- Some functions may not be supported, depending on the model.

WARRANTY (USA)

ARBITRATION NOTICE: THIS LIMITED WARRANTY CONTAINS AN ARBITRATION PROVISION THAT REQUIRES YOU AND LG TO RESOLVE DISPUTES BY BINDING ARBITRATION INSTEAD OF IN COURT, UNLESS YOU CHOOSE TO OPT OUT. IN ARBITRATION, CLASS ACTIONS AND JURY TRIALS ARE NOT PERMITTED. PLEASE SEE THE SECTION TITLED "PROCEDURE FOR RESOLVING DISPUTES" BELOW.

PROCEDURE FOR RESOLVING DISPUTES:

ALL DISPUTES BETWEEN YOU AND LG ARISING OUT OF OR RELATING IN ANY WAY TO THIS LIMITED WARRANTY OR THE PRODUCT SHALL BE RESOLVED EXCLUSIVELY THROUGH BINDING ARBITRATION, AND NOT IN A COURT OF GENERAL JURISDICTION. BINDING ARBITRATION MEANS THAT YOU AND LG ARE EACH WAIVING THE RIGHT TO A JURY TRIAL AND TO BRING OR PARTICIPATE IN A CLASS ACTION.

Definitions. For the purposes of this section, references to "LG" mean LG Electronics U.S.A., Inc., its parents, subsidiaries and affiliates, and each of their officers, directors, employees, agents, beneficiaries, predecessors in interest, successors, assigns and suppliers; references to "dispute" or "claim" shall include any dispute, claim or controversy of any kind whatsoever (whether based in contract, tort, statute, regulation, ordinance, fraud, misrepresentation or any other legal or equitable theory) arising out of or relating in any way to the sale, condition or performance of the product or this Limited Warranty.

Notice of Dispute. In the event you intend to commence an arbitration proceeding, you must first notify LG in writing at least 30 days in advance of initiating the arbitration by sending a letter to LG at LG Electronics, USA, Inc. Attn: Legal Department- Arbitration 111 Sylvan Avenue, Englewood Cliffs, NJ 07632. You and LG agree to engage in good faith discussions in an attempt to amicably resolve your claim. The notice must provide your name, address, and telephone number; identify the product that is the subject of the claim; and describe the nature of the claim and the relief being sought. If you and LG are unable to resolve the dispute within 30 days, either party may proceed to file a claim for arbitration.

Agreement to Binding Arbitration and Class Action Waiver. Upon failure to resolve the dispute during the 30 day period after sending written notice to LG, you and LG agree to resolve any claims between us only by binding arbitration on an individual basis, unless you opt out as provided below. Any dispute between you and LG shall not be combined or consolidated with a dispute involving any other person's or entity's product or claim. More specifically, without limitation of the foregoing, any dispute between you and LG shall not under any circumstances proceed as part of a class or representative action. Instead of arbitration, either party may bring an individual action in small claims court, but that small claims court action may not be brought on a class or representative basis.

Arbitration Rules and Procedures. To begin arbitration of a claim, either you or LG must make a written demand for arbitration. The arbitration will be administered by the American Arbitration Association ("AAA") and will be conducted before a single arbitrator under the AAA's Consumer Arbitration Rules that are in effect at the time the arbitration is initiated (referred to as the "AAA Rules") and under the procedures set forth in this section. The AAA Rules are available online at www.adr.org/consumer. Send a copy of your written demand for arbitration, as well as a copy of this provision, to the AAA in the manner described in the AAA Rules. You must also send a copy of your written demand to LG at LG Electronics, USA, Inc. Attn: Legal Department- Arbitration 111 Sylvan Avenue, Englewood Cliffs, NJ 07632. If there is a conflict between the AAA Rules and the rules set forth in this section, the rules set forth in this section will govern. This arbitration provision is governed by the Federal Arbitration Act. Judgment may be entered on the arbitrator's award in any court of competent jurisdiction. All issues are for the arbitrator to decide, except that issues relating to the scope and enforceability of the arbitration provision and to the arbitrability of the dispute are for the court to decide. The arbitrator is bound by the terms of this provision.

Governing Law. The law of the state of your residence shall govern this Limited Warranty and any disputes between us except to the extent that such law is preempted by or inconsistent with applicable federal law.

Fees/Costs. You do not need to pay any fee to begin an arbitration. Upon receipt of your written demand for arbitration, LG will promptly pay all arbitration filing fees to the AAA unless you seek more than \$25,000 in damages, in which case the payment of these fees will be governed by the AAA Rules. Except as otherwise provided for herein, LG will pay all AAA filing, administration and arbitrator fees for any arbitration initiated in accordance with the AAA Rules and this arbitration provision. If you prevail in the arbitration, LG will pay your attorneys' fees and expenses as long as they are reasonable, by considering factors including, but not limited to, the purchase amount and claim amount. Notwithstanding the foregoing, if applicable law allows for an award of reasonable attorneys' fees and expenses, an arbitrator can award them to the same extent that a court would. If the arbitrator finds either the substance of your claim or the relief sought in the demand is frivolous or brought for an improper purpose (as measured by the standards set forth in Federal Rule of Civil Procedure 11(b)), then the payment of all arbitration fees will be governed by the AAA Rules. In such a situation, you agree to reimburse LG for all monies previously disbursed by it that are otherwise your obligation to pay under the AAA Rules. Except as otherwise provided for, LG waives any rights it may have to seek attorneys' fees and expenses from you if LG prevails in the arbitration.

Hearings and Location. If your claim is for \$25,000 or less, you may choose to have the arbitration conducted solely on the basis of (1) documents submitted to the arbitrator, (2) through a telephonic hearing, or (3) by an in-person hearing as established by the AAA Rules. If your claim exceeds \$25,000, the right to a hearing will be determined by the AAA Rules. Any in-person arbitration hearings will be held at a location within the federal judicial district in which you reside unless we both agree to another location or we agree to a telephonic arbitration.

Opt Out. You may opt out of this dispute resolution procedure. If you opt out, neither you nor LG can require the other to participate in an arbitration proceeding. To opt out, you must send notice to LG no later than 30 calendar days from the date of the first consumer purchaser's purchase of the product by either: (i) sending an e-mail to optout@lge.com, with the subject line: "Arbitration Opt Out" or (ii) calling 1-800-980-2973. You must include in the opt out e-mail or provide by telephone: (a) your name and address; (b) the date on which the product was purchased; (c) the product model name or model number; and (d) the serial number (the serial number can be found (i) on the product; or (ii) online by accessing <https://www.lg.com/us/support/repair-service/schedule-repair-continued> and clicking on "Find My Model & Serial Number").

You may only opt out of the dispute resolution procedure in the manner described above (that is, by e-mail or telephone); no other form of notice will be effective to opt out of this dispute resolution procedure. Opting out of this dispute resolution procedure will not affect the coverage of the Limited Warranty in any way, and you will continue to enjoy the full benefits of the Limited Warranty. If you keep this product and do not opt out, then you accept all terms and conditions of the arbitration provision described above.

WARRANTY (CANADA)

ARBITRATION NOTICE: THIS LIMITED WARRANTY CONTAINS AN ARBITRATION PROVISION THAT REQUIRES YOU AND LG TO RESOLVE DISPUTES BY BINDING ARBITRATION INSTEAD OF IN COURT, UNLESS THE LAWS OF YOUR PROVINCE OR TERRITORY DO NOT PERMIT THAT, OR, IN OTHER JURISDICTIONS, IF YOU CHOOSE TO OPT OUT. IN ARBITRATION, CLASS ACTIONS AND JURY TRIALS ARE NOT PERMITTED. PLEASE SEE THE SECTION TITLED “PROCEDURE FOR RESOLVING DISPUTES” BELOW.

PROCEDURE FOR RESOLVING DISPUTES:

EXCEPT WHERE PROHIBITED AT LAW, ALL DISPUTES BETWEEN YOU AND LG ARISING OUT OF OR RELATING IN ANY WAY TO THIS LIMITED WARRANTY OR THE PRODUCT SHALL BE RESOLVED EXCLUSIVELY THROUGH BINDING ARBITRATION, AND NOT IN A COURT OF GENERAL JURISDICTION. EXCEPT WHERE PROHIBITED AT LAW, YOU AND LG BOTH IRREVOCABLY AGREE TO WAIVE THE RIGHT TO A JURY TRIAL AND TO BRING OR PARTICIPATE IN A CLASS ACTION.

Definitions. For the purposes of this section, references to “LG” mean LG Electronics Canada, Inc., its parents, subsidiaries and affiliates, and each of their officers, directors, employees, agents, beneficiaries, predecessors in interest, successors, assigns and suppliers; references to “dispute” or “claim” shall include any dispute, claim or controversy of any kind whatsoever (whether based in contract, tort, statute, regulation, ordinance, fraud, misrepresentation or any other legal or equitable theory) arising out of or relating in any way to the sale, condition or performance of the product or this Limited Warranty.

Notice of Dispute. In the event you intend to commence an arbitration proceeding, you must first notify LG in writing at least 30 days in advance of initiating the arbitration by sending a letter to LGECI Legal Team at 20 Norelco Drive, North York, Ontario, Canada M9L 2X6 (the “Notice of Dispute”). You and LG agree to engage in good faith discussions in an attempt to amicably resolve your claim. The notice must provide your name, address, and telephone number; identify the product that is the subject of the claim; and describe the nature of the claim and the relief being sought. If you and LG are unable to resolve the dispute within 30 days of LG’s receipt of the Notice of Dispute, the dispute shall be resolved by binding arbitration in accordance with the procedure set out herein. You and LG both agree that, during the arbitration proceeding, the terms (including any amount) of any settlement offer made by either you or LG will not be disclosed to the arbitrator until the arbitrator determines the dispute.

Agreement to Binding Arbitration and Class Action Waiver. Upon failure to resolve the dispute during the 30 day period after LG’s receipt of the Notice of Dispute, you and LG agree to resolve any claims between you and LG only by binding arbitration on an individual basis, unless you opt out as provided below, or you reside in a jurisdiction that prevents full application of this clause in the circumstances of the claims at issue (in which case if you are a consumer, this clause will only apply if you expressly agree to the arbitration). To the extent permitted by applicable law, any dispute between you and LG shall not be combined or consolidated with a dispute involving any other person’s or entity’s product or claim. More specifically, without limitation of the foregoing, except to the extent such a prohibition is not permitted at law, any dispute between you and LG shall not under any circumstances proceed as part of a class or representative action. Instead of arbitration, either party may bring an individual action in small claims court, but that small claims court action may not be brought on a class or representative basis except to the extent this prohibition is not permitted at law in your province or territory of jurisdiction as it relates to the claims at issue between you and LG.

Arbitration Rules and Procedures. To begin arbitration of a claim, either you or LG must make a written demand for arbitration. The arbitration will be private and confidential, and conducted on a simplified and expedited basis before a single arbitrator chosen by the parties under the provincial or territorial commercial arbitration law and rules of the province or territory of your residence. You must also send a copy of your written demand to LG at LG Electronics, Canada, Inc., Attn: Legal Department- Arbitration, 20 Norelco Drive, North York, Ontario M9L 2X6. This arbitration provision is governed by your applicable provincial or territorial commercial arbitration legislation. Judgment may be entered on the arbitrator’s award in any court of competent jurisdiction. All issues are for the arbitrator to decide, except that, issues relating to the scope and enforceability of the arbitration provision and to the arbitrability of the dispute are for the court to decide. The arbitrator is bound by the terms of this provision.

Governing Law. The law of the province or territory of your purchase shall govern this Limited Warranty and any disputes between you and LG except to the extent that such law is preempted by or inconsistent with applicable federal or provincial/territorial law. Should arbitration not be permitted for any claim, action, dispute or controversy between you and LG, you and LG attorn to the exclusive jurisdiction of the courts of the province or territory of your purchase for the resolution of the claim, action, dispute or controversy between you and LG.

Fees/Costs. You do not need to pay any fee to begin an arbitration. Upon receipt of your written demand for arbitration, LG will promptly pay all arbitration filing fees unless you seek more than \$25,000 in damages, in which case the payment of these fees will be governed by the applicable arbitration rules. Except as otherwise provided for herein, LG will pay all filing, administration and arbitrator fees for any arbitration initiated in accordance with the applicable arbitration rules and this arbitration provision. If you prevail in the arbitration, LG will pay your attorneys' fees and expenses as long as they are reasonable, by considering factors including, but not limited to, the purchase amount and claim amount. Notwithstanding the foregoing, if applicable law allows for an award of reasonable attorneys' fees and expenses, an arbitrator can award them to the same extent that a court would. If the arbitrator finds either the substance of your claim or the relief sought in the demand is frivolous or brought for an improper purpose (as measured by the applicable laws), then the payment of all arbitration fees will be governed by the applicable arbitration rules. In such a situation, you agree to reimburse LG for all monies previously disbursed by it that are otherwise your obligation to pay under the applicable arbitration rules. Except as otherwise provided for, LG waives any rights it may have to seek attorneys' fees and expenses from you if LG prevails in the arbitration.

Hearings and Location. If your claim is for \$25,000 or less, you may choose to have the arbitration conducted solely (1) on the basis of documents submitted to the arbitrator, (2) through a telephonic hearing, or (3) by an in-person hearing as established by the applicable arbitration rules. If your claim exceeds \$25,000, the right to a hearing will be determined by the applicable arbitration rules. Any in-person arbitration hearings will be held at the nearest, most mutually-convenient arbitration location available within the province or territory in which you reside unless you and LG both agree to another location or agree to a telephonic arbitration.

Severability and Waiver. If any portion of this Limited Warranty (including these arbitration procedures) is unenforceable, the remaining provisions will continue in full force and effect to the maximum extent permitted by applicable law. Should LG fail to enforce strict performance of any provision of this Limited Warranty (including these arbitration procedures), it does not mean that LG intends to waive or has waived any provision or part of this Limited Warranty.

Opt Out. You may opt out of this dispute resolution procedure. If you opt out, neither you nor LG can require the other to participate in an arbitration proceeding. To opt out, you must send notice to LG no later than 30 calendar days from the date of the first consumer purchaser's purchase of the product by either (i) sending an e-mail to optout@lge.com, with the subject line: "Arbitration Opt Out;" or (ii) calling 1-800-980-2973. You must include in the opt out e-mail or provide by telephone: (a) your name and address; (b) the date on which the product was purchased; (c) the product model name or model number; and (d) the serial number (the serial number can be found (i) on the product; or (ii) online by accessing https://www.lg.com/ca_en/support/repair-service/schedule-repair and clicking on "Find My Model & Serial Number").

In the event that you "Opt Out", the law of the province or territory of your residence shall govern this Limited Warranty and any disputes between you and LG except to the extent that such law is preempted by or inconsistent with applicable federal or provincial/territorial law. Should arbitration not be permitted for any claim, action, dispute or controversy between you and LG, you and LG agree to attorn to the exclusive jurisdiction of the courts of the province or territory of your residence for the resolution of the claim, action, dispute or controversy between you and LG.

You may only opt out of the dispute resolution procedure in the manner described above (that is, by e-mail or telephone); no other form of notice will be effective to opt out of this dispute resolution procedure. Opting out of this dispute resolution procedure will not affect the coverage of the Limited Warranty in any way, and you will continue to enjoy the full benefits of the Limited Warranty. If you keep this product and do not opt out, then you accept all terms and conditions of the arbitration provision described above.

Conflict of Terms. In the event of a conflict or inconsistency between the terms of this Limited Warranty and the End User License Agreement ("EULA") in regards to dispute resolution, the terms of this Limited Warranty shall control and govern the rights and obligations of the parties and shall take precedence over the EULA.



US	Please call the installing contractor of your product, as warranty service will be provided by them.
CANADA	Service call Number # : (888) LG Canada, (888) 542-2623 Numéro pour les appels de service : LG Canada, 1-888-542-2623



OWNER'S MANUAL

AIR CONDITIONER

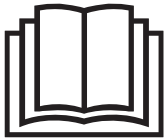

Read this owner's manual thoroughly before operating the appliance and keep it handy for reference at all times.

TYPE: WALL MOUNTED

ENGLISH



ENERGY STAR

If Indoor unit are connected with multi split type, It is not Energy Star certified products



MFL69491102
Rev.12_020521

www.lg.com

Copyright © 2017 - 2021 LG Electronics Inc. All Rights Reserved

TABLE OF CONTENTS

2 TABLE OF CONTENTS

3 SAFETY INSTRUCTIONS

3 IMPORTANT SAFETY INSTRUCTIONS

7 OPERATION

7 Notes for Operation
7 Parts and Functions
8 Wireless Remote Control
13 Restarting the Air Conditioner Automatically
13 Using the Mode Function
15 Using the Jet Mode Function
16 Using the Fan Speed Function
16 Using the Air Flow Direction Function
17 Setting the On/Off Timer
18 Using the Sleep Function (Optional)
18 Using the Simple Timer Function (Optional)
19 Using the Energy Display Function (Optional)
19 Using the Light Off Function (Optional)
19 Using the Comfort Air Function (Optional)
20 Using the Energy Saving Function (Optional)
20 Using the Energy Control Function (Optional)
21 Using Special Functions

24 SMART FUNCTIONS

24 LG ThinQ Application
26 Smart Diagnosis™

27 MAINTENANCE

29 Clean the Air Filter
30 Clean the Micro Dust and Triple Filter (Optional)

31 TROUBLESHOOTING

35 WARRANTY (USA)

37 WARRANTY (CANADA)

SAFETY INSTRUCTIONS

READ ALL INSTRUCTIONS BEFORE USE

Your safety and the safety of others are very important.

We have provided many important safety messages in this manual and on your appliance. Always read and follow all safety messages.

 This is the safety alert symbol.

This symbol alerts you to potential hazards that can kill or injure you and others.

All safety messages will follow the safety alert symbol and either the word **WARNING**, or **CAUTION**.

WARNING

If you do not follow instructions, it could result in death or serious injury.

CAUTION

If you do not follow instructions, it could result in minor or moderate injury or damage to the product.

All safety messages will tell you what the potential hazard is, tell you how to reduce the chance of injury, and tell you what may happen if the instructions are not followed.

IMPORTANT SAFETY INSTRUCTIONS

WARNING

To reduce the risk of explosion, fire, death, electric shock, injury or scalding to persons when using this product, follow basic precautions, including the following:

- Installation or repairs made by unauthorized persons can pose hazards to you and others.
- Installation **MUST** conform to the local building codes or, in the absence of local codes, the National Electrical Code NFPA 70/ANSI C1-1003 or current edition and Canadian Electrical Code Part1 CSA C.22. 1.
- The information contained in the manual is intended for use by a qualified service technician who is familiar with the safety procedures and equipped with the proper tools and test instruments.
- Failure to read and follow all instructions in this manual can result in equipment malfunction, property damage, personal injury and/or death.
- When the power cord is to be replaced, the replacement work shall be performed by authorized personnel using only genuine replacement parts.
- This appliance is not intended for use by persons (including children) with reduced physical, sensory or mental capabilities, or lack of experience and knowledge, unless they have been given supervision or instruction concerning use of the appliance by a person responsible for their safety. Children should be supervised to ensure that they do not play with the appliance.

Installation

- Do not install the air conditioner on an unstable surface or in a place where there is danger of it falling.
- Contact an authorized service center when installing or relocating the air conditioner.
- Install the panel and the cover of the control box safely.
- Do not install the air conditioner in a place where flammable liquids or gases such as gasoline, propane, paint thinner, etc., are stored.
- Make sure that the pipe and the power cable connecting the indoor and outdoor units are not pulled too tight when installing the air conditioner.
- Use standard circuit breaker and fuse that conform to the rating of the air conditioner.
- Do not input air or gas into the system except with the specific refrigerant.
- Use non-flammable gas (nitrogen) to check for leak and to purge air; using compressed air or flammable gas may cause fire or explosion.
- The indoor/outdoor wiring connections must be secured tightly, and the cable should be routed properly so that there is no force pulling the cable from the connection terminals. Improper or loose connections can cause heat generation or fire.
- Install dedicated electric outlet and circuit breaker before using the air conditioner.
- Do not connect the ground wire to a gas pipe, a lightning rod, or a telephone ground wire.
- If the supply cord is damaged, it must be replaced by the manufacturer, its service agent or similarly qualified person in order to avoid a hazard.
- Do not install the unit in potentially explosive atmospheres.

Operation

- Be sure to use only those parts listed in the service parts list. Never attempt to modify the equipment.
- Make sure that children do not climb on or hit the outdoor unit.
- Dispose of the batteries in a place where there is no danger of fire.
- Use only the refrigerant specified on the air conditioner label.
- Cut off the power supply if there is any noise, smell, or smoke coming from the air conditioner.
- Do not leave flammable substances such as gasoline, benzene, or thinner near the air conditioner.
- Contact an authorized service center when the air conditioner is submerged by flood waters.
- Do not use the air conditioner for an extended period of time in a small place without proper ventilation.
- In the event of a gas leak (such as Freon, propane gas, LP gas, etc.) ventilate sufficiently before using the air conditioner again.
- To clean the interior, contact an authorized service center or dealer. Using harsh detergents may cause corrosion or damage to the unit.

- Be sure to ventilate sufficiently when the air conditioner and a heating appliance such as a heater are used simultaneously.
- Do not block the inlet or outlet of air flow.
- Do not insert hands or other objects through the air inlet or outlet while the air conditioner is operating.
- Make sure that the power cable is neither dirty, loose, nor broken.
- Never touch, operate, or repair the air conditioner with wet hands.
- Do not place any objects on the power cable.
- Do not place a heater or other heating appliances near the power cable.
- Do not modify or extend the power cable. Scratches or peeling insulation on the power cables may result in fire or electric shock, and should be replaced.
- Cut off the power supply immediately in the event of a blackout or a thunderstorm.
- Take care to ensure that power cable could not be pulled out or damaged during operation.
- Do not touch refrigerant pipe, water pipe and any internal parts while the unit is operating or immediately after operation.

Maintenance

- Do not clean the appliance by spraying water directly onto the product.
- Before cleaning or performing maintenance, disconnect the power supply and wait until the fan stops.

CAUTION

To reduce the risk of minor injury to persons, malfunction, or damage to the product or property when using this product, follow basic precautions, including the following:

Installation

- Do not install the air conditioner in an area where it is directly exposed to sea wind (salt spray).
- Install the drain hose properly for the smooth drainage of water condensation.
- Exercise caution when unpacking or installing the air conditioner.
- Do not touch the leaking refrigerant during installation or repair.
- Transport the air conditioner with two or more people or use a forklift.
- Install the outdoor unit such that it is protected from direct sunlight. Do not place the indoor unit in a place where it is directly exposed to sunlight via the windows.
- Safely dispose of packing materials such as screws, nails, plastic bag or batteries using proper packaging after installation or repair.
- Install the air conditioner in a place where the noise from the outdoor unit or the exhaust fumes will not inconvenience the neighbors. Failure to do so may result in conflict with the neighbors.

Operation

- Remove the batteries if the remote control is not to be used for an extended period of time.
- Make sure that the filter is installed before operating the air conditioner.
- Be sure to check if there is a refrigerant leak after installing or repairing the air conditioner.
- Follow the standards of the corresponding region or country for handling the refrigerant and the air conditioner and for disassembling the air conditioner.
- Do not place any object on the air conditioner.
- Never mix different types of batteries, or old and new batteries for the remote control.
- Do not let the air conditioner run for a long time when humidity is very high or when a door or a window has been left open.
- Stop using the remote control if there is a fluid leak in the battery. If your clothes or skin are exposed to the leaking battery fluid, wash off with clean water.
- Do not expose people, animals, or plants to the cold or hot wind from the air conditioner for extended periods of time.
- If the leaking battery fluid has been swallowed, rinse the inside of the mouth thoroughly and consult a doctor.
- Do not drink the water drained from the air conditioner.
- Do not use the product for special purposes, such as preserving foods, works of art, and etc. It is an air conditioner for consumer purposes, not a precision refrigeration system. There is risk of damage or loss of property.
- Do not recharge or disassemble the batteries.

Maintenance

- Never touch the metal parts of the air conditioner when removing the air filter.
- Use a sturdy stool or ladder when cleaning, maintaining, or repairing the air conditioner at a height.
- Never use strong cleaning agents or solvents when cleaning the air conditioner or spray water. Use a smooth cloth.

OPERATION

Notes for Operation

Suggestion for Energy Saving

- Do not over-cool the space. This may be harmful for your health and may consume more electricity.
- Block sunlight with blinds or curtains while you are operating the air conditioner.
- Keep doors or windows closed tightly while you are operating the air conditioner.
- Adjust the direction of the air flow vertically or horizontally to circulate indoor air.
- Speed up the fan to cool or warm indoor air quickly, within a short period of time.
- Open windows regularly for ventilation. The indoor air quality may deteriorate if the air conditioner is used for long durations.
- Clean the air filter once every 2 weeks. Dust and impurities collected in the air filter may block the air flow or reduce the unit performance.

Parts and Functions

Indoor Unit

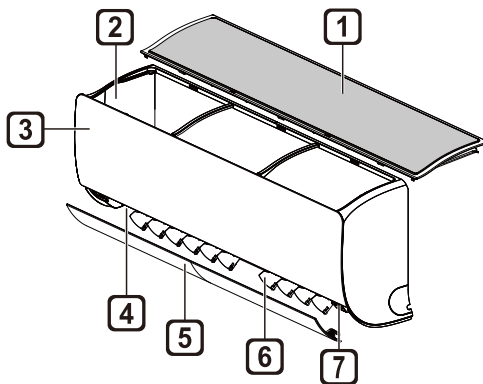

- 1 Air Filter
- 2 Air Intake
- 3 Front Cover
- 4 Air Outlet
- 5 Air Deflector (Horizontal Vane)
- 6 Air Deflector (Vertical Louver)
- 7 On/Off Button

Outdoor Unit

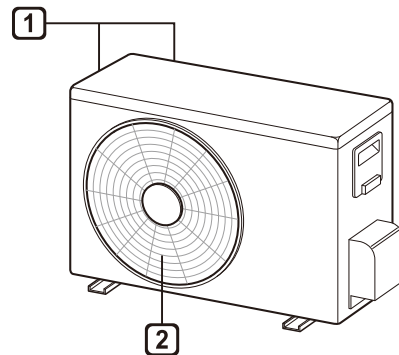

- 1 Air Intake Vents
- 2 Air Outlet Vents

NOTE

- The number and location of operation lamps may vary according to the model of the air conditioner.
- The feature may be changed according to the type of model.

Wireless Remote Control

Inserting Batteries

If the display screen of the remote control begins to fade, replace the batteries. Insert AAA (1.5 V) batteries before using the remote control.

- 1 Remove the battery cover.

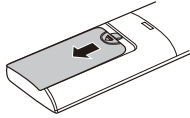

- 2 Insert the new batteries and make sure that the + and - terminals of the batteries are installed correctly.

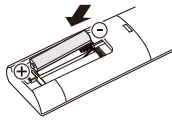

Installing the Remote Control Holder

To protect the remote control, install the holder where there is no direct sunlight.

- 1 Choose a safe and easily accessible location.
- 2 Fix the holder by fastening 2 screws firmly with a screwdriver.

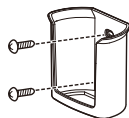

Operating Method

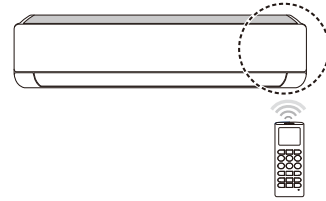

Point the remote control towards the signal receiver at the right side of the air conditioner to operate it.



NOTE

- The remote control may operate other electronic devices if it is directed towards them. Make sure to point the remote control towards the air conditioner signal receiver.
- For proper operation, use a soft cloth to clean the signal transmitter and receiver.
- In case of a function not provided in the product, no buzzer sound occurs from the product when a button for such function on the remote control is pressed except for Air Flow Direction (SWING), Energy Display (kW_[3-5]), Air Purification function ().

Setting the Current Time

- 1 Insert batteries.
 - The icon below blinks at the bottom of the display screen.
- 
- 2 Press  or  button to select the minutes.
 - 3 Press **SET/CANCEL** button to finish.

NOTE

- The On/Off Timer is available after setting the current time.

Using the °C/°F Conversion Function (Optional)

This function changes unit between °C and °F

- Press and hold  button about 5 seconds.

Operating the Air Conditioner without the Remote Control

You can use the **ON/OFF** button of the indoor unit to operate the air conditioner when the remote control is unavailable.

- 1 Open the front cover (Type2) or horizontal vane (Type1).
- 2 Press the **ON/OFF** button.

Type1

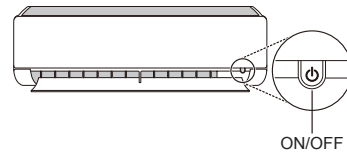

Type2

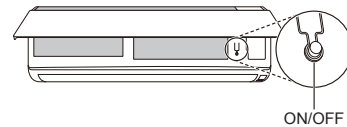

NOTE

- The stepping motor may be broken, if the horizontal vane opens rapidly.
- The fan speed is set to high.
- The feature may be changed according to the type of model.
- The temperature cannot be altered when using this emergency **ON/OFF** button.
- For cooling & heating models, the temperature is set from 22 °C to 24 °C

Using Wireless Remote Control

You can operate the air conditioner more conveniently with the remote control.

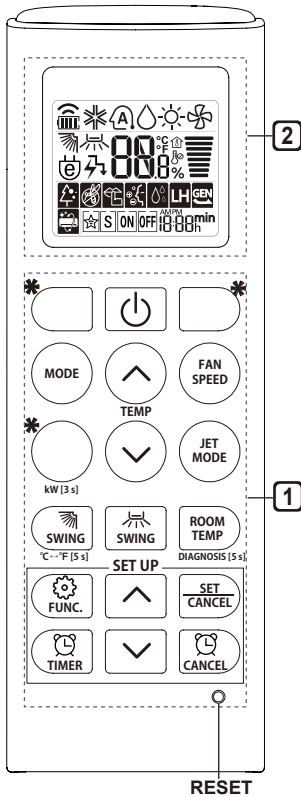

1 Button	2 Display Screen	Description	Available Function	
			Single Split	Multi
	-	To turn on/off the air conditioner.	○	○
	88°C	To adjust the desired room temperature in cooling, heating or auto changeover mode.	○	○
MODE		To select the cooling mode.	○	○
		To select the heating mode.	○	○
		To select the dehumidification mode.	○	○
		To select the fan mode.	○	○
		To select the auto changeover/auto operation mode.	○	○
JET MODE	Po	To change room temperature quickly.	○	○
FAN SPEED		To adjust the fan speed.	○	○
		To adjust the air flow direction vertically or horizontally.	○	○

NOTE



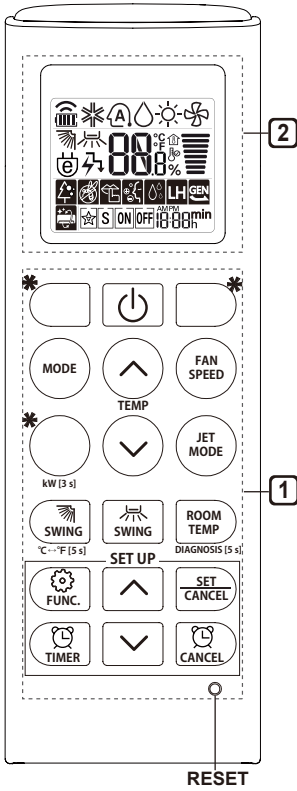



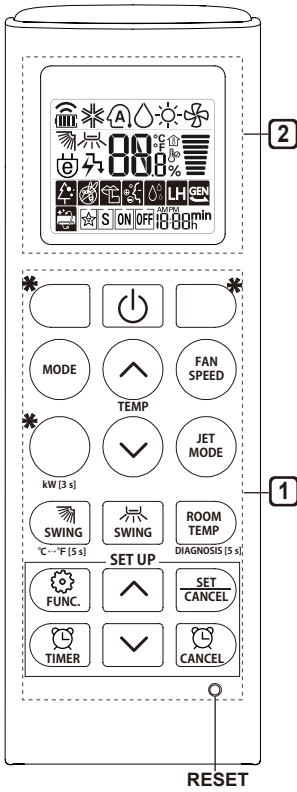

- * buttons may be changed according to the type of model.
- When connected to the Multi Outdoor unit, the Energy Display, Energy Control, Silent and Smart Diagnosis function may not be supported.



1 Button	2 Display Screen	Description	Available Function	
			Single Split	Multi
	S 	To turn on/off air conditioner automatically at desired time.	○	○
SET/ CANCEL	-	To set/cancel the special functions and timer.	○	○
	-	To cancel the timer settings.	○	○
	-	To adjust time.	○	○
*LIGHT OFF	-	To set the brightness of the display on the indoor unit.	○	○
ROOM TEMP		To display the room temperature.	○	○
°C↔°F [5 s]		To change unit between °C and °F	○	○
*ENERGY SAVING		To minimize power consumption.	○	○
*COMFORT AIR		To adjust the air flow to deflect wind.	○	○
kW [3 s]	-	To set whether or not to display information regarding energy.	○	X
*ENERGY CTRL	00 %	To bring the effect of the power saving.	X	X
*COMFORT SLEEP		To make a comfortable sleeping environment.	○	X
DIAGNOSIS [5 s]	-	To conveniently check maintenance information of a product.	○	○

RESET



1 Button	2 Display Screen	Description	Available Function	
			Single Split	Multi
		The Ion generator uses millions of ions to help improve indoor air quality.	X	X
		To reduce noise from outdoor units.	X	X
		To keep your skin moisturized by generating ion clusters.	X	X
		To lower indoor humidity quickly.	X	X
		To maintain a minimum room temperature and prevent objects in the room from freezing.	○ (Optional)	X
		To scare away a mosquito.	X	X
		To remove moisture generated inside the indoor unit.	○	○
		To make a comfortable sleeping environment.	X	X
RESET	-	To initialize the remote control settings.	○	○

NOTE

- Some functions may not be supported, depending on the model.
- * buttons may be changed according to the type of model.
- Press the **SET/CANCEL** button to operate the selected **FUNC.**

Restarting the Air Conditioner Automatically

When the air conditioner is turned on again after a power failure, this function restores the previous settings.

Disabling Auto Restart

- 1 Open the front cover (Type2) or horizontal vane (Type1).
- 2 Press the **ON/OFF** button and hold it for 6 seconds, then the unit will beep twice and the lamp will blink twice 4 times.
 - To re-enable the function, press the **ON/OFF** button and hold it for 6 seconds. The unit will beep twice and the lamp will blink 4 times.

Type1

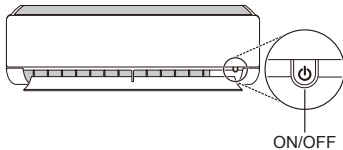

Type2

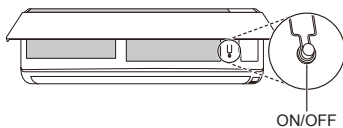

NOTE

- The feature may be changed according to the type of model.
- If you press and hold the **ON/OFF** button for 3 – 5 seconds, instead of 6 seconds, the unit will switch to the test operation. In the test operation, the unit blows out strong cooling air for 18 minutes and then returns to factory default settings.

Using the Mode Function

This function allows you to select the desired function.

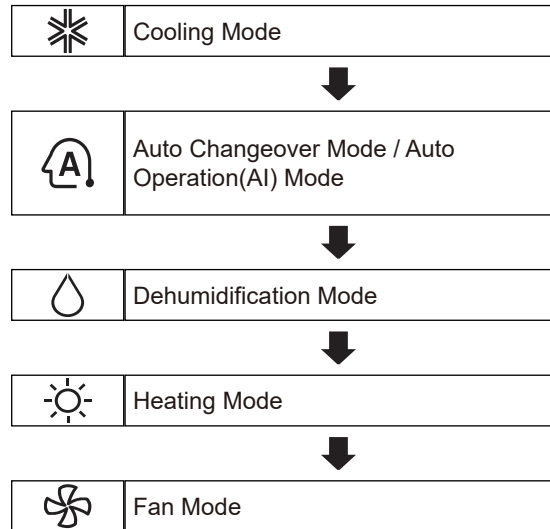



Cooling Mode

- 1 Turn the appliance on.
- 2 Press **MODE** button repeatedly to select the Cooling Mode.
 - ❄️ is displayed on the display screen.
- 3 Press or button to set the desired temperature.

Auto Operation (Artificial Intelligence)

Multi Model



In this operation mode, the system is automatically operated by the electronic controls.

- 1 Turn the appliance on.
- 2 Press **MODE** button repeatedly to select the Auto Operation.
 -  is displayed on the display screen.
- 3 Press  or  button to set the desired temperature.
- 4 Press **FAN SPEED** button to adjust the fan speed.

Auto Changeover Mode

Single Split Model

This mode changes the mode automatically to maintain the set temperature at ± 2 °C

- 1 Turn the appliance on.
- 2 Press **MODE** button repeatedly to select the Auto Changeover Mode.
 -  is displayed on the display screen.
- 3 Press  or  button to set the desired temperature.
- 4 Press **FAN SPEED** button to adjust the fan speed.

Dehumidification Mode



This mode removes excess moisture from a highly humid environment or during the rainy season, in order to prevent mildew from setting in. This mode adjusts the room temperature and the fan speed automatically to maintain the optimal level of humidity.

- 1 Turn the appliance on.
- 2 Press **MODE** button repeatedly to select the Dehumidification Mode.
 -  is displayed on the display screen.

NOTE

- In this mode you cannot adjust the room temperature, it is adjusted automatically.
- The room temperature is not displayed on the display screen.
- In the dehumidification mode, compressor and indoor fan may not operate when the room temperature is below 24 °C

Heating Mode

- 1 Turn the appliance on.
- 2 Press **MODE** button repeatedly to select the Heating Mode.
 -  is displayed on the display screen.
- 3 Press  or  button to set the desired temperature.

NOTE

-  will be displayed on the indoor unit when defrosting is operating.
- Furthermore, this indication will be displayed on the indoor unit:
 - When preheating is operating.
 - When the room temperature has been reached to the set temperature.

Fan Mode

This mode only circulates the indoor air without changing the room temperature.

- 1 Turn the appliance on.
- 2 Press **MODE** button repeatedly to select the Fan Mode.
 -  is displayed on the display screen.
- 3 Press **FAN SPEED** button to adjust the fan speed.

Using the Jet Mode Function





Changing Room Temperature Quickly

This function allows you to cool indoor air quickly during the summer or warm it quickly during winter.

- The Jet Mode function is available with Cooling, Heating and Dehumidification Mode.

- 1 Turn the appliance on.
- 2 Press **MODE** button repeatedly to select the desired mode.
- 3 Press **JET MODE** button.
 -  is displayed on the display screen.

NOTE

- Jet Heating Mode is not available on some models.
- In Jet Cooling Mode, strong air blows out for 30 minutes.
 - After 30 minutes later, setting temperature is maintaining 18 °C
If you want to change the temperature, Press  or  button to set the desired temperature.
- In Jet Heating Mode, strong air blows out for 30 minutes.
 - After 30 minutes later, setting temperature is maintaining 30 °C
If you want to change the temperature, Press  or  button to set the desired temperature.
- This function may operate differently from the remote control display.

Using the Fan Speed Function

Adjusting the Fan Speed

- Press **FAN SPEED** button repeatedly to adjust the fan speed.

Display Screen	Speed
	High
	Medium - High
	Medium
	Medium - Low
	Low
-	Natural Wind

NOTE

- The fan speed of Natural Wind adjusts automatically.



- The fan speed icons are displayed on some indoor units.

F1 → F2 → F3 → F4 → F5

- Indoor unit display is displayed only 5 seconds and return to the setting temperature on some models.

Using the Air Flow Direction Function

This function adjusts the direction of the air flow vertically (horizontally).

- Press button repeatedly and select the desired direction.
 - Select to adjust the direction of the air flow automatically.

NOTE

- Adjusting the air flow direction horizontally may not be supported, depending on the model.
- Adjusting the air deflector arbitrarily may cause product failure.
- If you restart the air conditioner, it starts to operate with the previously set direction of air flow, so the air deflector may not match the icon displayed on the remote control. When this occurs, press or button to adjust the direction of the air flow again.
- This function may operate differently from the remote control display.

Setting the On/Off Timer



This function sets the air conditioner to turn on/off automatically at desired time.

On/Off Timer can be set together.

Setting the On Timer

- 1 Press  button repeatedly.
 - The icon below blinks at the bottom of the display screen.



- 2 Press  or  button to select the minutes.
- 3 Press **SET/CANCEL** button to finish.
 - After setting the timer, current time and  icon are displayed on the display screen indicating that the desired time is set.

Canceling the On Timer

- 1 Press  button repeatedly.
 - The icon below blinks at the bottom of the display screen.





- 2 Press **SET/CANCEL** button to cancel the setting.

Setting the Off Timer

- 1 Press  button repeatedly.
 - The icon below blinks at the bottom of the display screen.



- 2 Press  or  button to select the minutes.
- 3 Press **SET/CANCEL** button to finish.
 - After setting the timer, current time and  icon are displayed on the display screen indicating that the desired time is set.

NOTE

- This function is disabled when you set Simple Timer.

Canceling the Off Timer

- 1 Press  button repeatedly.
 - The icon below blinks at the bottom of the display screen.



- 2 Press **SET/CANCEL** button to cancel the setting.

Canceling the Timer Setting



- Press  button to cancel all timer settings.

Using the Sleep Function (Optional)

This function turns off the air conditioner automatically when you go to sleep.

- 1 Turn the appliance on.
- 2 Press  button repeatedly.
 - The icon below blinks at the bottom of the display screen.



- 3 Press  or  button to select the hour (up to 7 hours).
- 4 Press **SET/CANCEL** button to finish.
 -  is displayed on the display screen.

NOTE



-  is displayed on some indoor units.
- Indoor unit display is displayed from 1H to 7H which is displayed only 5 seconds and then return to the setting temperature.
- In the Cooling and Dehumidification Mode, the temperature increases by 1 °C after 30 minutes and additional 1 °C after another 30 minutes for a more comfortable sleep.
- The temperature increases up to 2 °C from the preset temperature.
- Although the remark for fan speed on the display screen may be changed, the fan speed is adjusted automatically.

Using the Simple Timer Function (Optional)

This function turns off the air conditioner automatically when you go to sleep.

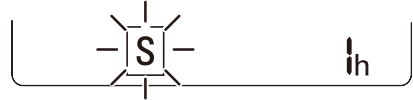
- 1 Turn the appliance on.
- 2 Press  button repeatedly.
 - The icon below blinks at the bottom of the display screen.



- 3 Press  or  button to select the hour (up to 7 hours).
- 4 Press **SET/CANCEL** button to finish.
 -  is displayed on the display screen.



NOTE

- This function is disabled when you set Off Timer.

Using the Energy Display Function (Optional)

This function displays the amount of electricity generated on the indoor display as the product operates.

Display the Current Energy Usage

- 1 Turn the appliance on.
- 2 Press  button and hold it about 3 seconds.
 - The instantaneous power consumption () is displayed for a while on some indoor units.

NOTE

- It is not displayed on the wireless remote control.
- The unit of the displayed value is kW.
- If it is more than 99 kW, which is the range of expression, maintain it as 99 kW.
- Display wattage under 10 kW with 0.1 kW unit, and display one over 10 kW with 1 kW unit.
- The actual power may differ from the power displayed.
- When connected to the Multi Outdoor unit, this function may not be supported.

Using the Light Off Function (Optional)

Display Screen Brightness

You can set the brightness of the indoor unit display screen.

- Press **LIGHT OFF** button.



NOTE

- Turn on/off the Display screen.



Using the Comfort Air Function (Optional)

Comfort Vane Operation

This function conveniently sets the vane to a preset position to deflect the supply air away from blowing directly onto the occupants in the room.

- 1 Turn the appliance on.
- 2 Press **COMFORT AIR** button repeatedly and select the desired direction.
 -  or  is displayed on the display screen.

NOTE

-  or  is displayed on some indoor units.
- This function is disabled when you press **MODE** or **JET MODE** button.
- This function is disabled and auto swing of vertical direction is set up when you press  button.
- When this function is off, the horizontal vane operates automatically depending on the set mode.

Using the Energy Saving Function (Optional)







This function minimizes power consumption during Cooling and increases the set temperature to the optimal level for a more comfortable environment. The temperature automatically settles at 22 °C if desired temperature is below 22 °C. The temperature remains constant if it is above 22 °C.

- 1 Turn the appliance on.
- 2 Press **MODE** button repeatedly to select the Cooling Mode.
- 3 Press **ENERGY SAVING** button.
 -  is displayed on the display screen.

Using the Energy Control Function (Optional)

- 1 Turn the appliance on.
- 2 Press **ENERGY CTRL** button.
 - Press **ENERGY CTRL** button repeatedly to select each step.

NOTE

- 1 step : The power Input is decreased by 20 % compared to rated power input.
 -  % is displayed on the display screen.
- 2 step : The power Input is decreased by 40 % compared to rated power input.
 -  % is displayed on the display screen.
- 3 step (Optional) : The power Input is decreased by 60 % compared to rated power input.
 -  % is displayed on the display screen.
-  (1 step),  (2 step) is displayed on some indoor units.
- This function is available with Cooling Mode.
- Capacity may decrease when Energy Control mode is selected.
- Desired temperature is displayed about 5 seconds if you press **FAN SPEED**,  or  button.
- Room temperature is displayed about 5 seconds if you press **ROOM TEMP** button.

Using Special Functions

- 1 Turn the appliance on.
- 2 Press **FUNC** button repeatedly to select the desired function.
- 3 Press **SET/CANCEL** button to finish.

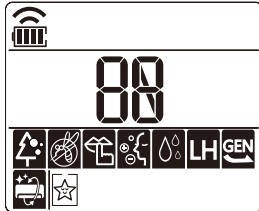

Display Screen	Description	Available Function	
		Single Split	Multi
	The Ion generator uses millions of ions to help improve indoor air quality.	X	X
	To reduce noise from outdoor units.	X	X
	To keep your skin moisturized by generating ion clusters.	X	X
	To lower indoor humidity quickly.	X	X
	To maintain a minimum room temperature and prevent objects in the room from freezing.	O (Optional)	X
	To scare away a mosquito.	X	X
	To remove moisture generated inside the indoor unit.	O	O
	To make a comfortable sleeping environment.	X	X

NOTE

- Some functions may not be supported, depending on the model.
- Some functions may operate differently from the remote control display.

Canceling Special Functions

- 1 Press **FUNC** button repeatedly to select the desired function.
- 2 Press **SET/CANCEL** button to cancel the function.

Using the Air Purification Function

These functions supply clean and fresh air by ion particles and the filter.

Function	Display	Description
Ionizer		Ion particles from ionizer reduce the surface bacteria and other harmful substances.
Plasma		It removes microscopic contaminants from the intake air completely to supply clean and fresh air.

NOTE

- You can use this function without turning the air conditioner on.
- Both the plasma lamp and the cooling lamp light up while Smoke Away/Plasma is in operation on some models.
- Do not touch ionizer during operation.
- This function may operate differently from the remote control display.

Using the Silent Function (Optional)

This function prevents potential claims by neighbors, reducing noise from outdoor units.

-  is displayed on the display screen.

NOTE

- This function is disabled when you press **MODE** or **ENERGY CTRL** or **JET MODE** button.
- This function is available with Cooling, Heating, Auto Changeover, Auto Operation Mode.

Using the Ion Care Function (Optional)

This function keeps your skin moisturized by generating ion clusters which is absorbed into the surface of skin.

-  is displayed on the display screen about 3 seconds.

NOTE

- This function is available with Cooling, Fan Mode and Air Purification function.

Using the Jet Dry Function (Optional)

This function maximizes the performance of dehumidification.

-   are displayed on the display screen.

NOTE



- This function is available with Cooling, Dehumidification, Auto Operation, Fan Mode and Air Purification function.
- This function is not available with Sleep function.
- This function is disabled when you press **MODE** button.

Using the Low Heating Function (Optional)

This function operates the heating system to maintain a minimum room temperature and prevent objects in the room from freezing where there is no permanent resident, such as a vacation.

-  LH are displayed on the display screen.

NOTE

- This function is available with Heating Mode.
- During LH operation, when you press buttons such as , , **MODE**, **FAN SPEED**, and then return to Heating Mode.
- If **JET MODE** button is pressed during LH operation, this function is disabled and Power Heating Mode is operated immediately. (only for power heating model)
- In case an error occurred, operation can be interrupted for the protection of the product.
- **COMFORT AIR** and  button cannot be used while the LH function is in operation.

Using the Mosquito Away Function (Optional)

This function fans away mosquitos by generating a high-frequency wave.

-  is displayed on the display screen.

NOTE

- You can use this function without turning the air conditioner on.
-  is displayed on some indoor units.

Using the Auto Clean Function

In the Cooling and Dehumidification Mode, moisture is generated inside the indoor unit. This function removes such moisture.

-  is displayed on the display screen.

NOTE

- Some functions cannot be used while the Auto Clean function is in operation.
- If you turn off the unit, the fan continues to run for 30 minutes and cleans the inside of the indoor unit.
-  is displayed on some indoor units, depending on the model.

Using the Comfort Sleep Function (Optional)

This function operates the air conditioner automatically to make the comfortable sleep environment.

- , SL are displayed on the display screen.

NOTE

- This function is available with Cooling Mode.
- The vane stops swing and sets indirect airflow angle, after 30 minutes from start even though the room temperature doesn't decrease to optimal temperature to sleep.
- It is possible that a comfortable sleep environment is different according to the people.

SMART FUNCTIONS

LG ThinQ Application

This feature is only available on models with the  or **ThinQ** logo.

The **LG ThinQ** application allows you to communicate with the appliance using a smartphone.

LG ThinQ Application Features

Communicate with the appliance from a smartphone using the convenient smart features.

Smart Diagnosis™

If you experience a problem while using the appliance, this smart diagnosis feature will help you diagnose the problem.

Settings

Allows you to set various options on the appliance and in the application.

NOTE

- If you change your wireless router, internet service provider, or password, delete the registered appliance from the **LG ThinQ** application and register it again.
- The application is subject to change for appliance improvement purposes without notice to users.
- Functions may vary by model.

Before Using LG ThinQ Application

- 1 Check the distance between the appliance and the wireless router (Wi-Fi network).
 - If the distance between the appliance and the wireless router is too far, the signal strength becomes weak. It may take a long time to register or installation may fail.

- 2 Turn off the **Mobile data** or **Cellular Data** on your smartphone.

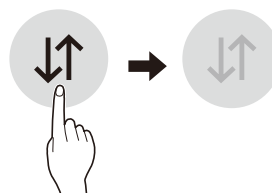

- 3 Connect your smartphone to the wireless router.

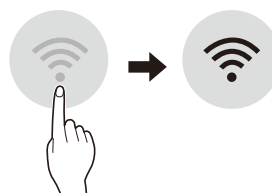

NOTE

- To verify the Wi-Fi connection, check that  icon on the control panel is lit.
- The appliance supports 2.4 GHz Wi-Fi networks only. To check your network frequency, contact your Internet service provider or refer to your wireless router manual.
- **LG ThinQ** is not responsible for any network connection problems or any faults, malfunctions, or errors caused by network connection.
- If the appliance is having trouble connecting to the Wi-Fi network, it may be too far from the router. Purchase a Wi-Fi repeater (range extender) to improve the Wi-Fi signal strength.
- The Wi-Fi connection may not connect or may be interrupted because of the home network environment.
- The network connection may not work properly depending on the Internet service provider.
- The surrounding wireless environment can make the wireless network service run slowly.

- The appliance cannot be registered due to problems with the wireless signal transmission. Unplug the appliance and wait about a minute before trying again.
- If the firewall on your wireless router is enabled, disable the firewall or add an exception to it.
- The wireless network name (SSID) should be a combination of English letters and numbers. (Do not use special characters.)
- Smartphone user interface (UI) may vary depending on the mobile operating system (OS) and the manufacturer.
- If the security protocol of the router is set to **WEP**, you may fail to set up the network. Please change it to other security protocols (**WPA2** is recommended) and register the product again.

Installing the LG ThinQ Application

Search for the **LG ThinQ** application from the Google Play Store or Apple App Store on a smartphone. Follow instructions to download and install the application.



Open Source Software Notice Information

To obtain the source code under GPL, LGPL, MPL, and other open source licenses, that is contained in this product, please visit <https://opensource.lge.com>.

In addition to the source code, all referred license terms, warranty disclaimers and copyright notices are available for download.

LG Electronics will also provide open source code to you on CD-ROM for a charge covering the cost of performing such distribution (such as the cost of media, shipping, and handling) upon email request to opensource@lge.com. This offer is valid for a period of three years after our last shipment of this product. This offer is valid to anyone in receipt of this information.

Smart Diagnosis™

This feature is only available on models with the  or  logo.

Use this feature to help you diagnose and solve problems with your appliance.

NOTE

- For reasons not attributable to LGE's negligence, the service may not operate due to external factors such as, but not limited to, Wi-Fi unavailability, Wi-Fi disconnection, local app store policy, or app unavailability.
- The feature may be subject to change without prior notice and may have a different form depending on where you are located.

Using LG ThinQ to Diagnose Issues



If you experience a problem with your Wi-Fi equipped appliance, it can transmit troubleshooting data to a smartphone using the **LG ThinQ** application.

- Launch the **LG ThinQ** application and select the **Smart Diagnosis™** feature in the menu. Follow the instructions provided in the **LG ThinQ** application.

Using Audible Diagnosis to Diagnose Issues

Follow the instructions below to use the audible diagnosis method.

- Launch the **LG ThinQ** application and select the **Smart Diagnosis™** feature in the menu. Follow the instructions for audible diagnosis provided in the **LG ThinQ** application.

- 1 Plug the power plug in the outlet properly.
- 2 Place the mouthpiece of your smartphone close to the  or  logo.
- 3 Press and hold the **DIAGNOSIS [5 s]** button for 5 seconds or longer while holding the smartphone mouthpiece to the logo until the data transfer is complete.
 - Keep the smartphone in place until the data transfer has finished. Time remaining for data transfer is displayed.
- 4 After the data transfer is complete, the diagnosis will be displayed in the application.

NOTE

- For best results, do not move the phone while the tones are being transmitted.
- Be sure to keep ambient noise to a minimum or the phone may not correctly receive the buzzer beeps from the indoor unit.

MAINTENANCE

⚠ WARNING

- Before cleaning or performing maintenance, disconnect the power supply and wait until the fan stops.

If the air conditioner will not be used for an extended period of time, dry the air conditioner to maintain it in best condition. Clean the product regularly to maintain optimal performance and to prevent possible breakdown.

- Dry the air conditioner in Fan mode for 3 to 4 hours and disconnect the power. There may be internal damage if moisture is left in its components.
- Before using the air conditioner again, dry the inner components of the air conditioner in Fan mode for 3 to 4 hours. This will help to remove the odor generated from moisture.

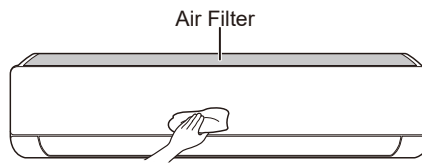

- The feature may be changed according to the type of model.

Type	Description	Interval
Air filter	Clean with a vacuum or hand wash.	2 weeks
Triple filter	Clean with a vacuum or brush.	Every 3 months
Micro dust filter	Clean with a vacuum or brush.	Once a month
Ionizer (Optional)	Use dry cotton bud to remove any dust.	Every 6 months
Indoor unit	Clean the Indoor unit surface by using a soft, dry cloth.	Regularly
	Have a professional clean the condensate drain pan.	Once a year
	Have a professional clean the condensate drain pipe.	Every 4 months
	Replace the remote control batteries.	Once a year
Outdoor unit	Have a professional clean the heat exchanger coils and the panel vents. (Consult with technician.)	Once a year
	Have a professional clean the fan.	Once a year
	Have a professional clean the condensate drain pan.	Once a year
	Have a professional verify that all the fan assembly is firmly tightened.	Once a year
	Clean the electric components with air.	Once a year

NOTE

- Never use water that is higher than 40 °C when you clean the filters. It may cause deformation or discoloration.
- Never use volatile substances when you clean the filters. They may damage the surface of the product.
- Do not wash the Micro dust filter with water, because the filter can be damaged (Optional).
- Do not wash the Triple filter with water, because the filter can be damaged (Optional).

Clean the Air Filter

Clean the air filters once every 2 weeks, or more, if necessary.

NOTE

- The air filter can be broken when it is bent.
- When the air filter is not assembled correctly, dust and other substances can enter into the indoor unit.

Type1

If you look at the indoor unit from above it, can assemble the top filter easily.

- 1 Turn off the power to the unit.
- 2 Hold the knobs of the air filter, lift it up slightly.

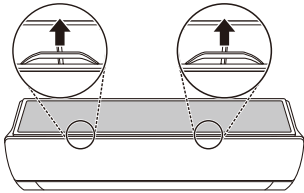

- 3 Remove it from the indoor unit.

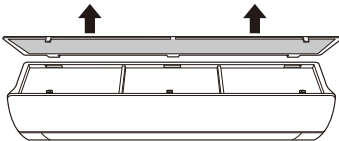

- 4 Clean the filter with a vacuum cleaner or with lukewarm water with neutral detergent.
- 5 Dry the filter in the shade.
- 6 Insert the hooks of the air filter into the front cover.

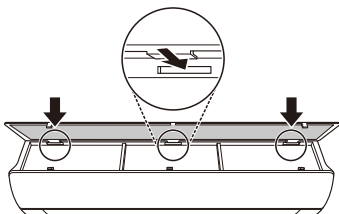

- 7 Push down hooks to assemble the air filter.

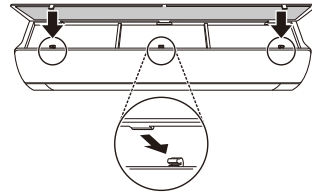

- 8 Check the side of the front cover for correct assembly of the air filter.

Type2

- 1 Turn off the power to the unit.
- 2 Open the front cover.
 - Lift up both sides of the cover slightly.
- 3 Hold the knobs of the air filters, pull them down slightly and remove them from the indoor unit.

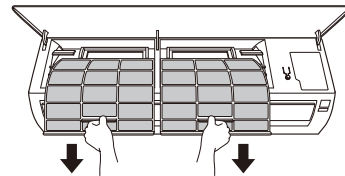

- 4 Clean the filters with a vacuum cleaner or with lukewarm water with neutral detergent.
- 5 Dry the filters in the shade.
- 6 Insert the hooks of the air filters into the front cover.

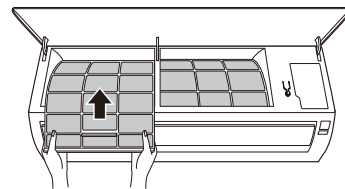

- 7 Check the side of the front cover for correct assembly of the air filters.

Clean the Micro Dust and Triple Filter (Optional)

- 1 Turn off the power to the unit.
- 2 Remove the air filters from the indoor unit.
- 3 Remove the Micro dust and Triple filter from the indoor unit.

Type1

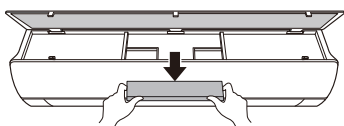

Type2

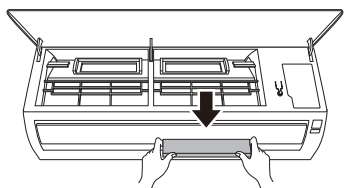

- 4 Clean the filter with a vacuum cleaner.

- 5 Insert the Micro dust and Triple filter.

Type1

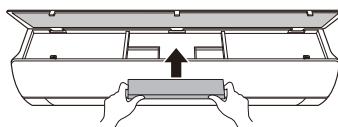

Type2

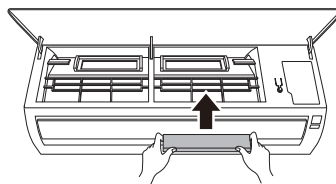

- 6 Assemble the air filters.
- 7 Check the side of the front cover for correct assembly of the air filters.

NOTE

- The feature and location of Micro dust and Triple filter may vary according to the type of model.

TROUBLESHOOTING

Self-diagnosis Function

This product has a built-in self-diagnosis function. If an error occurs, the lamp of the indoor unit will blink in 2 second intervals. If this occurs, contact your local dealer or service center.

Before Calling for Service

Please check the following before you contact the service center. If the problem persists, contact your local service center.

Symptoms	Possible Causes & Solution
The air conditioner does not work normally.	Burning smell and strange sounds are coming from the unit. <ul style="list-style-type: none"> Turn off the air conditioner, switch OFF, or disconnect the power supply, and contact the service center.
	Water leaks from the indoor unit even when the humidity level is low. <ul style="list-style-type: none"> Turn off the air conditioner, switch OFF, or disconnect the power supply, and contact the service center.
	The power cable is damaged or it is generating excessive heat. <ul style="list-style-type: none"> Turn off the air conditioner, switch OFF, or disconnect the power supply, and contact the service center.
	A switch, a circuit breaker (safety, ground), or a fuse is not operated properly. <ul style="list-style-type: none"> Turn off the air conditioner, switch OFF, or disconnect the power supply, and contact the service center.
	The unit generates an error code from its self-diagnosis. <ul style="list-style-type: none"> Turn off the air conditioner, switch OFF, or disconnect the power supply, and contact the service center.
The air conditioner does not work.	The air conditioner is unplugged. <ul style="list-style-type: none"> Check whether the power cord is plugged into the outlet or the power isolators are switched on.
	A fuse exploded, or the power supply is blocked. <ul style="list-style-type: none"> Replace the fuse or check if the circuit breaker has tripped.
	A power failure has occurred. <ul style="list-style-type: none"> Turn off the air conditioner when a power failure occurs. When the power is restored, wait 3 minutes, and then turn on the air conditioner.
	The voltage is too high or too low. <ul style="list-style-type: none"> Check if the circuit breaker has tripped.
	The air conditioner was turned off automatically at a preset time. <ul style="list-style-type: none"> Turn the air conditioner on.
	The battery setting in the remote controller is incorrect. <ul style="list-style-type: none"> Make sure that the batteries are inserted correctly in your remote controller. If the batteries are placed correctly, but the air conditioner still does not operate, replace the batteries and try again.

Symptoms	Possible Causes & Solution
The air conditioner does not emit cool air.	Air is not circulating properly. <ul style="list-style-type: none"> • Make sure that there are no curtains, blinds, or pieces of furniture blocking the front of the air conditioner.
	The air filter is dirty. <ul style="list-style-type: none"> • Clean the air filter once every 2 weeks. • See “Clean the Air Filter” for more information.
	The room temperature is too high. <ul style="list-style-type: none"> • In summer, cooling the indoor air fully may take some time. In this case, select the Jet Mode to cool the indoor air quickly.
	Cold air is escaping from the room. <ul style="list-style-type: none"> • Make sure that no cold air is escaping through the ventilation points in the room.
	The desired temperature is higher than the current temperature. <ul style="list-style-type: none"> • Set the desired temperature to a level lower than the current temperature.
	There is a heating source nearby. <ul style="list-style-type: none"> • Avoid using heat generators like electric ovens or gas burners while the air conditioner is in operation.
	Fan Mode is selected. <ul style="list-style-type: none"> • During Fan Mode, air blows from the air conditioner without cooling or heating the indoor air. • Switch the operation mode to cooling operation.
	Outside temperature is too high. <ul style="list-style-type: none"> • The cooling effect may not be sufficient.
The fan speed cannot be adjusted.	The Jet Mode, or Auto Operation Mode is selected. <ul style="list-style-type: none"> • In some operation modes, you cannot adjust the fan speed. Select an operation mode in which you can adjust the fan speed.
The temperature cannot be adjusted.	The Fan Mode or Jet Mode is selected. <ul style="list-style-type: none"> • In some operation modes, you cannot adjust the temperature. Select an operation mode in which you can adjust the temperature.
The air conditioner stops during operation.	The air conditioner is suddenly turned off. <ul style="list-style-type: none"> • The Timer Function may have timed out, which turns the unit off. Check the timer settings.
	A power failure has occurred during operation. <ul style="list-style-type: none"> • Wait for the power to come back. If you have the Auto Restart function enabled, your unit will resume its last operation several minutes after power is restored.

Symptoms	Possible Causes & Solution
The indoor unit is still operating even when the unit has been turned off.	<p>The Auto Clean function is being operated.</p> <ul style="list-style-type: none"> • Allow the Auto Clean function to continue since it removes any remaining moisture inside the indoor unit. If you do not want this feature, you can turn the unit off.
The air outlet on the indoor unit is discharging mist.	<p>The cooled air from the air conditioner makes mist.</p> <ul style="list-style-type: none"> • When the room temperature decreases, this phenomenon will disappear.
Water leaks from the outdoor unit.	<p>In the heating operations, condensed water drops from the heat exchanger.</p> <ul style="list-style-type: none"> • This symptom requires installing a drain hose under the base pan. Contact the installer.
There is noise or vibration.	<p>A clicking sound can be heard when the unit starts or stops due to movement of the reversing valve.</p> <p>Creaking sound: The plastic parts of the indoor unit creak when they shrink or expand due to sudden temperature changes.</p> <p>Flowing or Blowing sound: This is the flow of refrigerant through the air conditioner.</p> <ul style="list-style-type: none"> • These are normal symptoms. The noise will stop.
The indoor unit gives off an odor.	<p>Odors (such as cigarette smoke) may be absorbed into the indoor unit and discharged with airflow.</p> <ul style="list-style-type: none"> • If the smell does not disappear, you need to wash the filter. If this does not work, contact the service center to clean your heat exchanger.
The air conditioner does not emit warm air.	<p>When Heating Mode starts, the vane is almost closed, and no air comes out, even though the outdoor unit is operating.</p> <ul style="list-style-type: none"> • This symptom is normal. Please wait until the unit has generated enough warm air to blow through the indoor unit.
	<p>The outdoor unit is in Defrosting Mode.</p> <ul style="list-style-type: none"> • In Heating Mode, ice/frost is built up on the coils when the outside temperature falls. This function removes a layer of frost on the coil, and it should finish in approximately 15 minutes.
	<p>Outside temperature is too low.</p> <ul style="list-style-type: none"> • The heating effect may not be sufficient.

Symptoms	Possible Causes & Solution
Your home appliance and smartphone is not connected to the Wi-Fi network.	The password for the Wi-Fi that you are trying to connect to is incorrect. <ul style="list-style-type: none"> Find the Wi-Fi network connected to your smartphone and remove it, then register your appliance on LG ThinQ.
	Mobile data for your smartphone is turned on. <ul style="list-style-type: none"> Turn off the Mobile data of your smartphone and register the appliance using the Wi-Fi network.
	The wireless network name (SSID) is set incorrectly. <ul style="list-style-type: none"> The wireless network name (SSID) should be a combination of English letters and numbers. (Do not use special characters.)
	The router frequency is not 2.4 GHz. <ul style="list-style-type: none"> Only a 2.4 GHz router frequency is supported. Set the wireless router to 2.4 GHz and connect the appliance to the wireless router. To check the router frequency, check with your Internet service provider or the router manufacturer.
	The distance between the appliance and the router is too far. <ul style="list-style-type: none"> If the distance between the appliance and the router is too far, the signal may be weak and the connection may not be configured correctly. Move the location of the router so that it is closer to the appliance.

NOTE

- Some functions may not be supported, depending on the model.

WARRANTY (USA)

ARBITRATION NOTICE: THIS LIMITED WARRANTY CONTAINS AN ARBITRATION PROVISION THAT REQUIRES YOU AND LG TO RESOLVE DISPUTES BY BINDING ARBITRATION INSTEAD OF IN COURT, UNLESS YOU CHOOSE TO OPT OUT. IN ARBITRATION, CLASS ACTIONS AND JURY TRIALS ARE NOT PERMITTED. PLEASE SEE THE SECTION TITLED "PROCEDURE FOR RESOLVING DISPUTES" BELOW.

PROCEDURE FOR RESOLVING DISPUTES:

ALL DISPUTES BETWEEN YOU AND LG ARISING OUT OF OR RELATING IN ANY WAY TO THIS LIMITED WARRANTY OR THE PRODUCT SHALL BE RESOLVED EXCLUSIVELY THROUGH BINDING ARBITRATION, AND NOT IN A COURT OF GENERAL JURISDICTION. BINDING ARBITRATION MEANS THAT YOU AND LG ARE EACH WAIVING THE RIGHT TO A JURY TRIAL AND TO BRING OR PARTICIPATE IN A CLASS ACTION.

Definitions. For the purposes of this section, references to "LG" mean LG Electronics U.S.A., Inc., its parents, subsidiaries and affiliates, and each of their officers, directors, employees, agents, beneficiaries, predecessors in interest, successors, assigns and suppliers; references to "dispute" or "claim" shall include any dispute, claim or controversy of any kind whatsoever (whether based in contract, tort, statute, regulation, ordinance, fraud, misrepresentation or any other legal or equitable theory) arising out of or relating in any way to the sale, condition or performance of the product or this Limited Warranty.

Notice of Dispute. In the event you intend to commence an arbitration proceeding, you must first notify LG in writing at least 30 days in advance of initiating the arbitration by sending a letter to LG at LG Electronics, USA, Inc. Attn: Legal Department- Arbitration 111 Sylvan Avenue, Englewood Cliffs, NJ 07632. You and LG agree to engage in good faith discussions in an attempt to amicably resolve your claim. The notice must provide your name, address, and telephone number; identify the product that is the subject of the claim; and describe the nature of the claim and the relief being sought. If you and LG are unable to resolve the dispute within 30 days, either party may proceed to file a claim for arbitration.

Agreement to Binding Arbitration and Class Action Waiver. Upon failure to resolve the dispute during the 30 day period after sending written notice to LG, you and LG agree to resolve any claims between us only by binding arbitration on an individual basis, unless you opt out as provided below. Any dispute between you and LG shall not be combined or consolidated with a dispute involving any other person's or entity's product or claim. More specifically, without limitation of the foregoing, any dispute between you and LG shall not under any circumstances proceed as part of a class or representative action. Instead of arbitration, either party may bring an individual action in small claims court, but that small claims court action may not be brought on a class or representative basis.

Arbitration Rules and Procedures. To begin arbitration of a claim, either you or LG must make a written demand for arbitration. The arbitration will be administered by the American Arbitration Association ("AAA") and will be conducted before a single arbitrator under the AAA's Consumer Arbitration Rules that are in effect at the time the arbitration is initiated (referred to as the "AAA Rules") and under the procedures set forth in this section. The AAA Rules are available online at www.adr.org/consumer. Send a copy of your written demand for arbitration, as well as a copy of this provision, to the AAA in the manner described in the AAA Rules. You must also send a copy of your written demand to LG at LG Electronics, USA, Inc. Attn: Legal Department- Arbitration 111 Sylvan Avenue, Englewood Cliffs, NJ 07632. If there is a conflict between the AAA Rules and the rules set forth in this section, the rules set forth in this section will govern. This arbitration provision is governed by the Federal Arbitration Act. Judgment may be entered on the arbitrator's award in any court of competent jurisdiction. All issues are for the arbitrator to decide, except that issues relating to the scope and enforceability of the arbitration provision and to the arbitrability of the dispute are for the court to decide. The arbitrator is bound by the terms of this provision.

Governing Law. The law of the state of your residence shall govern this Limited Warranty and any disputes between us except to the extent that such law is preempted by or inconsistent with applicable federal law.

Fees/Costs. You do not need to pay any fee to begin an arbitration. Upon receipt of your written demand for arbitration, LG will promptly pay all arbitration filing fees to the AAA unless you seek more than \$25,000 in damages, in which case the payment of these fees will be governed by the AAA Rules. Except as otherwise provided for herein, LG will pay all AAA filing, administration and arbitrator fees for any arbitration initiated in accordance with the AAA Rules and this arbitration provision. If you prevail in the arbitration, LG will pay your attorneys' fees and expenses as long as they are reasonable, by considering factors including, but not limited to, the purchase amount and claim amount. Notwithstanding the foregoing, if applicable law allows for an award of reasonable attorneys' fees and expenses, an arbitrator can award them to the same extent that a court would. If the arbitrator finds either the substance of your claim or the relief sought in the demand is frivolous or brought for an improper purpose (as measured by the standards set forth in Federal Rule of Civil Procedure 11(b)), then the payment of all arbitration fees will be governed by the AAA Rules. In such a situation, you agree to reimburse LG for all monies previously disbursed by it that are otherwise your obligation to pay under the AAA Rules. Except as otherwise provided for, LG waives any rights it may have to seek attorneys' fees and expenses from you if LG prevails in the arbitration.

Hearings and Location. If your claim is for \$25,000 or less, you may choose to have the arbitration conducted solely on the basis of (1) documents submitted to the arbitrator, (2) through a telephonic hearing, or (3) by an in-person hearing as established by the AAA Rules. If your claim exceeds \$25,000, the right to a hearing will be determined by the AAA Rules. Any in-person arbitration hearings will be held at a location within the federal judicial district in which you reside unless we both agree to another location or we agree to a telephonic arbitration.

Opt Out. You may opt out of this dispute resolution procedure. If you opt out, neither you nor LG can require the other to participate in an arbitration proceeding. To opt out, you must send notice to LG no later than 30 calendar days from the date of the first consumer purchaser's purchase of the product by either: (i) sending an e-mail to optout@lge.com, with the subject line: "Arbitration Opt Out" or (ii) calling 1-800-980-2973. You must include in the opt out e-mail or provide by telephone: (a) your name and address; (b) the date on which the product was purchased; (c) the product model name or model number; and (d) the serial number (the serial number can be found (i) on the product; or (ii) online by accessing <https://www.lg.com/us/support/repair-service/schedule-repair-continued> and clicking on "Find My Model & Serial Number").

You may only opt out of the dispute resolution procedure in the manner described above (that is, by e-mail or telephone); no other form of notice will be effective to opt out of this dispute resolution procedure. Opting out of this dispute resolution procedure will not affect the coverage of the Limited Warranty in any way, and you will continue to enjoy the full benefits of the Limited Warranty. If you keep this product and do not opt out, then you accept all terms and conditions of the arbitration provision described above.

WARRANTY (CANADA)

ARBITRATION NOTICE: THIS LIMITED WARRANTY CONTAINS AN ARBITRATION PROVISION THAT REQUIRES YOU AND LG TO RESOLVE DISPUTES BY BINDING ARBITRATION INSTEAD OF IN COURT, UNLESS THE LAWS OF YOUR PROVINCE OR TERRITORY DO NOT PERMIT THAT, OR, IN OTHER JURISDICTIONS, IF YOU CHOOSE TO OPT OUT. IN ARBITRATION, CLASS ACTIONS AND JURY TRIALS ARE NOT PERMITTED. PLEASE SEE THE SECTION TITLED “PROCEDURE FOR RESOLVING DISPUTES” BELOW.

PROCEDURE FOR RESOLVING DISPUTES:

EXCEPT WHERE PROHIBITED AT LAW, ALL DISPUTES BETWEEN YOU AND LG ARISING OUT OF OR RELATING IN ANY WAY TO THIS LIMITED WARRANTY OR THE PRODUCT SHALL BE RESOLVED EXCLUSIVELY THROUGH BINDING ARBITRATION, AND NOT IN A COURT OF GENERAL JURISDICTION. EXCEPT WHERE PROHIBITED AT LAW, YOU AND LG BOTH IRREVOCABLY AGREE TO WAIVE THE RIGHT TO A JURY TRIAL AND TO BRING OR PARTICIPATE IN A CLASS ACTION.

Definitions. For the purposes of this section, references to “LG” mean LG Electronics Canada, Inc., its parents, subsidiaries and affiliates, and each of their officers, directors, employees, agents, beneficiaries, predecessors in interest, successors, assigns and suppliers; references to “dispute” or “claim” shall include any dispute, claim or controversy of any kind whatsoever (whether based in contract, tort, statute, regulation, ordinance, fraud, misrepresentation or any other legal or equitable theory) arising out of or relating in any way to the sale, condition or performance of the product or this Limited Warranty.

Notice of Dispute. In the event you intend to commence an arbitration proceeding, you must first notify LG in writing at least 30 days in advance of initiating the arbitration by sending a letter to LGECI Legal Team at 20 Norelco Drive, North York, Ontario, Canada M9L 2X6 (the “Notice of Dispute”). You and LG agree to engage in good faith discussions in an attempt to amicably resolve your claim. The notice must provide your name, address, and telephone number; identify the product that is the subject of the claim; and describe the nature of the claim and the relief being sought. If you and LG are unable to resolve the dispute within 30 days of LG’s receipt of the Notice of Dispute, the dispute shall be resolved by binding arbitration in accordance with the procedure set out herein. You and LG both agree that, during the arbitration proceeding, the terms (including any amount) of any settlement offer made by either you or LG will not be disclosed to the arbitrator until the arbitrator determines the dispute.

Agreement to Binding Arbitration and Class Action Waiver. Upon failure to resolve the dispute during the 30 day period after LG’s receipt of the Notice of Dispute, you and LG agree to resolve any claims between you and LG only by binding arbitration on an individual basis, unless you opt out as provided below, or you reside in a jurisdiction that prevents full application of this clause in the circumstances of the claims at issue (in which case if you are a consumer, this clause will only apply if you expressly agree to the arbitration). To the extent permitted by applicable law, any dispute between you and LG shall not be combined or consolidated with a dispute involving any other person’s or entity’s product or claim. More specifically, without limitation of the foregoing, except to the extent such a prohibition is not permitted at law, any dispute between you and LG shall not under any circumstances proceed as part of a class or representative action. Instead of arbitration, either party may bring an individual action in small claims court, but that small claims court action may not be brought on a class or representative basis except to the extent this prohibition is not permitted at law in your province or territory of jurisdiction as it relates to the claims at issue between you and LG.

Arbitration Rules and Procedures. To begin arbitration of a claim, either you or LG must make a written demand for arbitration. The arbitration will be private and confidential, and conducted on a simplified and expedited basis before a single arbitrator chosen by the parties under the provincial or territorial commercial arbitration law and rules of the province or territory of your residence. You must also send a copy of your written demand to LG at LG Electronics, Canada, Inc., Attn: Legal Department- Arbitration, 20 Norelco Drive, North York, Ontario M9L 2X6. This arbitration provision is governed by your applicable provincial or territorial commercial arbitration legislation. Judgment may be entered on the arbitrator’s award in any court of competent jurisdiction. All issues are for the arbitrator to decide, except that, issues relating to the scope and enforceability of the arbitration provision and to the arbitrability of the dispute are for the court to decide. The arbitrator is bound by the terms of this provision.

Governing Law. The law of the province or territory of your purchase shall govern this Limited Warranty and any disputes between you and LG except to the extent that such law is preempted by or inconsistent with applicable federal or provincial/territorial law. Should arbitration not be permitted for any claim, action, dispute or controversy between you and LG, you and LG attorn to the exclusive jurisdiction of the courts of the province or territory of your purchase for the resolution of the claim, action, dispute or controversy between you and LG.

Fees/Costs. You do not need to pay any fee to begin an arbitration. Upon receipt of your written demand for arbitration, LG will promptly pay all arbitration filing fees unless you seek more than \$25,000 in damages, in which case the payment of these fees will be governed by the applicable arbitration rules. Except as otherwise provided for herein, LG will pay all filing, administration and arbitrator fees for any arbitration initiated in accordance with the applicable arbitration rules and this arbitration provision. If you prevail in the arbitration, LG will pay your attorneys' fees and expenses as long as they are reasonable, by considering factors including, but not limited to, the purchase amount and claim amount. Notwithstanding the foregoing, if applicable law allows for an award of reasonable attorneys' fees and expenses, an arbitrator can award them to the same extent that a court would. If the arbitrator finds either the substance of your claim or the relief sought in the demand is frivolous or brought for an improper purpose (as measured by the applicable laws), then the payment of all arbitration fees will be governed by the applicable arbitration rules. In such a situation, you agree to reimburse LG for all monies previously disbursed by it that are otherwise your obligation to pay under the applicable arbitration rules. Except as otherwise provided for, LG waives any rights it may have to seek attorneys' fees and expenses from you if LG prevails in the arbitration.

Hearings and Location. If your claim is for \$25,000 or less, you may choose to have the arbitration conducted solely (1) on the basis of documents submitted to the arbitrator, (2) through a telephonic hearing, or (3) by an in-person hearing as established by the applicable arbitration rules. If your claim exceeds \$25,000, the right to a hearing will be determined by the applicable arbitration rules. Any in-person arbitration hearings will be held at the nearest, most mutually-convenient arbitration location available within the province or territory in which you reside unless you and LG both agree to another location or agree to a telephonic arbitration.

Severability and Waiver. If any portion of this Limited Warranty (including these arbitration procedures) is unenforceable, the remaining provisions will continue in full force and effect to the maximum extent permitted by applicable law. Should LG fail to enforce strict performance of any provision of this Limited Warranty (including these arbitration procedures), it does not mean that LG intends to waive or has waived any provision or part of this Limited Warranty.

Opt Out. You may opt out of this dispute resolution procedure. If you opt out, neither you nor LG can require the other to participate in an arbitration proceeding. To opt out, you must send notice to LG no later than 30 calendar days from the date of the first consumer purchaser's purchase of the product by either (i) sending an e-mail to optout@lge.com, with the subject line: "Arbitration Opt Out;" or (ii) calling 1-800-980-2973. You must include in the opt out e-mail or provide by telephone: (a) your name and address; (b) the date on which the product was purchased; (c) the product model name or model number; and (d) the serial number (the serial number can be found (i) on the product; or (ii) online by accessing https://www.lg.com/ca_en/support/repair-service/schedule-repair and clicking on "Find My Model & Serial Number").

In the event that you "Opt Out", the law of the province or territory of your residence shall govern this Limited Warranty and any disputes between you and LG except to the extent that such law is preempted by or inconsistent with applicable federal or provincial/territorial law. Should arbitration not be permitted for any claim, action, dispute or controversy between you and LG, you and LG agree to attorn to the exclusive jurisdiction of the courts of the province or territory of your residence for the resolution of the claim, action, dispute or controversy between you and LG.

You may only opt out of the dispute resolution procedure in the manner described above (that is, by e-mail or telephone); no other form of notice will be effective to opt out of this dispute resolution procedure. Opting out of this dispute resolution procedure will not affect the coverage of the Limited Warranty in any way, and you will continue to enjoy the full benefits of the Limited Warranty. If you keep this product and do not opt out, then you accept all terms and conditions of the arbitration provision described above.

Conflict of Terms. In the event of a conflict or inconsistency between the terms of this Limited Warranty and the End User License Agreement ("EULA") in regards to dispute resolution, the terms of this Limited Warranty shall control and govern the rights and obligations of the parties and shall take precedence over the EULA.



US	Please call the installing contractor of your product, as warranty service will be provided by them.
CANADA	Service call Number # : (888) LG Canada, (888) 542-2623 Numéro pour les appels de service : LG Canada, 1-888-542-2623



OWNER'S MANUAL

AIR CONDITIONER



Read this owner's manual thoroughly before operating the appliance and keep it handy for reference at all times.

TYPE: WALL MOUNTED

ENGLISH



ENERGY STAR

If Indoor unit are connected with multi split type, It is not Energy Star certified products



MFL69491102
Rev.12_020521

www.lg.com

Copyright © 2017 - 2021 LG Electronics Inc. All Rights Reserved

TABLE OF CONTENTS

2 TABLE OF CONTENTS

3 SAFETY INSTRUCTIONS

3 IMPORTANT SAFETY INSTRUCTIONS

7 OPERATION

7 Notes for Operation
7 Parts and Functions
8 Wireless Remote Control
13 Restarting the Air Conditioner Automatically
13 Using the Mode Function
15 Using the Jet Mode Function
16 Using the Fan Speed Function
16 Using the Air Flow Direction Function
17 Setting the On/Off Timer
18 Using the Sleep Function (Optional)
18 Using the Simple Timer Function (Optional)
19 Using the Energy Display Function (Optional)
19 Using the Light Off Function (Optional)
19 Using the Comfort Air Function (Optional)
20 Using the Energy Saving Function (Optional)
20 Using the Energy Control Function (Optional)
21 Using Special Functions

24 SMART FUNCTIONS

24 LG ThinQ Application
26 Smart Diagnosis™

27 MAINTENANCE

29 Clean the Air Filter
30 Clean the Micro Dust and Triple Filter (Optional)

31 TROUBLESHOOTING

35 WARRANTY (USA)

37 WARRANTY (CANADA)

SAFETY INSTRUCTIONS

READ ALL INSTRUCTIONS BEFORE USE

Your safety and the safety of others are very important.

We have provided many important safety messages in this manual and on your appliance. Always read and follow all safety messages.

 This is the safety alert symbol.

This symbol alerts you to potential hazards that can kill or injure you and others.

All safety messages will follow the safety alert symbol and either the word **WARNING**, or **CAUTION**.

WARNING

If you do not follow instructions, it could result in death or serious injury.

CAUTION

If you do not follow instructions, it could result in minor or moderate injury or damage to the product.

All safety messages will tell you what the potential hazard is, tell you how to reduce the chance of injury, and tell you what may happen if the instructions are not followed.

IMPORTANT SAFETY INSTRUCTIONS

WARNING

To reduce the risk of explosion, fire, death, electric shock, injury or scalding to persons when using this product, follow basic precautions, including the following:

- Installation or repairs made by unauthorized persons can pose hazards to you and others.
- Installation **MUST** conform to the local building codes or, in the absence of local codes, the National Electrical Code NFPA 70/ANSI C1-1003 or current edition and Canadian Electrical Code Part1 CSA C.22. 1.
- The information contained in the manual is intended for use by a qualified service technician who is familiar with the safety procedures and equipped with the proper tools and test instruments.
- Failure to read and follow all instructions in this manual can result in equipment malfunction, property damage, personal injury and/or death.
- When the power cord is to be replaced, the replacement work shall be performed by authorized personnel using only genuine replacement parts.
- This appliance is not intended for use by persons (including children) with reduced physical, sensory or mental capabilities, or lack of experience and knowledge, unless they have been given supervision or instruction concerning use of the appliance by a person responsible for their safety. Children should be supervised to ensure that they do not play with the appliance.

Installation

- Do not install the air conditioner on an unstable surface or in a place where there is danger of it falling.
- Contact an authorized service center when installing or relocating the air conditioner.
- Install the panel and the cover of the control box safely.
- Do not install the air conditioner in a place where flammable liquids or gases such as gasoline, propane, paint thinner, etc., are stored.
- Make sure that the pipe and the power cable connecting the indoor and outdoor units are not pulled too tight when installing the air conditioner.
- Use standard circuit breaker and fuse that conform to the rating of the air conditioner.
- Do not input air or gas into the system except with the specific refrigerant.
- Use non-flammable gas (nitrogen) to check for leak and to purge air; using compressed air or flammable gas may cause fire or explosion.
- The indoor/outdoor wiring connections must be secured tightly, and the cable should be routed properly so that there is no force pulling the cable from the connection terminals. Improper or loose connections can cause heat generation or fire.
- Install dedicated electric outlet and circuit breaker before using the air conditioner.
- Do not connect the ground wire to a gas pipe, a lightning rod, or a telephone ground wire.
- If the supply cord is damaged, it must be replaced by the manufacturer, its service agent or similarly qualified person in order to avoid a hazard.
- Do not install the unit in potentially explosive atmospheres.

Operation

- Be sure to use only those parts listed in the service parts list. Never attempt to modify the equipment.
- Make sure that children do not climb on or hit the outdoor unit.
- Dispose of the batteries in a place where there is no danger of fire.
- Use only the refrigerant specified on the air conditioner label.
- Cut off the power supply if there is any noise, smell, or smoke coming from the air conditioner.
- Do not leave flammable substances such as gasoline, benzene, or thinner near the air conditioner.
- Contact an authorized service center when the air conditioner is submerged by flood waters.
- Do not use the air conditioner for an extended period of time in a small place without proper ventilation.
- In the event of a gas leak (such as Freon, propane gas, LP gas, etc.) ventilate sufficiently before using the air conditioner again.
- To clean the interior, contact an authorized service center or dealer. Using harsh detergents may cause corrosion or damage to the unit.

- Be sure to ventilate sufficiently when the air conditioner and a heating appliance such as a heater are used simultaneously.
- Do not block the inlet or outlet of air flow.
- Do not insert hands or other objects through the air inlet or outlet while the air conditioner is operating.
- Make sure that the power cable is neither dirty, loose, nor broken.
- Never touch, operate, or repair the air conditioner with wet hands.
- Do not place any objects on the power cable.
- Do not place a heater or other heating appliances near the power cable.
- Do not modify or extend the power cable. Scratches or peeling insulation on the power cables may result in fire or electric shock, and should be replaced.
- Cut off the power supply immediately in the event of a blackout or a thunderstorm.
- Take care to ensure that power cable could not be pulled out or damaged during operation.
- Do not touch refrigerant pipe, water pipe and any internal parts while the unit is operating or immediately after operation.

Maintenance

- Do not clean the appliance by spraying water directly onto the product.
- Before cleaning or performing maintenance, disconnect the power supply and wait until the fan stops.

CAUTION

To reduce the risk of minor injury to persons, malfunction, or damage to the product or property when using this product, follow basic precautions, including the following:

Installation

- Do not install the air conditioner in an area where it is directly exposed to sea wind (salt spray).
- Install the drain hose properly for the smooth drainage of water condensation.
- Exercise caution when unpacking or installing the air conditioner.
- Do not touch the leaking refrigerant during installation or repair.
- Transport the air conditioner with two or more people or use a forklift.
- Install the outdoor unit such that it is protected from direct sunlight. Do not place the indoor unit in a place where it is directly exposed to sunlight via the windows.
- Safely dispose of packing materials such as screws, nails, plastic bag or batteries using proper packaging after installation or repair.
- Install the air conditioner in a place where the noise from the outdoor unit or the exhaust fumes will not inconvenience the neighbors. Failure to do so may result in conflict with the neighbors.

Operation

- Remove the batteries if the remote control is not to be used for an extended period of time.
- Make sure that the filter is installed before operating the air conditioner.
- Be sure to check if there is a refrigerant leak after installing or repairing the air conditioner.
- Follow the standards of the corresponding region or country for handling the refrigerant and the air conditioner and for disassembling the air conditioner.
- Do not place any object on the air conditioner.
- Never mix different types of batteries, or old and new batteries for the remote control.
- Do not let the air conditioner run for a long time when humidity is very high or when a door or a window has been left open.
- Stop using the remote control if there is a fluid leak in the battery. If your clothes or skin are exposed to the leaking battery fluid, wash off with clean water.
- Do not expose people, animals, or plants to the cold or hot wind from the air conditioner for extended periods of time.
- If the leaking battery fluid has been swallowed, rinse the inside of the mouth thoroughly and consult a doctor.
- Do not drink the water drained from the air conditioner.
- Do not use the product for special purposes, such as preserving foods, works of art, and etc. It is an air conditioner for consumer purposes, not a precision refrigeration system. There is risk of damage or loss of property.
- Do not recharge or disassemble the batteries.

Maintenance

- Never touch the metal parts of the air conditioner when removing the air filter.
- Use a sturdy stool or ladder when cleaning, maintaining, or repairing the air conditioner at a height.
- Never use strong cleaning agents or solvents when cleaning the air conditioner or spray water. Use a smooth cloth.

OPERATION

Notes for Operation

Suggestion for Energy Saving

- Do not over-cool the space. This may be harmful for your health and may consume more electricity.
- Block sunlight with blinds or curtains while you are operating the air conditioner.
- Keep doors or windows closed tightly while you are operating the air conditioner.
- Adjust the direction of the air flow vertically or horizontally to circulate indoor air.
- Speed up the fan to cool or warm indoor air quickly, within a short period of time.
- Open windows regularly for ventilation. The indoor air quality may deteriorate if the air conditioner is used for long durations.
- Clean the air filter once every 2 weeks. Dust and impurities collected in the air filter may block the air flow or reduce the unit performance.

Parts and Functions

Indoor Unit

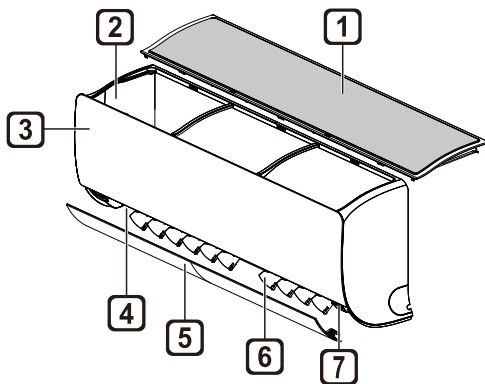

- 1 Air Filter
- 2 Air Intake
- 3 Front Cover
- 4 Air Outlet
- 5 Air Deflector (Horizontal Vane)
- 6 Air Deflector (Vertical Louver)
- 7 On/Off Button

Outdoor Unit

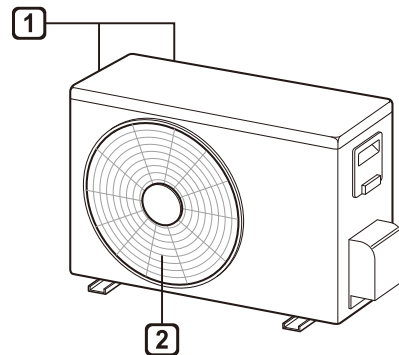

- 1 Air Intake Vents
- 2 Air Outlet Vents

NOTE

- The number and location of operation lamps may vary according to the model of the air conditioner.
- The feature may be changed according to the type of model.

Wireless Remote Control

Inserting Batteries

If the display screen of the remote control begins to fade, replace the batteries. Insert AAA (1.5 V) batteries before using the remote control.

- 1 Remove the battery cover.

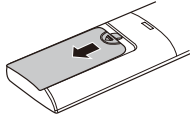

- 2 Insert the new batteries and make sure that the + and - terminals of the batteries are installed correctly.

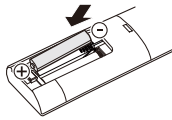

Installing the Remote Control Holder

To protect the remote control, install the holder where there is no direct sunlight.

- 1 Choose a safe and easily accessible location.
- 2 Fix the holder by fastening 2 screws firmly with a screwdriver.

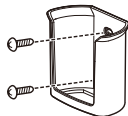

Operating Method

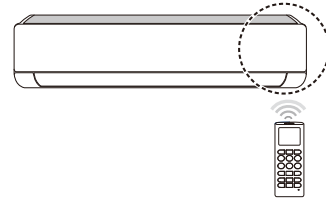

Point the remote control towards the signal receiver at the right side of the air conditioner to operate it.



NOTE

- The remote control may operate other electronic devices if it is directed towards them. Make sure to point the remote control towards the air conditioner signal receiver.
- For proper operation, use a soft cloth to clean the signal transmitter and receiver.
- In case of a function not provided in the product, no buzzer sound occurs from the product when a button for such function on the remote control is pressed except for Air Flow Direction (SWING), Energy Display (kW [3.5]), Air Purification function (AIR PUR).

Setting the Current Time

- 1 Insert batteries.
 - The icon below blinks at the bottom of the display screen.
- 
- 2 Press  or  button to select the minutes.
 - 3 Press **SET/CANCEL** button to finish.

NOTE

- The On/Off Timer is available after setting the current time.

Using the °C/°F Conversion Function (Optional)

This function changes unit between °C and °F

- Press and hold  button about 5 seconds.

Operating the Air Conditioner without the Remote Control

You can use the **ON/OFF** button of the indoor unit to operate the air conditioner when the remote control is unavailable.

- 1 Open the front cover (Type2) or horizontal vane (Type1).
- 2 Press the **ON/OFF** button.

Type1

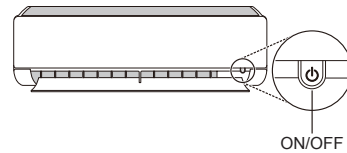

Type2

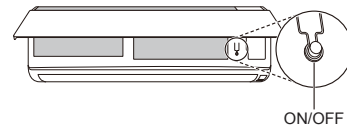

NOTE

- The stepping motor may be broken, if the horizontal vane opens rapidly.
- The fan speed is set to high.
- The feature may be changed according to the type of model.
- The temperature cannot be altered when using this emergency **ON/OFF** button.
- For cooling & heating models, the temperature is set from 22 °C to 24 °C

Using Wireless Remote Control

You can operate the air conditioner more conveniently with the remote control.

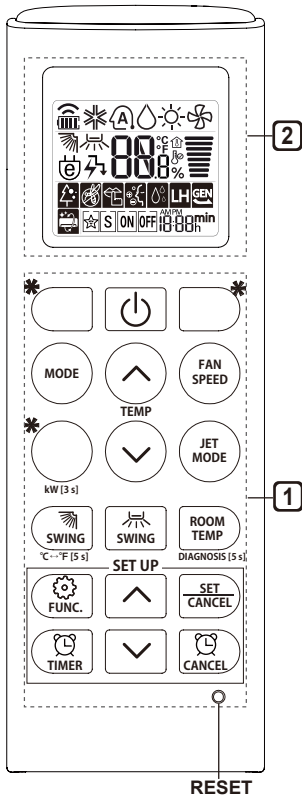

1 Button	2 Display Screen	Description	Available Function	
			Single Split	Multi
	-	To turn on/off the air conditioner.	○	○
	88°C	To adjust the desired room temperature in cooling, heating or auto changeover mode.	○	○
MODE		To select the cooling mode.	○	○
		To select the heating mode.	○	○
		To select the dehumidification mode.	○	○
		To select the fan mode.	○	○
		To select the auto changeover/auto operation mode.	○	○
JET MODE	Po	To change room temperature quickly.	○	○
FAN SPEED		To adjust the fan speed.	○	○
		To adjust the air flow direction vertically or horizontally.	○	○

NOTE



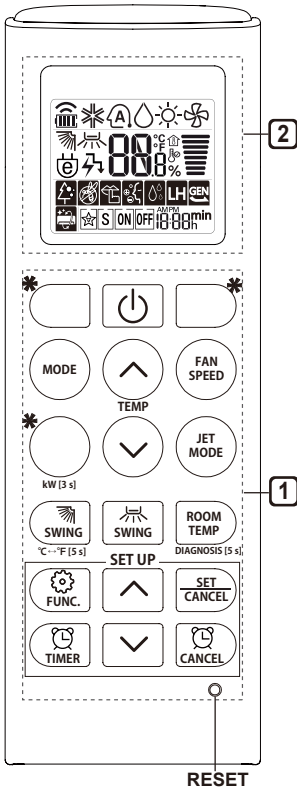



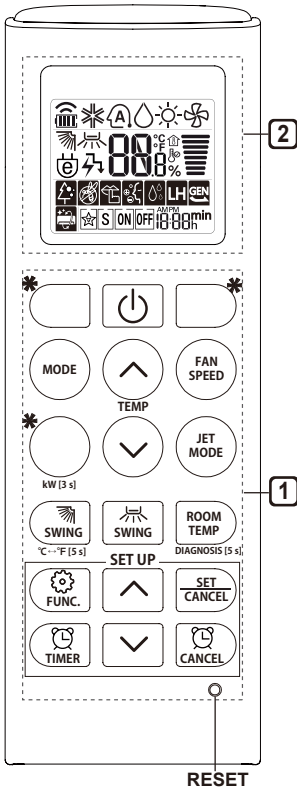

- * buttons may be changed according to the type of model.
- When connected to the Multi Outdoor unit, the Energy Display, Energy Control, Silent and Smart Diagnosis function may not be supported.



1 Button	2 Display Screen	Description	Available Function	
			Single Split	Multi
	S 	To turn on/off air conditioner automatically at desired time.	○	○
SET/ CANCEL	-	To set/cancel the special functions and timer.	○	○
	-	To cancel the timer settings.	○	○
	-	To adjust time.	○	○
*LIGHT OFF	-	To set the brightness of the display on the indoor unit.	○	○
ROOM TEMP		To display the room temperature.	○	○
°C↔°F [5 s]		To change unit between °C and °F	○	○
*ENERGY SAVING		To minimize power consumption.	○	○
*COMFORT AIR		To adjust the air flow to deflect wind.	○	○
kW [3 s]	-	To set whether or not to display information regarding energy.	○	X
*ENERGY CTRL	00 %	To bring the effect of the power saving.	X	X
*COMFORT SLEEP		To make a comfortable sleeping environment.	○	X
DIAGNOSIS [5 s]	-	To conveniently check maintenance information of a product.	○	○

RESET



1 Button	2 Display Screen	Description	Available Function	
			Single Split	Multi
		The Ion generator uses millions of ions to help improve indoor air quality.	X	X
		To reduce noise from outdoor units.	X	X
		To keep your skin moisturized by generating ion clusters.	X	X
		To lower indoor humidity quickly.	X	X
		To maintain a minimum room temperature and prevent objects in the room from freezing.	O (Optional)	X
		To scare away a mosquito.	X	X
		To remove moisture generated inside the indoor unit.	O	O
		To make a comfortable sleeping environment.	X	X
RESET	-	To initialize the remote control settings.	O	O

NOTE

- Some functions may not be supported, depending on the model.
- * buttons may be changed according to the type of model.
- Press the **SET/CANCEL** button to operate the selected **FUNC.**

Restarting the Air Conditioner Automatically

When the air conditioner is turned on again after a power failure, this function restores the previous settings.

Disabling Auto Restart

- 1 Open the front cover (Type2) or horizontal vane (Type1).
- 2 Press the **ON/OFF** button and hold it for 6 seconds, then the unit will beep twice and the lamp will blink twice 4 times.
 - To re-enable the function, press the **ON/OFF** button and hold it for 6 seconds. The unit will beep twice and the lamp will blink 4 times.

Type1

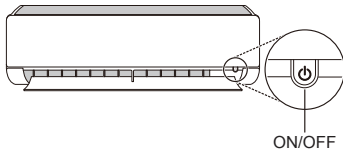

Type2

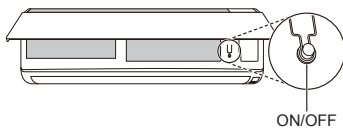

NOTE

- The feature may be changed according to the type of model.
- If you press and hold the **ON/OFF** button for 3 – 5 seconds, instead of 6 seconds, the unit will switch to the test operation. In the test operation, the unit blows out strong cooling air for 18 minutes and then returns to factory default settings.

Using the Mode Function

This function allows you to select the desired function.

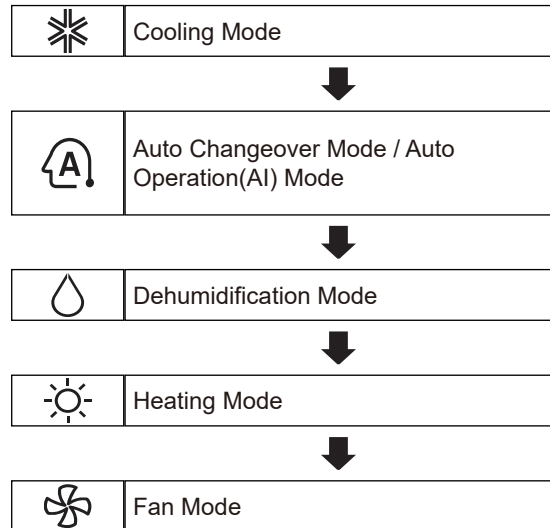



Cooling Mode

- 1 Turn the appliance on.
- 2 Press **MODE** button repeatedly to select the Cooling Mode.
 - ❄️ is displayed on the display screen.
- 3 Press \uparrow or \downarrow button to set the desired temperature.

Auto Operation (Artificial Intelligence)

Multi Model



In this operation mode, the system is automatically operated by the electronic controls.

- 1 Turn the appliance on.
- 2 Press **MODE** button repeatedly to select the Auto Operation.
 -  is displayed on the display screen.
- 3 Press  or  button to set the desired temperature.
- 4 Press **FAN SPEED** button to adjust the fan speed.

Auto Changeover Mode

Single Split Model

This mode changes the mode automatically to maintain the set temperature at ± 2 °C

- 1 Turn the appliance on.
- 2 Press **MODE** button repeatedly to select the Auto Changeover Mode.
 -  is displayed on the display screen.
- 3 Press  or  button to set the desired temperature.
- 4 Press **FAN SPEED** button to adjust the fan speed.

Dehumidification Mode



This mode removes excess moisture from a highly humid environment or during the rainy season, in order to prevent mildew from setting in. This mode adjusts the room temperature and the fan speed automatically to maintain the optimal level of humidity.

- 1 Turn the appliance on.
- 2 Press **MODE** button repeatedly to select the Dehumidification Mode.
 -  is displayed on the display screen.

NOTE

- In this mode you cannot adjust the room temperature, it is adjusted automatically.
- The room temperature is not displayed on the display screen.
- In the dehumidification mode, compressor and indoor fan may not operate when the room temperature is below 24 °C

Heating Mode

- 1 Turn the appliance on.
- 2 Press **MODE** button repeatedly to select the Heating Mode.
 -  is displayed on the display screen.
- 3 Press  or  button to set the desired temperature.

NOTE

-  will be displayed on the indoor unit when defrosting is operating.
- Furthermore, this indication will be displayed on the indoor unit:
 - When preheating is operating.
 - When the room temperature has been reached to the set temperature.

Fan Mode

This mode only circulates the indoor air without changing the room temperature.

- 1 Turn the appliance on.
- 2 Press **MODE** button repeatedly to select the Fan Mode.
 -  is displayed on the display screen.
- 3 Press **FAN SPEED** button to adjust the fan speed.

Using the Jet Mode Function





Changing Room Temperature Quickly

This function allows you to cool indoor air quickly during the summer or warm it quickly during winter.

- The Jet Mode function is available with Cooling, Heating and Dehumidification Mode.

- 1 Turn the appliance on.
- 2 Press **MODE** button repeatedly to select the desired mode.
- 3 Press **JET MODE** button.
 -  is displayed on the display screen.





NOTE

- Jet Heating Mode is not available on some models.
- In Jet Cooling Mode, strong air blows out for 30 minutes.
 - After 30 minutes later, setting temperature is maintaining 18 °C
If you want to change the temperature, Press  or  button to set the desired temperature.
- In Jet Heating Mode, strong air blows out for 30 minutes.
 - After 30 minutes later, setting temperature is maintaining 30 °C
If you want to change the temperature, Press  or  button to set the desired temperature.
- This function may operate differently from the remote control display.

Using the Fan Speed Function

Adjusting the Fan Speed

- Press **FAN SPEED** button repeatedly to adjust the fan speed.

Display Screen	Speed
	High
	Medium - High
	Medium
	Medium - Low
	Low
-	Natural Wind

NOTE

- The fan speed of Natural Wind adjusts automatically.





- The fan speed icons are displayed on some indoor units.

F1 → F2 → F3 → F4 → F5



- Indoor unit display is displayed only 5 seconds and return to the setting temperature on some models.

Using the Air Flow Direction Function

This function adjusts the direction of the air flow vertically (horizontally).

- Press   button repeatedly and select the desired direction.
 - Select  to adjust the direction of the air flow automatically.

NOTE

- Adjusting the air flow direction horizontally may not be supported, depending on the model.
- Adjusting the air deflector arbitrarily may cause product failure.
- If you restart the air conditioner, it starts to operate with the previously set direction of air flow, so the air deflector may not match the icon displayed on the remote control. When this occurs, press  or  button to adjust the direction of the air flow again.
- This function may operate differently from the remote control display.

Setting the On/Off Timer



This function sets the air conditioner to turn on/off automatically at desired time.

On/Off Timer can be set together.

Setting the On Timer

- 1 Press  button repeatedly.
 - The icon below blinks at the bottom of the display screen.



- 2 Press  or  button to select the minutes.
- 3 Press **SET/CANCEL** button to finish.
 - After setting the timer, current time and  icon are displayed on the display screen indicating that the desired time is set.

Canceling the On Timer

- 1 Press  button repeatedly.
 - The icon below blinks at the bottom of the display screen.





- 2 Press **SET/CANCEL** button to cancel the setting.

Setting the Off Timer

- 1 Press  button repeatedly.
 - The icon below blinks at the bottom of the display screen.



- 2 Press  or  button to select the minutes.
- 3 Press **SET/CANCEL** button to finish.
 - After setting the timer, current time and  icon are displayed on the display screen indicating that the desired time is set.

NOTE

- This function is disabled when you set Simple Timer.

Canceling the Off Timer

- 1 Press  button repeatedly.
 - The icon below blinks at the bottom of the display screen.



- 2 Press **SET/CANCEL** button to cancel the setting.

Canceling the Timer Setting



- Press  button to cancel all timer settings.

Using the Sleep Function (Optional)

This function turns off the air conditioner automatically when you go to sleep.

- 1 Turn the appliance on.
- 2 Press  button repeatedly.
 - The icon below blinks at the bottom of the display screen.



- 3 Press  or  button to select the hour (up to 7 hours).
- 4 Press **SET/CANCEL** button to finish.
 -  is displayed on the display screen.

NOTE



-  is displayed on some indoor units.
- Indoor unit display is displayed from 1H to 7H which is displayed only 5 seconds and then return to the setting temperature.
- In the Cooling and Dehumidification Mode, the temperature increases by 1 °C after 30 minutes and additional 1 °C after another 30 minutes for a more comfortable sleep.
- The temperature increases up to 2 °C from the preset temperature.
- Although the remark for fan speed on the display screen may be changed, the fan speed is adjusted automatically.

Using the Simple Timer Function (Optional)

This function turns off the air conditioner automatically when you go to sleep.

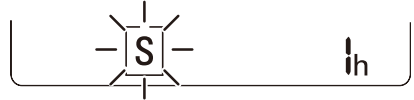
- 1 Turn the appliance on.
- 2 Press  button repeatedly.
 - The icon below blinks at the bottom of the display screen.



- 3 Press  or  button to select the hour (up to 7 hours).
- 4 Press **SET/CANCEL** button to finish.
 -  is displayed on the display screen.



NOTE

- This function is disabled when you set Off Timer.

Using the Energy Display Function (Optional)

This function displays the amount of electricity generated on the indoor display as the product operates.

Display the Current Energy Usage

- 1 Turn the appliance on.
- 2 Press  button and hold it about 3 seconds.
 - The instantaneous power consumption () is displayed for a while on some indoor units.

NOTE

- It is not displayed on the wireless remote control.
- The unit of the displayed value is kW.
- If it is more than 99 kW, which is the range of expression, maintain it as 99 kW.
- Display wattage under 10 kW with 0.1 kW unit, and display one over 10 kW with 1 kW unit.
- The actual power may differ from the power displayed.
- When connected to the Multi Outdoor unit, this function may not be supported.

Using the Light Off Function (Optional)

Display Screen Brightness

You can set the brightness of the indoor unit display screen.

- Press **LIGHT OFF** button.



NOTE

- Turn on/off the Display screen.



Using the Comfort Air Function (Optional)

Comfort Vane Operation

This function conveniently sets the vane to a preset position to deflect the supply air away from blowing directly onto the occupants in the room.

- 1 Turn the appliance on.
- 2 Press **COMFORT AIR** button repeatedly and select the desired direction.
 -  or  is displayed on the display screen.

NOTE

-  or  is displayed on some indoor units.
- This function is disabled when you press **MODE** or **JET MODE** button.
- This function is disabled and auto swing of vertical direction is set up when you press  button.
- When this function is off, the horizontal vane operates automatically depending on the set mode.

Using the Energy Saving Function (Optional)







This function minimizes power consumption during Cooling and increases the set temperature to the optimal level for a more comfortable environment. The temperature automatically settles at 22 °C if desired temperature is below 22 °C. The temperature remains constant if it is above 22 °C.

- 1 Turn the appliance on.
- 2 Press **MODE** button repeatedly to select the Cooling Mode.
- 3 Press **ENERGY SAVING** button.
 -  is displayed on the display screen.

Using the Energy Control Function (Optional)

- 1 Turn the appliance on.
- 2 Press **ENERGY CTRL** button.
 - Press **ENERGY CTRL** button repeatedly to select each step.

NOTE

- 1 step : The power Input is decreased by 20 % compared to rated power input.
 -  % is displayed on the display screen.
- 2 step : The power Input is decreased by 40 % compared to rated power input.
 -  % is displayed on the display screen.
- 3 step (Optional) : The power Input is decreased by 60 % compared to rated power input.
 -  % is displayed on the display screen.
-  (1 step),  (2 step) is displayed on some indoor units.
- This function is available with Cooling Mode.
- Capacity may decrease when Energy Control mode is selected.
- Desired temperature is displayed about 5 seconds if you press **FAN SPEED**,  or  button.
- Room temperature is displayed about 5 seconds if you press **ROOM TEMP** button.

Using Special Functions

- 1 Turn the appliance on.
- 2 Press **FUNC** button repeatedly to select the desired function.
- 3 Press **SET/CANCEL** button to finish.



Display Screen	Description	Available Function	
		Single Split	Multi
	The Ion generator uses millions of ions to help improve indoor air quality.	X	X
	To reduce noise from outdoor units.	X	X
	To keep your skin moisturized by generating ion clusters.	X	X
	To lower indoor humidity quickly.	X	X
	To maintain a minimum room temperature and prevent objects in the room from freezing.	O (Optional)	X
	To scare away a mosquito.	X	X
	To remove moisture generated inside the indoor unit.	O	O
	To make a comfortable sleeping environment.	X	X

NOTE

- Some functions may not be supported, depending on the model.
- Some functions may operate differently from the remote control display.

Canceling Special Functions

- 1 Press **FUNC** button repeatedly to select the desired function.
- 2 Press **SET/CANCEL** button to cancel the function.

Using the Air Purification Function

These functions supply clean and fresh air by ion particles and the filter.

Function	Display	Description
Ionizer		Ion particles from ionizer reduce the surface bacteria and other harmful substances.
Plasma		It removes microscopic contaminants from the intake air completely to supply clean and fresh air.

NOTE

- You can use this function without turning the air conditioner on.
- Both the plasma lamp and the cooling lamp light up while Smoke Away/Plasma is in operation on some models.
- Do not touch ionizer during operation.
- This function may operate differently from the remote control display.

Using the Silent Function (Optional)

This function prevents potential claims by neighbors, reducing noise from outdoor units.

-  is displayed on the display screen.

NOTE

- This function is disabled when you press **MODE** or **ENERGY CTRL** or **JET MODE** button.
- This function is available with Cooling, Heating, Auto Changeover, Auto Operation Mode.

Using the Ion Care Function (Optional)

This function keeps your skin moisturized by generating ion clusters which is absorbed into the surface of skin.

-  is displayed on the display screen about 3 seconds.

NOTE

- This function is available with Cooling, Fan Mode and Air Purification function.

Using the Jet Dry Function (Optional)

This function maximizes the performance of dehumidification.

-   are displayed on the display screen.

NOTE



- This function is available with Cooling, Dehumidification, Auto Operation, Fan Mode and Air Purification function.
- This function is not available with Sleep function.
- This function is disabled when you press **MODE** button.

Using the Low Heating Function (Optional)

This function operates the heating system to maintain a minimum room temperature and prevent objects in the room from freezing where there is no permanent resident, such as a vacation.

-  LH are displayed on the display screen.

NOTE

- This function is available with Heating Mode.
- During LH operation, when you press buttons such as , , **MODE**, **FAN SPEED**, and then return to Heating Mode.
- If **JET MODE** button is pressed during LH operation, this function is disabled and Power Heating Mode is operated immediately. (only for power heating model)
- In case an error occurred, operation can be interrupted for the protection of the product.
- **COMFORT AIR** and  button cannot be used while the LH function is in operation.

Using the Mosquito Away Function (Optional)

This function fans away mosquitos by generating a high-frequency wave.

-  is displayed on the display screen.

NOTE

- You can use this function without turning the air conditioner on.
-  is displayed on some indoor units.

Using the Auto Clean Function

In the Cooling and Dehumidification Mode, moisture is generated inside the indoor unit. This function removes such moisture.

-  is displayed on the display screen.

NOTE

- Some functions cannot be used while the Auto Clean function is in operation.
- If you turn off the unit, the fan continues to run for 30 minutes and cleans the inside of the indoor unit.
-  is displayed on some indoor units, depending on the model.

Using the Comfort Sleep Function (Optional)

This function operates the air conditioner automatically to make the comfortable sleep environment.

- , SL are displayed on the display screen.

NOTE

- This function is available with Cooling Mode.
- The vane stops swing and sets indirect airflow angle, after 30 minutes from start even though the room temperature doesn't decrease to optimal temperature to sleep.
- It is possible that a comfortable sleep environment is different according to the people.

SMART FUNCTIONS

LG ThinQ Application

This feature is only available on models with the  or **ThinQ** logo.

The **LG ThinQ** application allows you to communicate with the appliance using a smartphone.

LG ThinQ Application Features

Communicate with the appliance from a smartphone using the convenient smart features.

Smart Diagnosis™

If you experience a problem while using the appliance, this smart diagnosis feature will help you diagnose the problem.

Settings

Allows you to set various options on the appliance and in the application.

NOTE

- If you change your wireless router, internet service provider, or password, delete the registered appliance from the **LG ThinQ** application and register it again.
- The application is subject to change for appliance improvement purposes without notice to users.
- Functions may vary by model.

Before Using LG ThinQ Application

- 1 Check the distance between the appliance and the wireless router (Wi-Fi network).
 - If the distance between the appliance and the wireless router is too far, the signal strength becomes weak. It may take a long time to register or installation may fail.

- 2 Turn off the **Mobile data** or **Cellular Data** on your smartphone.

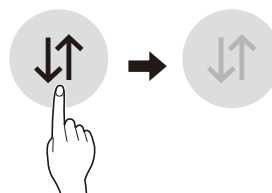

- 3 Connect your smartphone to the wireless router.

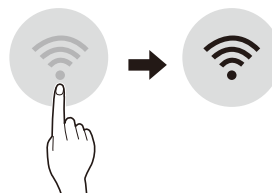

NOTE

- To verify the Wi-Fi connection, check that  icon on the control panel is lit.
- The appliance supports 2.4 GHz Wi-Fi networks only. To check your network frequency, contact your Internet service provider or refer to your wireless router manual.
- **LG ThinQ** is not responsible for any network connection problems or any faults, malfunctions, or errors caused by network connection.
- If the appliance is having trouble connecting to the Wi-Fi network, it may be too far from the router. Purchase a Wi-Fi repeater (range extender) to improve the Wi-Fi signal strength.
- The Wi-Fi connection may not connect or may be interrupted because of the home network environment.
- The network connection may not work properly depending on the Internet service provider.
- The surrounding wireless environment can make the wireless network service run slowly.

- The appliance cannot be registered due to problems with the wireless signal transmission. Unplug the appliance and wait about a minute before trying again.
- If the firewall on your wireless router is enabled, disable the firewall or add an exception to it.
- The wireless network name (SSID) should be a combination of English letters and numbers. (Do not use special characters.)
- Smartphone user interface (UI) may vary depending on the mobile operating system (OS) and the manufacturer.
- If the security protocol of the router is set to **WEP**, you may fail to set up the network. Please change it to other security protocols (**WPA2** is recommended) and register the product again.

Installing the LG ThinQ Application

Search for the **LG ThinQ** application from the Google Play Store or Apple App Store on a smartphone. Follow instructions to download and install the application.



Open Source Software Notice Information

To obtain the source code under GPL, LGPL, MPL, and other open source licenses, that is contained in this product, please visit <https://opensource.lge.com>.

In addition to the source code, all referred license terms, warranty disclaimers and copyright notices are available for download.

LG Electronics will also provide open source code to you on CD-ROM for a charge covering the cost of performing such distribution (such as the cost of media, shipping, and handling) upon email request to opensource@lge.com. This offer is valid for a period of three years after our last shipment of this product. This offer is valid to anyone in receipt of this information.

Smart Diagnosis™

This feature is only available on models with the  or  logo.

Use this feature to help you diagnose and solve problems with your appliance.

NOTE

- For reasons not attributable to LGE's negligence, the service may not operate due to external factors such as, but not limited to, Wi-Fi unavailability, Wi-Fi disconnection, local app store policy, or app unavailability.
- The feature may be subject to change without prior notice and may have a different form depending on where you are located.

Using LG ThinQ to Diagnose Issues



If you experience a problem with your Wi-Fi equipped appliance, it can transmit troubleshooting data to a smartphone using the **LG ThinQ** application.

- Launch the **LG ThinQ** application and select the **Smart Diagnosis™** feature in the menu. Follow the instructions provided in the **LG ThinQ** application.

Using Audible Diagnosis to Diagnose Issues

Follow the instructions below to use the audible diagnosis method.

- Launch the **LG ThinQ** application and select the **Smart Diagnosis™** feature in the menu. Follow the instructions for audible diagnosis provided in the **LG ThinQ** application.

- 1 Plug the power plug in the outlet properly.
- 2 Place the mouthpiece of your smartphone close to the  or  logo.
- 3 Press and hold the **DIAGNOSIS [5 s]** button for 5 seconds or longer while holding the smartphone mouthpiece to the logo until the data transfer is complete.
 - Keep the smartphone in place until the data transfer has finished. Time remaining for data transfer is displayed.
- 4 After the data transfer is complete, the diagnosis will be displayed in the application.

NOTE

- For best results, do not move the phone while the tones are being transmitted.
- Be sure to keep ambient noise to a minimum or the phone may not correctly receive the buzzer beeps from the indoor unit.

MAINTENANCE

⚠ WARNING

- Before cleaning or performing maintenance, disconnect the power supply and wait until the fan stops.

If the air conditioner will not be used for an extended period of time, dry the air conditioner to maintain it in best condition. Clean the product regularly to maintain optimal performance and to prevent possible breakdown.

- Dry the air conditioner in Fan mode for 3 to 4 hours and disconnect the power. There may be internal damage if moisture is left in its components.
- Before using the air conditioner again, dry the inner components of the air conditioner in Fan mode for 3 to 4 hours. This will help to remove the odor generated from moisture.

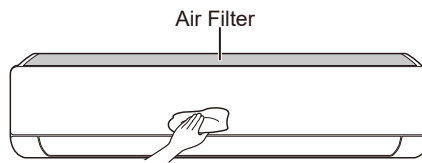

- The feature may be changed according to the type of model.

Type	Description	Interval
Air filter	Clean with a vacuum or hand wash.	2 weeks
Triple filter	Clean with a vacuum or brush.	Every 3 months
Micro dust filter	Clean with a vacuum or brush.	Once a month
Ionizer (Optional)	Use dry cotton bud to remove any dust.	Every 6 months
Indoor unit	Clean the Indoor unit surface by using a soft, dry cloth.	Regularly
	Have a professional clean the condensate drain pan.	Once a year
	Have a professional clean the condensate drain pipe.	Every 4 months
	Replace the remote control batteries.	Once a year
Outdoor unit	Have a professional clean the heat exchanger coils and the panel vents. (Consult with technician.)	Once a year
	Have a professional clean the fan.	Once a year
	Have a professional clean the condensate drain pan.	Once a year
	Have a professional verify that all the fan assembly is firmly tightened.	Once a year
	Clean the electric components with air.	Once a year

NOTE

- Never use water that is higher than 40 °C when you clean the filters. It may cause deformation or discoloration.
- Never use volatile substances when you clean the filters. They may damage the surface of the product.
- Do not wash the Micro dust filter with water, because the filter can be damaged (Optional).
- Do not wash the Triple filter with water, because the filter can be damaged (Optional).

Clean the Air Filter

Clean the air filters once every 2 weeks, or more, if necessary.

NOTE

- The air filter can be broken when it is bent.
- When the air filter is not assembled correctly, dust and other substances can enter into the indoor unit.

Type1

If you look at the indoor unit from above it, can assemble the top filter easily.

- 1 Turn off the power to the unit.
- 2 Hold the knobs of the air filter, lift it up slightly.

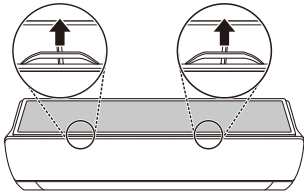

- 3 Remove it from the indoor unit.

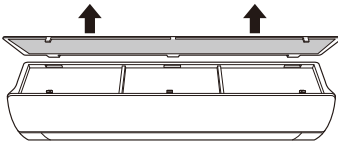

- 4 Clean the filter with a vacuum cleaner or with lukewarm water with neutral detergent.
- 5 Dry the filter in the shade.
- 6 Insert the hooks of the air filter into the front cover.

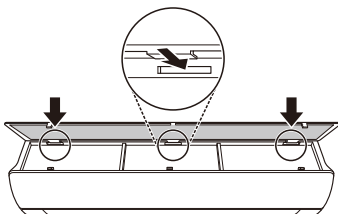

- 7 Push down hooks to assemble the air filter.

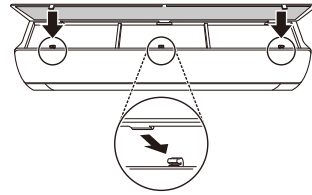

- 8 Check the side of the front cover for correct assembly of the air filter.

Type2

- 1 Turn off the power to the unit.
- 2 Open the front cover.
 - Lift up both sides of the cover slightly.
- 3 Hold the knobs of the air filters, pull them down slightly and remove them from the indoor unit.

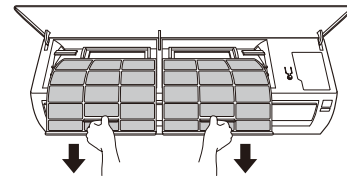

- 4 Clean the filters with a vacuum cleaner or with lukewarm water with neutral detergent.
- 5 Dry the filters in the shade.
- 6 Insert the hooks of the air filters into the front cover.

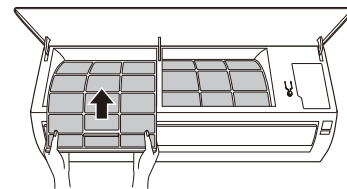

- 7 Check the side of the front cover for correct assembly of the air filters.

Clean the Micro Dust and Triple Filter (Optional)

- 1 Turn off the power to the unit.
- 2 Remove the air filters from the indoor unit.
- 3 Remove the Micro dust and Triple filter from the indoor unit.

Type1

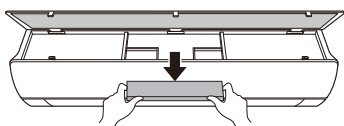

Type2

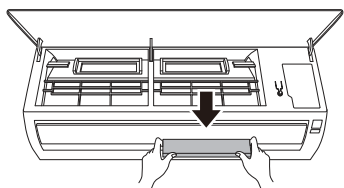

- 4 Clean the filter with a vacuum cleaner.

- 5 Insert the Micro dust and Triple filter.

Type1

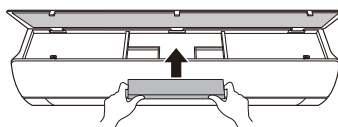

Type2

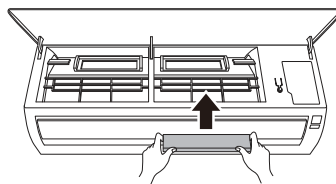

- 6 Assemble the air filters.
- 7 Check the side of the front cover for correct assembly of the air filters.

NOTE

- The feature and location of Micro dust and Triple filter may vary according to the type of model.

TROUBLESHOOTING

Self-diagnosis Function

This product has a built-in self-diagnosis function. If an error occurs, the lamp of the indoor unit will blink in 2 second intervals. If this occurs, contact your local dealer or service center.

Before Calling for Service

Please check the following before you contact the service center. If the problem persists, contact your local service center.

Symptoms	Possible Causes & Solution
The air conditioner does not work normally.	Burning smell and strange sounds are coming from the unit. <ul style="list-style-type: none"> Turn off the air conditioner, switch OFF, or disconnect the power supply, and contact the service center.
	Water leaks from the indoor unit even when the humidity level is low. <ul style="list-style-type: none"> Turn off the air conditioner, switch OFF, or disconnect the power supply, and contact the service center.
	The power cable is damaged or it is generating excessive heat. <ul style="list-style-type: none"> Turn off the air conditioner, switch OFF, or disconnect the power supply, and contact the service center.
	A switch, a circuit breaker (safety, ground), or a fuse is not operated properly. <ul style="list-style-type: none"> Turn off the air conditioner, switch OFF, or disconnect the power supply, and contact the service center.
	The unit generates an error code from its self-diagnosis. <ul style="list-style-type: none"> Turn off the air conditioner, switch OFF, or disconnect the power supply, and contact the service center.
The air conditioner does not work.	The air conditioner is unplugged. <ul style="list-style-type: none"> Check whether the power cord is plugged into the outlet or the power isolators are switched on.
	A fuse exploded, or the power supply is blocked. <ul style="list-style-type: none"> Replace the fuse or check if the circuit breaker has tripped.
	A power failure has occurred. <ul style="list-style-type: none"> Turn off the air conditioner when a power failure occurs. When the power is restored, wait 3 minutes, and then turn on the air conditioner.
	The voltage is too high or too low. <ul style="list-style-type: none"> Check if the circuit breaker has tripped.
	The air conditioner was turned off automatically at a preset time. <ul style="list-style-type: none"> Turn the air conditioner on.
	The battery setting in the remote controller is incorrect. <ul style="list-style-type: none"> Make sure that the batteries are inserted correctly in your remote controller. If the batteries are placed correctly, but the air conditioner still does not operate, replace the batteries and try again.

Symptoms	Possible Causes & Solution
<p>The air conditioner does not emit cool air.</p>	<p>Air is not circulating properly.</p> <ul style="list-style-type: none"> • Make sure that there are no curtains, blinds, or pieces of furniture blocking the front of the air conditioner.
	<p>The air filter is dirty.</p> <ul style="list-style-type: none"> • Clean the air filter once every 2 weeks. • See “Clean the Air Filter” for more information.
	<p>The room temperature is too high.</p> <ul style="list-style-type: none"> • In summer, cooling the indoor air fully may take some time. In this case, select the Jet Mode to cool the indoor air quickly.
	<p>Cold air is escaping from the room.</p> <ul style="list-style-type: none"> • Make sure that no cold air is escaping through the ventilation points in the room.
	<p>The desired temperature is higher than the current temperature.</p> <ul style="list-style-type: none"> • Set the desired temperature to a level lower than the current temperature.
	<p>There is a heating source nearby.</p> <ul style="list-style-type: none"> • Avoid using heat generators like electric ovens or gas burners while the air conditioner is in operation.
	<p>Fan Mode is selected.</p> <ul style="list-style-type: none"> • During Fan Mode, air blows from the air conditioner without cooling or heating the indoor air. • Switch the operation mode to cooling operation.
	<p>Outside temperature is too high.</p> <ul style="list-style-type: none"> • The cooling effect may not be sufficient.
<p>The fan speed cannot be adjusted.</p>	<p>The Jet Mode, or Auto Operation Mode is selected.</p> <ul style="list-style-type: none"> • In some operation modes, you cannot adjust the fan speed. Select an operation mode in which you can adjust the fan speed.
<p>The temperature cannot be adjusted.</p>	<p>The Fan Mode or Jet Mode is selected.</p> <ul style="list-style-type: none"> • In some operation modes, you cannot adjust the temperature. Select an operation mode in which you can adjust the temperature.
<p>The air conditioner stops during operation.</p>	<p>The air conditioner is suddenly turned off.</p> <ul style="list-style-type: none"> • The Timer Function may have timed out, which turns the unit off. Check the timer settings.
	<p>A power failure has occurred during operation.</p> <ul style="list-style-type: none"> • Wait for the power to come back. If you have the Auto Restart function enabled, your unit will resume its last operation several minutes after power is restored.

Symptoms	Possible Causes & Solution
The indoor unit is still operating even when the unit has been turned off.	<p>The Auto Clean function is being operated.</p> <ul style="list-style-type: none"> • Allow the Auto Clean function to continue since it removes any remaining moisture inside the indoor unit. If you do not want this feature, you can turn the unit off.
The air outlet on the indoor unit is discharging mist.	<p>The cooled air from the air conditioner makes mist.</p> <ul style="list-style-type: none"> • When the room temperature decreases, this phenomenon will disappear.
Water leaks from the outdoor unit.	<p>In the heating operations, condensed water drops from the heat exchanger.</p> <ul style="list-style-type: none"> • This symptom requires installing a drain hose under the base pan. Contact the installer.
There is noise or vibration.	<p>A clicking sound can be heard when the unit starts or stops due to movement of the reversing valve.</p> <p>Creaking sound: The plastic parts of the indoor unit creak when they shrink or expand due to sudden temperature changes.</p> <p>Flowing or Blowing sound: This is the flow of refrigerant through the air conditioner.</p> <ul style="list-style-type: none"> • These are normal symptoms. The noise will stop.
The indoor unit gives off an odor.	<p>Odors (such as cigarette smoke) may be absorbed into the indoor unit and discharged with airflow.</p> <ul style="list-style-type: none"> • If the smell does not disappear, you need to wash the filter. If this does not work, contact the service center to clean your heat exchanger.
The air conditioner does not emit warm air.	<p>When Heating Mode starts, the vane is almost closed, and no air comes out, even though the outdoor unit is operating.</p> <ul style="list-style-type: none"> • This symptom is normal. Please wait until the unit has generated enough warm air to blow through the indoor unit.
	<p>The outdoor unit is in Defrosting Mode.</p> <ul style="list-style-type: none"> • In Heating Mode, ice/frost is built up on the coils when the outside temperature falls. This function removes a layer of frost on the coil, and it should finish in approximately 15 minutes.
	<p>Outside temperature is too low.</p> <ul style="list-style-type: none"> • The heating effect may not be sufficient.

Symptoms	Possible Causes & Solution
Your home appliance and smartphone is not connected to the Wi-Fi network.	The password for the Wi-Fi that you are trying to connect to is incorrect. <ul style="list-style-type: none"> Find the Wi-Fi network connected to your smartphone and remove it, then register your appliance on LG ThinQ.
	Mobile data for your smartphone is turned on. <ul style="list-style-type: none"> Turn off the Mobile data of your smartphone and register the appliance using the Wi-Fi network.
	The wireless network name (SSID) is set incorrectly. <ul style="list-style-type: none"> The wireless network name (SSID) should be a combination of English letters and numbers. (Do not use special characters.)
	The router frequency is not 2.4 GHz. <ul style="list-style-type: none"> Only a 2.4 GHz router frequency is supported. Set the wireless router to 2.4 GHz and connect the appliance to the wireless router. To check the router frequency, check with your Internet service provider or the router manufacturer.
	The distance between the appliance and the router is too far. <ul style="list-style-type: none"> If the distance between the appliance and the router is too far, the signal may be weak and the connection may not be configured correctly. Move the location of the router so that it is closer to the appliance.

NOTE

- Some functions may not be supported, depending on the model.

WARRANTY (USA)

ARBITRATION NOTICE: THIS LIMITED WARRANTY CONTAINS AN ARBITRATION PROVISION THAT REQUIRES YOU AND LG TO RESOLVE DISPUTES BY BINDING ARBITRATION INSTEAD OF IN COURT, UNLESS YOU CHOOSE TO OPT OUT. IN ARBITRATION, CLASS ACTIONS AND JURY TRIALS ARE NOT PERMITTED. PLEASE SEE THE SECTION TITLED "PROCEDURE FOR RESOLVING DISPUTES" BELOW.

PROCEDURE FOR RESOLVING DISPUTES:

ALL DISPUTES BETWEEN YOU AND LG ARISING OUT OF OR RELATING IN ANY WAY TO THIS LIMITED WARRANTY OR THE PRODUCT SHALL BE RESOLVED EXCLUSIVELY THROUGH BINDING ARBITRATION, AND NOT IN A COURT OF GENERAL JURISDICTION. BINDING ARBITRATION MEANS THAT YOU AND LG ARE EACH WAIVING THE RIGHT TO A JURY TRIAL AND TO BRING OR PARTICIPATE IN A CLASS ACTION.

Definitions. For the purposes of this section, references to "LG" mean LG Electronics U.S.A., Inc., its parents, subsidiaries and affiliates, and each of their officers, directors, employees, agents, beneficiaries, predecessors in interest, successors, assigns and suppliers; references to "dispute" or "claim" shall include any dispute, claim or controversy of any kind whatsoever (whether based in contract, tort, statute, regulation, ordinance, fraud, misrepresentation or any other legal or equitable theory) arising out of or relating in any way to the sale, condition or performance of the product or this Limited Warranty.

Notice of Dispute. In the event you intend to commence an arbitration proceeding, you must first notify LG in writing at least 30 days in advance of initiating the arbitration by sending a letter to LG at LG Electronics, USA, Inc. Attn: Legal Department- Arbitration 111 Sylvan Avenue, Englewood Cliffs, NJ 07632. You and LG agree to engage in good faith discussions in an attempt to amicably resolve your claim. The notice must provide your name, address, and telephone number; identify the product that is the subject of the claim; and describe the nature of the claim and the relief being sought. If you and LG are unable to resolve the dispute within 30 days, either party may proceed to file a claim for arbitration.

Agreement to Binding Arbitration and Class Action Waiver. Upon failure to resolve the dispute during the 30 day period after sending written notice to LG, you and LG agree to resolve any claims between us only by binding arbitration on an individual basis, unless you opt out as provided below. Any dispute between you and LG shall not be combined or consolidated with a dispute involving any other person's or entity's product or claim. More specifically, without limitation of the foregoing, any dispute between you and LG shall not under any circumstances proceed as part of a class or representative action. Instead of arbitration, either party may bring an individual action in small claims court, but that small claims court action may not be brought on a class or representative basis.

Arbitration Rules and Procedures. To begin arbitration of a claim, either you or LG must make a written demand for arbitration. The arbitration will be administered by the American Arbitration Association ("AAA") and will be conducted before a single arbitrator under the AAA's Consumer Arbitration Rules that are in effect at the time the arbitration is initiated (referred to as the "AAA Rules") and under the procedures set forth in this section. The AAA Rules are available online at www.adr.org/consumer. Send a copy of your written demand for arbitration, as well as a copy of this provision, to the AAA in the manner described in the AAA Rules. You must also send a copy of your written demand to LG at LG Electronics, USA, Inc. Attn: Legal Department- Arbitration 111 Sylvan Avenue, Englewood Cliffs, NJ 07632. If there is a conflict between the AAA Rules and the rules set forth in this section, the rules set forth in this section will govern. This arbitration provision is governed by the Federal Arbitration Act. Judgment may be entered on the arbitrator's award in any court of competent jurisdiction. All issues are for the arbitrator to decide, except that issues relating to the scope and enforceability of the arbitration provision and to the arbitrability of the dispute are for the court to decide. The arbitrator is bound by the terms of this provision.

Governing Law. The law of the state of your residence shall govern this Limited Warranty and any disputes between us except to the extent that such law is preempted by or inconsistent with applicable federal law.

Fees/Costs. You do not need to pay any fee to begin an arbitration. Upon receipt of your written demand for arbitration, LG will promptly pay all arbitration filing fees to the AAA unless you seek more than \$25,000 in damages, in which case the payment of these fees will be governed by the AAA Rules. Except as otherwise provided for herein, LG will pay all AAA filing, administration and arbitrator fees for any arbitration initiated in accordance with the AAA Rules and this arbitration provision. If you prevail in the arbitration, LG will pay your attorneys' fees and expenses as long as they are reasonable, by considering factors including, but not limited to, the purchase amount and claim amount. Notwithstanding the foregoing, if applicable law allows for an award of reasonable attorneys' fees and expenses, an arbitrator can award them to the same extent that a court would. If the arbitrator finds either the substance of your claim or the relief sought in the demand is frivolous or brought for an improper purpose (as measured by the standards set forth in Federal Rule of Civil Procedure 11(b)), then the payment of all arbitration fees will be governed by the AAA Rules. In such a situation, you agree to reimburse LG for all monies previously disbursed by it that are otherwise your obligation to pay under the AAA Rules. Except as otherwise provided for, LG waives any rights it may have to seek attorneys' fees and expenses from you if LG prevails in the arbitration.

Hearings and Location. If your claim is for \$25,000 or less, you may choose to have the arbitration conducted solely on the basis of (1) documents submitted to the arbitrator, (2) through a telephonic hearing, or (3) by an in-person hearing as established by the AAA Rules. If your claim exceeds \$25,000, the right to a hearing will be determined by the AAA Rules. Any in-person arbitration hearings will be held at a location within the federal judicial district in which you reside unless we both agree to another location or we agree to a telephonic arbitration.

Opt Out. You may opt out of this dispute resolution procedure. If you opt out, neither you nor LG can require the other to participate in an arbitration proceeding. To opt out, you must send notice to LG no later than 30 calendar days from the date of the first consumer purchaser's purchase of the product by either: (i) sending an e-mail to optout@lge.com, with the subject line: "Arbitration Opt Out" or (ii) calling 1-800-980-2973. You must include in the opt out e-mail or provide by telephone: (a) your name and address; (b) the date on which the product was purchased; (c) the product model name or model number; and (d) the serial number (the serial number can be found (i) on the product; or (ii) online by accessing <https://www.lg.com/us/support/repair-service/schedule-repair-continued> and clicking on "Find My Model & Serial Number").

You may only opt out of the dispute resolution procedure in the manner described above (that is, by e-mail or telephone); no other form of notice will be effective to opt out of this dispute resolution procedure. Opting out of this dispute resolution procedure will not affect the coverage of the Limited Warranty in any way, and you will continue to enjoy the full benefits of the Limited Warranty. If you keep this product and do not opt out, then you accept all terms and conditions of the arbitration provision described above.

WARRANTY (CANADA)

ARBITRATION NOTICE: THIS LIMITED WARRANTY CONTAINS AN ARBITRATION PROVISION THAT REQUIRES YOU AND LG TO RESOLVE DISPUTES BY BINDING ARBITRATION INSTEAD OF IN COURT, UNLESS THE LAWS OF YOUR PROVINCE OR TERRITORY DO NOT PERMIT THAT, OR, IN OTHER JURISDICTIONS, IF YOU CHOOSE TO OPT OUT. IN ARBITRATION, CLASS ACTIONS AND JURY TRIALS ARE NOT PERMITTED. PLEASE SEE THE SECTION TITLED “PROCEDURE FOR RESOLVING DISPUTES” BELOW.

PROCEDURE FOR RESOLVING DISPUTES:

EXCEPT WHERE PROHIBITED AT LAW, ALL DISPUTES BETWEEN YOU AND LG ARISING OUT OF OR RELATING IN ANY WAY TO THIS LIMITED WARRANTY OR THE PRODUCT SHALL BE RESOLVED EXCLUSIVELY THROUGH BINDING ARBITRATION, AND NOT IN A COURT OF GENERAL JURISDICTION. EXCEPT WHERE PROHIBITED AT LAW, YOU AND LG BOTH IRREVOCABLY AGREE TO WAIVE THE RIGHT TO A JURY TRIAL AND TO BRING OR PARTICIPATE IN A CLASS ACTION.

Definitions. For the purposes of this section, references to “LG” mean LG Electronics Canada, Inc., its parents, subsidiaries and affiliates, and each of their officers, directors, employees, agents, beneficiaries, predecessors in interest, successors, assigns and suppliers; references to “dispute” or “claim” shall include any dispute, claim or controversy of any kind whatsoever (whether based in contract, tort, statute, regulation, ordinance, fraud, misrepresentation or any other legal or equitable theory) arising out of or relating in any way to the sale, condition or performance of the product or this Limited Warranty.

Notice of Dispute. In the event you intend to commence an arbitration proceeding, you must first notify LG in writing at least 30 days in advance of initiating the arbitration by sending a letter to LGECI Legal Team at 20 Norelco Drive, North York, Ontario, Canada M9L 2X6 (the “Notice of Dispute”). You and LG agree to engage in good faith discussions in an attempt to amicably resolve your claim. The notice must provide your name, address, and telephone number; identify the product that is the subject of the claim; and describe the nature of the claim and the relief being sought. If you and LG are unable to resolve the dispute within 30 days of LG’s receipt of the Notice of Dispute, the dispute shall be resolved by binding arbitration in accordance with the procedure set out herein. You and LG both agree that, during the arbitration proceeding, the terms (including any amount) of any settlement offer made by either you or LG will not be disclosed to the arbitrator until the arbitrator determines the dispute.

Agreement to Binding Arbitration and Class Action Waiver. Upon failure to resolve the dispute during the 30 day period after LG’s receipt of the Notice of Dispute, you and LG agree to resolve any claims between you and LG only by binding arbitration on an individual basis, unless you opt out as provided below, or you reside in a jurisdiction that prevents full application of this clause in the circumstances of the claims at issue (in which case if you are a consumer, this clause will only apply if you expressly agree to the arbitration). To the extent permitted by applicable law, any dispute between you and LG shall not be combined or consolidated with a dispute involving any other person’s or entity’s product or claim. More specifically, without limitation of the foregoing, except to the extent such a prohibition is not permitted at law, any dispute between you and LG shall not under any circumstances proceed as part of a class or representative action. Instead of arbitration, either party may bring an individual action in small claims court, but that small claims court action may not be brought on a class or representative basis except to the extent this prohibition is not permitted at law in your province or territory of jurisdiction as it relates to the claims at issue between you and LG.

Arbitration Rules and Procedures. To begin arbitration of a claim, either you or LG must make a written demand for arbitration. The arbitration will be private and confidential, and conducted on a simplified and expedited basis before a single arbitrator chosen by the parties under the provincial or territorial commercial arbitration law and rules of the province or territory of your residence. You must also send a copy of your written demand to LG at LG Electronics, Canada, Inc., Attn: Legal Department- Arbitration, 20 Norelco Drive, North York, Ontario M9L 2X6. This arbitration provision is governed by your applicable provincial or territorial commercial arbitration legislation. Judgment may be entered on the arbitrator’s award in any court of competent jurisdiction. All issues are for the arbitrator to decide, except that, issues relating to the scope and enforceability of the arbitration provision and to the arbitrability of the dispute are for the court to decide. The arbitrator is bound by the terms of this provision.

Governing Law. The law of the province or territory of your purchase shall govern this Limited Warranty and any disputes between you and LG except to the extent that such law is preempted by or inconsistent with applicable federal or provincial/territorial law. Should arbitration not be permitted for any claim, action, dispute or controversy between you and LG, you and LG attorn to the exclusive jurisdiction of the courts of the province or territory of your purchase for the resolution of the claim, action, dispute or controversy between you and LG.

Fees/Costs. You do not need to pay any fee to begin an arbitration. Upon receipt of your written demand for arbitration, LG will promptly pay all arbitration filing fees unless you seek more than \$25,000 in damages, in which case the payment of these fees will be governed by the applicable arbitration rules. Except as otherwise provided for herein, LG will pay all filing, administration and arbitrator fees for any arbitration initiated in accordance with the applicable arbitration rules and this arbitration provision. If you prevail in the arbitration, LG will pay your attorneys' fees and expenses as long as they are reasonable, by considering factors including, but not limited to, the purchase amount and claim amount. Notwithstanding the foregoing, if applicable law allows for an award of reasonable attorneys' fees and expenses, an arbitrator can award them to the same extent that a court would. If the arbitrator finds either the substance of your claim or the relief sought in the demand is frivolous or brought for an improper purpose (as measured by the applicable laws), then the payment of all arbitration fees will be governed by the applicable arbitration rules. In such a situation, you agree to reimburse LG for all monies previously disbursed by it that are otherwise your obligation to pay under the applicable arbitration rules. Except as otherwise provided for, LG waives any rights it may have to seek attorneys' fees and expenses from you if LG prevails in the arbitration.

Hearings and Location. If your claim is for \$25,000 or less, you may choose to have the arbitration conducted solely (1) on the basis of documents submitted to the arbitrator, (2) through a telephonic hearing, or (3) by an in-person hearing as established by the applicable arbitration rules. If your claim exceeds \$25,000, the right to a hearing will be determined by the applicable arbitration rules. Any in-person arbitration hearings will be held at the nearest, most mutually-convenient arbitration location available within the province or territory in which you reside unless you and LG both agree to another location or agree to a telephonic arbitration.

Severability and Waiver. If any portion of this Limited Warranty (including these arbitration procedures) is unenforceable, the remaining provisions will continue in full force and effect to the maximum extent permitted by applicable law. Should LG fail to enforce strict performance of any provision of this Limited Warranty (including these arbitration procedures), it does not mean that LG intends to waive or has waived any provision or part of this Limited Warranty.

Opt Out. You may opt out of this dispute resolution procedure. If you opt out, neither you nor LG can require the other to participate in an arbitration proceeding. To opt out, you must send notice to LG no later than 30 calendar days from the date of the first consumer purchaser's purchase of the product by either (i) sending an e-mail to optout@lge.com, with the subject line: "Arbitration Opt Out;" or (ii) calling 1-800-980-2973. You must include in the opt out e-mail or provide by telephone: (a) your name and address; (b) the date on which the product was purchased; (c) the product model name or model number; and (d) the serial number (the serial number can be found (i) on the product; or (ii) online by accessing https://www.lg.com/ca_en/support/repair-service/schedule-repair and clicking on "Find My Model & Serial Number").

In the event that you "Opt Out", the law of the province or territory of your residence shall govern this Limited Warranty and any disputes between you and LG except to the extent that such law is preempted by or inconsistent with applicable federal or provincial/territorial law. Should arbitration not be permitted for any claim, action, dispute or controversy between you and LG, you and LG agree to attorn to the exclusive jurisdiction of the courts of the province or territory of your residence for the resolution of the claim, action, dispute or controversy between you and LG.

You may only opt out of the dispute resolution procedure in the manner described above (that is, by e-mail or telephone); no other form of notice will be effective to opt out of this dispute resolution procedure. Opting out of this dispute resolution procedure will not affect the coverage of the Limited Warranty in any way, and you will continue to enjoy the full benefits of the Limited Warranty. If you keep this product and do not opt out, then you accept all terms and conditions of the arbitration provision described above.

Conflict of Terms. In the event of a conflict or inconsistency between the terms of this Limited Warranty and the End User License Agreement ("EULA") in regards to dispute resolution, the terms of this Limited Warranty shall control and govern the rights and obligations of the parties and shall take precedence over the EULA.



US	Please call the installing contractor of your product, as warranty service will be provided by them.
CANADA	Service call Number # : (888) LG Canada, (888) 542-2623 Numéro pour les appels de service : LG Canada, 1-888-542-2623



OWNER'S MANUAL

AIR CONDITIONER



Read this owner's manual thoroughly before operating the appliance and keep it handy for reference at all times.

TYPE: WALL MOUNTED

ENGLISH



ENERGY STAR

If Indoor unit are connected with multi split type, It is not Energy Star certified products



MFL69491102
Rev.12_020521

www.lg.com

Copyright © 2017 - 2021 LG Electronics Inc. All Rights Reserved

TABLE OF CONTENTS

2 TABLE OF CONTENTS

3 SAFETY INSTRUCTIONS

3 IMPORTANT SAFETY INSTRUCTIONS

7 OPERATION

7 Notes for Operation
7 Parts and Functions
8 Wireless Remote Control
13 Restarting the Air Conditioner Automatically
13 Using the Mode Function
15 Using the Jet Mode Function
16 Using the Fan Speed Function
16 Using the Air Flow Direction Function
17 Setting the On/Off Timer
18 Using the Sleep Function (Optional)
18 Using the Simple Timer Function (Optional)
19 Using the Energy Display Function (Optional)
19 Using the Light Off Function (Optional)
19 Using the Comfort Air Function (Optional)
20 Using the Energy Saving Function (Optional)
20 Using the Energy Control Function (Optional)
21 Using Special Functions

24 SMART FUNCTIONS

24 LG ThinQ Application
26 Smart Diagnosis™

27 MAINTENANCE

29 Clean the Air Filter
30 Clean the Micro Dust and Triple Filter (Optional)

31 TROUBLESHOOTING

35 WARRANTY (USA)

37 WARRANTY (CANADA)

SAFETY INSTRUCTIONS

READ ALL INSTRUCTIONS BEFORE USE

Your safety and the safety of others are very important.

We have provided many important safety messages in this manual and on your appliance. Always read and follow all safety messages.

 This is the safety alert symbol.

This symbol alerts you to potential hazards that can kill or injure you and others.

All safety messages will follow the safety alert symbol and either the word **WARNING**, or **CAUTION**.

WARNING

If you do not follow instructions, it could result in death or serious injury.

CAUTION

If you do not follow instructions, it could result in minor or moderate injury or damage to the product.

All safety messages will tell you what the potential hazard is, tell you how to reduce the chance of injury, and tell you what may happen if the instructions are not followed.

IMPORTANT SAFETY INSTRUCTIONS

WARNING

To reduce the risk of explosion, fire, death, electric shock, injury or scalding to persons when using this product, follow basic precautions, including the following:

- Installation or repairs made by unauthorized persons can pose hazards to you and others.
- Installation **MUST** conform to the local building codes or, in the absence of local codes, the National Electrical Code NFPA 70/ANSI C1-1003 or current edition and Canadian Electrical Code Part1 CSA C.22. 1.
- The information contained in the manual is intended for use by a qualified service technician who is familiar with the safety procedures and equipped with the proper tools and test instruments.
- Failure to read and follow all instructions in this manual can result in equipment malfunction, property damage, personal injury and/or death.
- When the power cord is to be replaced, the replacement work shall be performed by authorized personnel using only genuine replacement parts.
- This appliance is not intended for use by persons (including children) with reduced physical, sensory or mental capabilities, or lack of experience and knowledge, unless they have been given supervision or instruction concerning use of the appliance by a person responsible for their safety. Children should be supervised to ensure that they do not play with the appliance.

Installation

- Do not install the air conditioner on an unstable surface or in a place where there is danger of it falling.
- Contact an authorized service center when installing or relocating the air conditioner.
- Install the panel and the cover of the control box safely.
- Do not install the air conditioner in a place where flammable liquids or gases such as gasoline, propane, paint thinner, etc., are stored.
- Make sure that the pipe and the power cable connecting the indoor and outdoor units are not pulled too tight when installing the air conditioner.
- Use standard circuit breaker and fuse that conform to the rating of the air conditioner.
- Do not input air or gas into the system except with the specific refrigerant.
- Use non-flammable gas (nitrogen) to check for leak and to purge air; using compressed air or flammable gas may cause fire or explosion.
- The indoor/outdoor wiring connections must be secured tightly, and the cable should be routed properly so that there is no force pulling the cable from the connection terminals. Improper or loose connections can cause heat generation or fire.
- Install dedicated electric outlet and circuit breaker before using the air conditioner.
- Do not connect the ground wire to a gas pipe, a lightning rod, or a telephone ground wire.
- If the supply cord is damaged, it must be replaced by the manufacturer, its service agent or similarly qualified person in order to avoid a hazard.
- Do not install the unit in potentially explosive atmospheres.

Operation

- Be sure to use only those parts listed in the service parts list. Never attempt to modify the equipment.
- Make sure that children do not climb on or hit the outdoor unit.
- Dispose of the batteries in a place where there is no danger of fire.
- Use only the refrigerant specified on the air conditioner label.
- Cut off the power supply if there is any noise, smell, or smoke coming from the air conditioner.
- Do not leave flammable substances such as gasoline, benzene, or thinner near the air conditioner.
- Contact an authorized service center when the air conditioner is submerged by flood waters.
- Do not use the air conditioner for an extended period of time in a small place without proper ventilation.
- In the event of a gas leak (such as Freon, propane gas, LP gas, etc.) ventilate sufficiently before using the air conditioner again.
- To clean the interior, contact an authorized service center or dealer. Using harsh detergents may cause corrosion or damage to the unit.

- Be sure to ventilate sufficiently when the air conditioner and a heating appliance such as a heater are used simultaneously.
- Do not block the inlet or outlet of air flow.
- Do not insert hands or other objects through the air inlet or outlet while the air conditioner is operating.
- Make sure that the power cable is neither dirty, loose, nor broken.
- Never touch, operate, or repair the air conditioner with wet hands.
- Do not place any objects on the power cable.
- Do not place a heater or other heating appliances near the power cable.
- Do not modify or extend the power cable. Scratches or peeling insulation on the power cables may result in fire or electric shock, and should be replaced.
- Cut off the power supply immediately in the event of a blackout or a thunderstorm.
- Take care to ensure that power cable could not be pulled out or damaged during operation.
- Do not touch refrigerant pipe, water pipe and any internal parts while the unit is operating or immediately after operation.

Maintenance

- Do not clean the appliance by spraying water directly onto the product.
- Before cleaning or performing maintenance, disconnect the power supply and wait until the fan stops.

CAUTION

To reduce the risk of minor injury to persons, malfunction, or damage to the product or property when using this product, follow basic precautions, including the following:

Installation

- Do not install the air conditioner in an area where it is directly exposed to sea wind (salt spray).
- Install the drain hose properly for the smooth drainage of water condensation.
- Exercise caution when unpacking or installing the air conditioner.
- Do not touch the leaking refrigerant during installation or repair.
- Transport the air conditioner with two or more people or use a forklift.
- Install the outdoor unit such that it is protected from direct sunlight. Do not place the indoor unit in a place where it is directly exposed to sunlight via the windows.
- Safely dispose of packing materials such as screws, nails, plastic bag or batteries using proper packaging after installation or repair.
- Install the air conditioner in a place where the noise from the outdoor unit or the exhaust fumes will not inconvenience the neighbors. Failure to do so may result in conflict with the neighbors.

Operation

- Remove the batteries if the remote control is not to be used for an extended period of time.
- Make sure that the filter is installed before operating the air conditioner.
- Be sure to check if there is a refrigerant leak after installing or repairing the air conditioner.
- Follow the standards of the corresponding region or country for handling the refrigerant and the air conditioner and for disassembling the air conditioner.
- Do not place any object on the air conditioner.
- Never mix different types of batteries, or old and new batteries for the remote control.
- Do not let the air conditioner run for a long time when humidity is very high or when a door or a window has been left open.
- Stop using the remote control if there is a fluid leak in the battery. If your clothes or skin are exposed to the leaking battery fluid, wash off with clean water.
- Do not expose people, animals, or plants to the cold or hot wind from the air conditioner for extended periods of time.
- If the leaking battery fluid has been swallowed, rinse the inside of the mouth thoroughly and consult a doctor.
- Do not drink the water drained from the air conditioner.
- Do not use the product for special purposes, such as preserving foods, works of art, and etc. It is an air conditioner for consumer purposes, not a precision refrigeration system. There is risk of damage or loss of property.
- Do not recharge or disassemble the batteries.

Maintenance

- Never touch the metal parts of the air conditioner when removing the air filter.
- Use a sturdy stool or ladder when cleaning, maintaining, or repairing the air conditioner at a height.
- Never use strong cleaning agents or solvents when cleaning the air conditioner or spray water. Use a smooth cloth.

OPERATION

Notes for Operation

Suggestion for Energy Saving

- Do not over-cool the space. This may be harmful for your health and may consume more electricity.
- Block sunlight with blinds or curtains while you are operating the air conditioner.
- Keep doors or windows closed tightly while you are operating the air conditioner.
- Adjust the direction of the air flow vertically or horizontally to circulate indoor air.
- Speed up the fan to cool or warm indoor air quickly, within a short period of time.
- Open windows regularly for ventilation. The indoor air quality may deteriorate if the air conditioner is used for long durations.
- Clean the air filter once every 2 weeks. Dust and impurities collected in the air filter may block the air flow or reduce the unit performance.

Parts and Functions

Indoor Unit

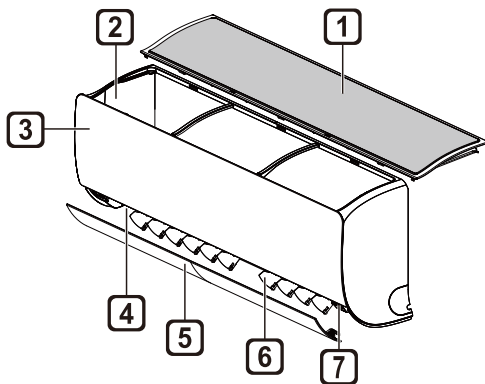

- 1 Air Filter
- 2 Air Intake
- 3 Front Cover
- 4 Air Outlet
- 5 Air Deflector (Horizontal Vane)
- 6 Air Deflector (Vertical Louver)
- 7 On/Off Button

Outdoor Unit

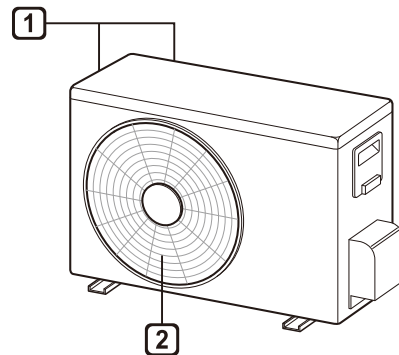

- 1 Air Intake Vents
- 2 Air Outlet Vents

NOTE

- The number and location of operation lamps may vary according to the model of the air conditioner.
- The feature may be changed according to the type of model.

Wireless Remote Control

Inserting Batteries

If the display screen of the remote control begins to fade, replace the batteries. Insert AAA (1.5 V) batteries before using the remote control.

- 1 Remove the battery cover.

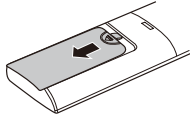

- 2 Insert the new batteries and make sure that the + and - terminals of the batteries are installed correctly.

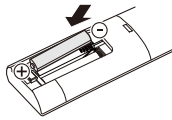

Installing the Remote Control Holder

To protect the remote control, install the holder where there is no direct sunlight.

- 1 Choose a safe and easily accessible location.
- 2 Fix the holder by fastening 2 screws firmly with a screwdriver.

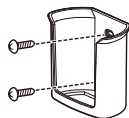

Operating Method

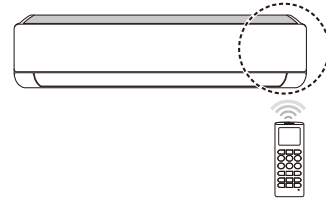

Point the remote control towards the signal receiver at the right side of the air conditioner to operate it.



NOTE

- The remote control may operate other electronic devices if it is directed towards them. Make sure to point the remote control towards the air conditioner signal receiver.
- For proper operation, use a soft cloth to clean the signal transmitter and receiver.
- In case of a function not provided in the product, no buzzer sound occurs from the product when a button for such function on the remote control is pressed except for Air Flow Direction (SWING), Energy Display (kW [3.5]), Air Purification function ().

Setting the Current Time

- 1 Insert batteries.
 - The icon below blinks at the bottom of the display screen.
- 
- 2 Press  or  button to select the minutes.
 - 3 Press **SET/CANCEL** button to finish.

NOTE

- The On/Off Timer is available after setting the current time.

Using the °C/°F Conversion Function (Optional)

This function changes unit between °C and °F

- Press and hold  button about 5 seconds.

Operating the Air Conditioner without the Remote Control

You can use the **ON/OFF** button of the indoor unit to operate the air conditioner when the remote control is unavailable.

- 1 Open the front cover (Type2) or horizontal vane (Type1).
- 2 Press the **ON/OFF** button.

Type1

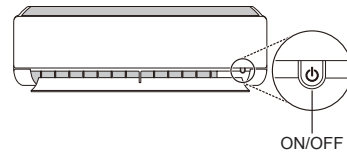

Type2

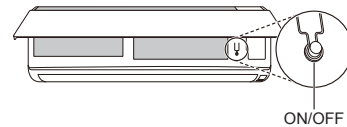

NOTE

- The stepping motor may be broken, if the horizontal vane opens rapidly.
- The fan speed is set to high.
- The feature may be changed according to the type of model.
- The temperature cannot be altered when using this emergency **ON/OFF** button.
- For cooling & heating models, the temperature is set from 22 °C to 24 °C

Using Wireless Remote Control

You can operate the air conditioner more conveniently with the remote control.

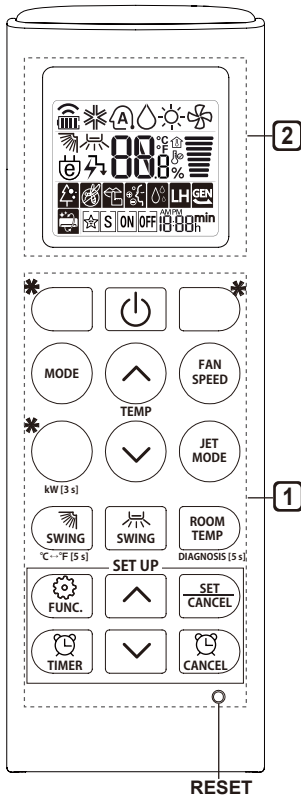

1 Button	2 Display Screen	Description	Available Function	
			Single Split	Multi
	-	To turn on/off the air conditioner.	○	○
	88°C	To adjust the desired room temperature in cooling, heating or auto changeover mode.	○	○
MODE		To select the cooling mode.	○	○
		To select the heating mode.	○	○
		To select the dehumidification mode.	○	○
		To select the fan mode.	○	○
		To select the auto changeover/auto operation mode.	○	○
JET MODE	Po	To change room temperature quickly.	○	○
FAN SPEED		To adjust the fan speed.	○	○
		To adjust the air flow direction vertically or horizontally.	○	○

NOTE



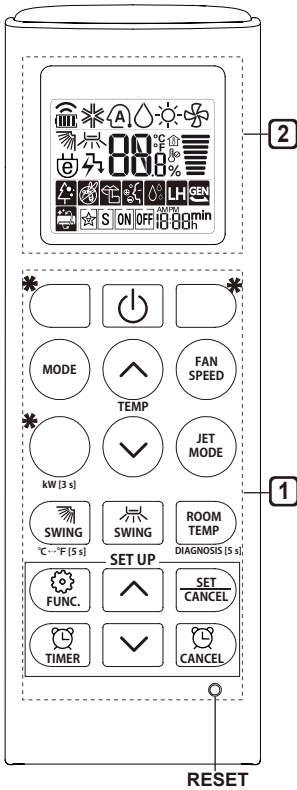



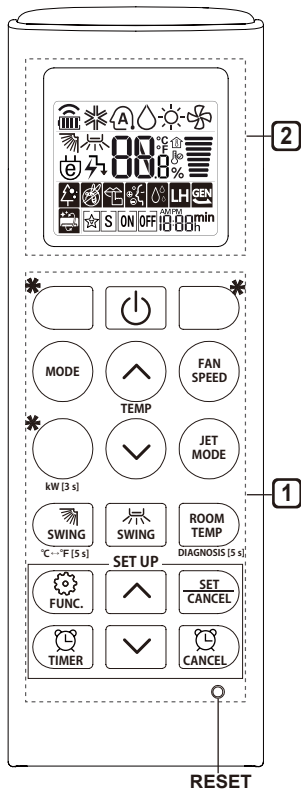

- * buttons may be changed according to the type of model.
- When connected to the Multi Outdoor unit, the Energy Display, Energy Control, Silent and Smart Diagnosis function may not be supported.



1 Button	2 Display Screen	Description	Available Function	
			Single Split	Multi
	S 	To turn on/off air conditioner automatically at desired time.	○	○
SET/ CANCEL	-	To set/cancel the special functions and timer.	○	○
	-	To cancel the timer settings.	○	○
	-	To adjust time.	○	○
*LIGHT OFF	-	To set the brightness of the display on the indoor unit.	○	○
ROOM TEMP		To display the room temperature.	○	○
°C↔°F [5 s]		To change unit between °C and °F	○	○
*ENERGY SAVING		To minimize power consumption.	○	○
*COMFORT AIR		To adjust the air flow to deflect wind.	○	○
kW [3 s]	-	To set whether or not to display information regarding energy.	○	X
*ENERGY CTRL	00 %	To bring the effect of the power saving.	X	X
*COMFORT SLEEP		To make a comfortable sleeping environment.	○	X
DIAGNOSIS [5 s]	-	To conveniently check maintenance information of a product.	○	○

RESET



1 Button	2 Display Screen	Description	Available Function	
			Single Split	Multi
		The Ion generator uses millions of ions to help improve indoor air quality.	X	X
		To reduce noise from outdoor units.	X	X
		To keep your skin moisturized by generating ion clusters.	X	X
		To lower indoor humidity quickly.	X	X
		To maintain a minimum room temperature and prevent objects in the room from freezing.	○ (Optional)	X
		To scare away a mosquito.	X	X
		To remove moisture generated inside the indoor unit.	○	○
		To make a comfortable sleeping environment.	X	X
RESET	-	To initialize the remote control settings.	○	○

NOTE

- Some functions may not be supported, depending on the model.
- * buttons may be changed according to the type of model.
- Press the **SET/CANCEL** button to operate the selected **FUNC.**

Restarting the Air Conditioner Automatically

When the air conditioner is turned on again after a power failure, this function restores the previous settings.

Disabling Auto Restart

- 1 Open the front cover (Type2) or horizontal vane (Type1).
- 2 Press the **ON/OFF** button and hold it for 6 seconds, then the unit will beep twice and the lamp will blink twice 4 times.
 - To re-enable the function, press the **ON/OFF** button and hold it for 6 seconds. The unit will beep twice and the lamp will blink 4 times.

Type1

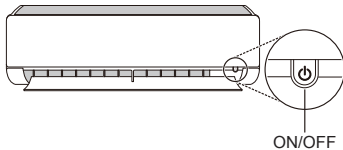

Type2

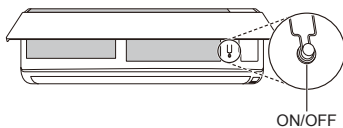

NOTE

- The feature may be changed according to the type of model.
- If you press and hold the **ON/OFF** button for 3 – 5 seconds, instead of 6 seconds, the unit will switch to the test operation. In the test operation, the unit blows out strong cooling air for 18 minutes and then returns to factory default settings.

Using the Mode Function

This function allows you to select the desired function.

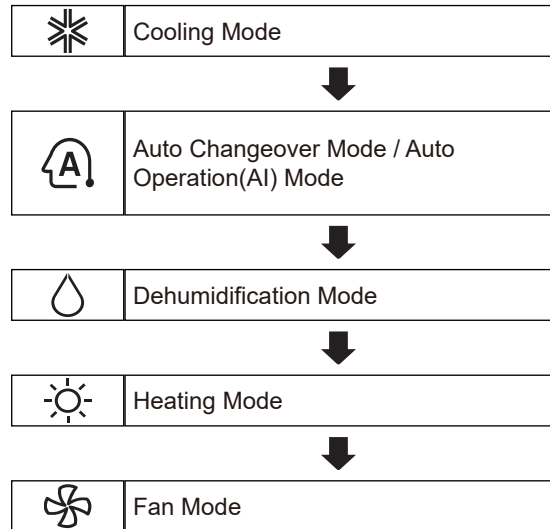



Cooling Mode

- 1 Turn the appliance on.
- 2 Press **MODE** button repeatedly to select the Cooling Mode.
 - ❄️ is displayed on the display screen.
- 3 Press \uparrow or \downarrow button to set the desired temperature.

Auto Operation (Artificial Intelligence)

Multi Model



In this operation mode, the system is automatically operated by the electronic controls.

- 1 Turn the appliance on.
- 2 Press **MODE** button repeatedly to select the Auto Operation.
 -  is displayed on the display screen.
- 3 Press  or  button to set the desired temperature.
- 4 Press **FAN SPEED** button to adjust the fan speed.

Auto Changeover Mode

Single Split Model

This mode changes the mode automatically to maintain the set temperature at ± 2 °C

- 1 Turn the appliance on.
- 2 Press **MODE** button repeatedly to select the Auto Changeover Mode.
 -  is displayed on the display screen.
- 3 Press  or  button to set the desired temperature.
- 4 Press **FAN SPEED** button to adjust the fan speed.

Dehumidification Mode



This mode removes excess moisture from a highly humid environment or during the rainy season, in order to prevent mildew from setting in. This mode adjusts the room temperature and the fan speed automatically to maintain the optimal level of humidity.

- 1 Turn the appliance on.
- 2 Press **MODE** button repeatedly to select the Dehumidification Mode.
 -  is displayed on the display screen.

NOTE

- In this mode you cannot adjust the room temperature, it is adjusted automatically.
- The room temperature is not displayed on the display screen.
- In the dehumidification mode, compressor and indoor fan may not operate when the room temperature is below 24 °C

Heating Mode

- 1 Turn the appliance on.
- 2 Press **MODE** button repeatedly to select the Heating Mode.
 -  is displayed on the display screen.
- 3 Press  or  button to set the desired temperature.

NOTE

-  will be displayed on the indoor unit when defrosting is operating.
- Furthermore, this indication will be displayed on the indoor unit:
 - When preheating is operating.
 - When the room temperature has been reached to the set temperature.

Fan Mode

This mode only circulates the indoor air without changing the room temperature.

- 1 Turn the appliance on.
- 2 Press **MODE** button repeatedly to select the Fan Mode.
 -  is displayed on the display screen.
- 3 Press **FAN SPEED** button to adjust the fan speed.

Using the Jet Mode Function





Changing Room Temperature Quickly

This function allows you to cool indoor air quickly during the summer or warm it quickly during winter.

- The Jet Mode function is available with Cooling, Heating and Dehumidification Mode.

- 1 Turn the appliance on.
- 2 Press **MODE** button repeatedly to select the desired mode.
- 3 Press **JET MODE** button.
 -  is displayed on the display screen.

NOTE

- Jet Heating Mode is not available on some models.
- In Jet Cooling Mode, strong air blows out for 30 minutes.
 - After 30 minutes later, setting temperature is maintaining 18 °C
If you want to change the temperature, Press  or  button to set the desired temperature.
- In Jet Heating Mode, strong air blows out for 30 minutes.
 - After 30 minutes later, setting temperature is maintaining 30 °C
If you want to change the temperature, Press  or  button to set the desired temperature.
- This function may operate differently from the remote control display.

Using the Fan Speed Function

Adjusting the Fan Speed

- Press **FAN SPEED** button repeatedly to adjust the fan speed.

Display Screen	Speed
	High
	Medium - High
	Medium
	Medium - Low
	Low
-	Natural Wind

NOTE

- The fan speed of Natural Wind adjusts automatically.



- The fan speed icons are displayed on some indoor units.

F1 → F2 → F3 → F4 → F5

- Indoor unit display is displayed only 5 seconds and return to the setting temperature on some models.

Using the Air Flow Direction Function

This function adjusts the direction of the air flow vertically (horizontally).

- Press button repeatedly and select the desired direction.
 - Select to adjust the direction of the air flow automatically.

NOTE

- Adjusting the air flow direction horizontally may not be supported, depending on the model.
- Adjusting the air deflector arbitrarily may cause product failure.
- If you restart the air conditioner, it starts to operate with the previously set direction of air flow, so the air deflector may not match the icon displayed on the remote control. When this occurs, press or button to adjust the direction of the air flow again.
- This function may operate differently from the remote control display.

Setting the On/Off Timer



This function sets the air conditioner to turn on/off automatically at desired time.

On/Off Timer can be set together.

Setting the On Timer

- 1 Press  button repeatedly.
 - The icon below blinks at the bottom of the display screen.



- 2 Press  or  button to select the minutes.
- 3 Press **SET/CANCEL** button to finish.
 - After setting the timer, current time and  icon are displayed on the display screen indicating that the desired time is set.

Canceling the On Timer

- 1 Press  button repeatedly.
 - The icon below blinks at the bottom of the display screen.





- 2 Press **SET/CANCEL** button to cancel the setting.

Setting the Off Timer

- 1 Press  button repeatedly.
 - The icon below blinks at the bottom of the display screen.



- 2 Press  or  button to select the minutes.
- 3 Press **SET/CANCEL** button to finish.
 - After setting the timer, current time and  icon are displayed on the display screen indicating that the desired time is set.

NOTE

- This function is disabled when you set Simple Timer.

Canceling the Off Timer

- 1 Press  button repeatedly.
 - The icon below blinks at the bottom of the display screen.



- 2 Press **SET/CANCEL** button to cancel the setting.

Canceling the Timer Setting



- Press  button to cancel all timer settings.

Using the Sleep Function (Optional)

This function turns off the air conditioner automatically when you go to sleep.

- 1 Turn the appliance on.
- 2 Press  button repeatedly.
 - The icon below blinks at the bottom of the display screen.



- 3 Press  or  button to select the hour (up to 7 hours).
- 4 Press **SET/CANCEL** button to finish.
 -  is displayed on the display screen.

NOTE



-  is displayed on some indoor units.
- Indoor unit display is displayed from 1H to 7H which is displayed only 5 seconds and then return to the setting temperature.
- In the Cooling and Dehumidification Mode, the temperature increases by 1 °C after 30 minutes and additional 1 °C after another 30 minutes for a more comfortable sleep.
- The temperature increases up to 2 °C from the preset temperature.
- Although the remark for fan speed on the display screen may be changed, the fan speed is adjusted automatically.

Using the Simple Timer Function (Optional)

This function turns off the air conditioner automatically when you go to sleep.

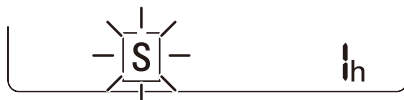
- 1 Turn the appliance on.
- 2 Press  button repeatedly.
 - The icon below blinks at the bottom of the display screen.



- 3 Press  or  button to select the hour (up to 7 hours).
- 4 Press **SET/CANCEL** button to finish.
 -  is displayed on the display screen.



NOTE

- This function is disabled when you set Off Timer.

Using the Energy Display Function (Optional)

This function displays the amount of electricity generated on the indoor display as the product operates.

Display the Current Energy Usage

- 1 Turn the appliance on.
- 2 Press  button and hold it about 3 seconds.
 - The instantaneous power consumption () is displayed for a while on some indoor units.

NOTE

- It is not displayed on the wireless remote control.
- The unit of the displayed value is kW.
- If it is more than 99 kW, which is the range of expression, maintain it as 99 kW.
- Display wattage under 10 kW with 0.1 kW unit, and display one over 10 kW with 1 kW unit.
- The actual power may differ from the power displayed.
- When connected to the Multi Outdoor unit, this function may not be supported.

Using the Light Off Function (Optional)

Display Screen Brightness

You can set the brightness of the indoor unit display screen.

- Press **LIGHT OFF** button.



NOTE

- Turn on/off the Display screen.



Using the Comfort Air Function (Optional)

Comfort Vane Operation

This function conveniently sets the vane to a preset position to deflect the supply air away from blowing directly onto the occupants in the room.

- 1 Turn the appliance on.
- 2 Press **COMFORT AIR** button repeatedly and select the desired direction.
 -  or  is displayed on the display screen.

NOTE

-  or  is displayed on some indoor units.
- This function is disabled when you press **MODE** or **JET MODE** button.
- This function is disabled and auto swing of vertical direction is set up when you press  button.
- When this function is off, the horizontal vane operates automatically depending on the set mode.

Using the Energy Saving Function (Optional)







This function minimizes power consumption during Cooling and increases the set temperature to the optimal level for a more comfortable environment. The temperature automatically settles at 22 °C if desired temperature is below 22 °C. The temperature remains constant if it is above 22 °C.

- 1 Turn the appliance on.
- 2 Press **MODE** button repeatedly to select the Cooling Mode.
- 3 Press **ENERGY SAVING** button.
 -  is displayed on the display screen.

Using the Energy Control Function (Optional)

- 1 Turn the appliance on.
- 2 Press **ENERGY CTRL** button.
 - Press **ENERGY CTRL** button repeatedly to select each step.







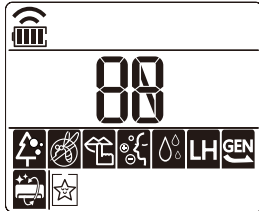

NOTE

- 1 step : The power Input is decreased by 20 % compared to rated power input.
 -  % is displayed on the display screen.
- 2 step : The power Input is decreased by 40 % compared to rated power input.
 -  % is displayed on the display screen.
- 3 step (Optional) : The power Input is decreased by 60 % compared to rated power input.
 -  % is displayed on the display screen.
-  (1 step),  (2 step) is displayed on some indoor units.
- This function is available with Cooling Mode.
- Capacity may decrease when Energy Control mode is selected.
- Desired temperature is displayed about 5 seconds if you press **FAN SPEED**,  or  button.
- Room temperature is displayed about 5 seconds if you press **ROOM TEMP** button.

Using Special Functions

- 1 Turn the appliance on.
- 2 Press **FUNC** button repeatedly to select the desired function.
- 3 Press **SET/CANCEL** button to finish.



Display Screen	Description	Available Function	
		Single Split	Multi
	The Ion generator uses millions of ions to help improve indoor air quality.	X	X
	To reduce noise from outdoor units.	X	X
	To keep your skin moisturized by generating ion clusters.	X	X
	To lower indoor humidity quickly.	X	X
	To maintain a minimum room temperature and prevent objects in the room from freezing.	O (Optional)	X
	To scare away a mosquito.	X	X
	To remove moisture generated inside the indoor unit.	O	O
	To make a comfortable sleeping environment.	X	X

NOTE

- Some functions may not be supported, depending on the model.
- Some functions may operate differently from the remote control display.

Canceling Special Functions

- 1 Press **FUNC** button repeatedly to select the desired function.
- 2 Press **SET/CANCEL** button to cancel the function.

Using the Air Purification Function

These functions supply clean and fresh air by ion particles and the filter.

Function	Display	Description
Ionizer		Ion particles from ionizer reduce the surface bacteria and other harmful substances.
Plasma		It removes microscopic contaminants from the intake air completely to supply clean and fresh air.

NOTE

- You can use this function without turning the air conditioner on.
- Both the plasma lamp and the cooling lamp light up while Smoke Away/Plasma is in operation on some models.
- Do not touch ionizer during operation.
- This function may operate differently from the remote control display.

Using the Silent Function (Optional)

This function prevents potential claims by neighbors, reducing noise from outdoor units.

-  is displayed on the display screen.

NOTE

- This function is disabled when you press **MODE** or **ENERGY CTRL** or **JET MODE** button.
- This function is available with Cooling, Heating, Auto Changeover, Auto Operation Mode.

Using the Ion Care Function (Optional)

This function keeps your skin moisturized by generating ion clusters which is absorbed into the surface of skin.

-  is displayed on the display screen about 3 seconds.

NOTE

- This function is available with Cooling, Fan Mode and Air Purification function.

Using the Jet Dry Function (Optional)

This function maximizes the performance of dehumidification.

-  are displayed on the display screen.

NOTE



- This function is available with Cooling, Dehumidification, Auto Operation, Fan Mode and Air Purification function.
- This function is not available with Sleep function.
- This function is disabled when you press **MODE** button.

Using the Low Heating Function (Optional)

This function operates the heating system to maintain a minimum room temperature and prevent objects in the room from freezing where there is no permanent resident, such as a vacation.

-  LH are displayed on the display screen.

NOTE

- This function is available with Heating Mode.
- During LH operation, when you press buttons such as , , **MODE**, **FAN SPEED**, and then return to Heating Mode.
- If **JET MODE** button is pressed during LH operation, this function is disabled and Power Heating Mode is operated immediately. (only for power heating model)
- In case an error occurred, operation can be interrupted for the protection of the product.
- **COMFORT AIR** and  button cannot be used while the LH function is in operation.

Using the Mosquito Away Function (Optional)

This function fans away mosquitos by generating a high-frequency wave.

-  is displayed on the display screen.

NOTE

- You can use this function without turning the air conditioner on.
-  is displayed on some indoor units.

Using the Auto Clean Function

In the Cooling and Dehumidification Mode, moisture is generated inside the indoor unit. This function removes such moisture.

-  is displayed on the display screen.

NOTE

- Some functions cannot be used while the Auto Clean function is in operation.
- If you turn off the unit, the fan continues to run for 30 minutes and cleans the inside of the indoor unit.
-  is displayed on some indoor units, depending on the model.

Using the Comfort Sleep Function (Optional)

This function operates the air conditioner automatically to make the comfortable sleep environment.

- , SL are displayed on the display screen.

NOTE

- This function is available with Cooling Mode.
- The vane stops swing and sets indirect airflow angle, after 30 minutes from start even though the room temperature doesn't decrease to optimal temperature to sleep.
- It is possible that a comfortable sleep environment is different according to the people.

SMART FUNCTIONS

LG ThinQ Application

This feature is only available on models with the  or **ThinQ** logo.

The **LG ThinQ** application allows you to communicate with the appliance using a smartphone.

LG ThinQ Application Features

Communicate with the appliance from a smartphone using the convenient smart features.

Smart Diagnosis™

If you experience a problem while using the appliance, this smart diagnosis feature will help you diagnose the problem.

Settings

Allows you to set various options on the appliance and in the application.

NOTE

- If you change your wireless router, internet service provider, or password, delete the registered appliance from the **LG ThinQ** application and register it again.
- The application is subject to change for appliance improvement purposes without notice to users.
- Functions may vary by model.

Before Using LG ThinQ Application

- 1 Check the distance between the appliance and the wireless router (Wi-Fi network).
 - If the distance between the appliance and the wireless router is too far, the signal strength becomes weak. It may take a long time to register or installation may fail.

- 2 Turn off the **Mobile data** or **Cellular Data** on your smartphone.

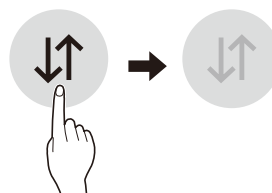

- 3 Connect your smartphone to the wireless router.

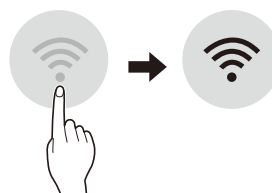

NOTE

- To verify the Wi-Fi connection, check that  icon on the control panel is lit.
- The appliance supports 2.4 GHz Wi-Fi networks only. To check your network frequency, contact your Internet service provider or refer to your wireless router manual.
- **LG ThinQ** is not responsible for any network connection problems or any faults, malfunctions, or errors caused by network connection.
- If the appliance is having trouble connecting to the Wi-Fi network, it may be too far from the router. Purchase a Wi-Fi repeater (range extender) to improve the Wi-Fi signal strength.
- The Wi-Fi connection may not connect or may be interrupted because of the home network environment.
- The network connection may not work properly depending on the Internet service provider.
- The surrounding wireless environment can make the wireless network service run slowly.

- The appliance cannot be registered due to problems with the wireless signal transmission. Unplug the appliance and wait about a minute before trying again.
- If the firewall on your wireless router is enabled, disable the firewall or add an exception to it.
- The wireless network name (SSID) should be a combination of English letters and numbers. (Do not use special characters.)
- Smartphone user interface (UI) may vary depending on the mobile operating system (OS) and the manufacturer.
- If the security protocol of the router is set to **WEP**, you may fail to set up the network. Please change it to other security protocols (**WPA2** is recommended) and register the product again.

Installing the LG ThinQ Application

Search for the **LG ThinQ** application from the Google Play Store or Apple App Store on a smartphone. Follow instructions to download and install the application.



Open Source Software Notice Information

To obtain the source code under GPL, LGPL, MPL, and other open source licenses, that is contained in this product, please visit <https://opensource.lge.com>.

In addition to the source code, all referred license terms, warranty disclaimers and copyright notices are available for download.

LG Electronics will also provide open source code to you on CD-ROM for a charge covering the cost of performing such distribution (such as the cost of media, shipping, and handling) upon email request to opensource@lge.com. This offer is valid for a period of three years after our last shipment of this product. This offer is valid to anyone in receipt of this information.

Smart Diagnosis™

This feature is only available on models with the  or  logo.

Use this feature to help you diagnose and solve problems with your appliance.

NOTE

- For reasons not attributable to LGE's negligence, the service may not operate due to external factors such as, but not limited to, Wi-Fi unavailability, Wi-Fi disconnection, local app store policy, or app unavailability.
- The feature may be subject to change without prior notice and may have a different form depending on where you are located.

Using LG ThinQ to Diagnose Issues



If you experience a problem with your Wi-Fi equipped appliance, it can transmit troubleshooting data to a smartphone using the **LG ThinQ** application.

- Launch the **LG ThinQ** application and select the **Smart Diagnosis™** feature in the menu. Follow the instructions provided in the **LG ThinQ** application.

Using Audible Diagnosis to Diagnose Issues

Follow the instructions below to use the audible diagnosis method.

- Launch the **LG ThinQ** application and select the **Smart Diagnosis™** feature in the menu. Follow the instructions for audible diagnosis provided in the **LG ThinQ** application.

- 1 Plug the power plug in the outlet properly.
- 2 Place the mouthpiece of your smartphone close to the  or  logo.
- 3 Press and hold the **DIAGNOSIS [5 s]** button for 5 seconds or longer while holding the smartphone mouthpiece to the logo until the data transfer is complete.
 - Keep the smartphone in place until the data transfer has finished. Time remaining for data transfer is displayed.
- 4 After the data transfer is complete, the diagnosis will be displayed in the application.

NOTE

- For best results, do not move the phone while the tones are being transmitted.
- Be sure to keep ambient noise to a minimum or the phone may not correctly receive the buzzer beeps from the indoor unit.

MAINTENANCE

WARNING

- Before cleaning or performing maintenance, disconnect the power supply and wait until the fan stops.

If the air conditioner will not be used for an extended period of time, dry the air conditioner to maintain it in best condition. Clean the product regularly to maintain optimal performance and to prevent possible breakdown.

- Dry the air conditioner in Fan mode for 3 to 4 hours and disconnect the power. There may be internal damage if moisture is left in its components.
- Before using the air conditioner again, dry the inner components of the air conditioner in Fan mode for 3 to 4 hours. This will help to remove the odor generated from moisture.

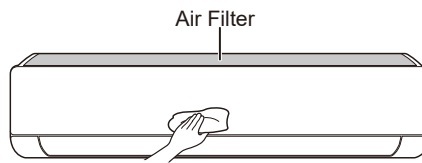

- The feature may be changed according to the type of model.

Type	Description	Interval
Air filter	Clean with a vacuum or hand wash.	2 weeks
Triple filter	Clean with a vacuum or brush.	Every 3 months
Micro dust filter	Clean with a vacuum or brush.	Once a month
Ionizer (Optional)	Use dry cotton bud to remove any dust.	Every 6 months
Indoor unit	Clean the Indoor unit surface by using a soft, dry cloth.	Regularly
	Have a professional clean the condensate drain pan.	Once a year
	Have a professional clean the condensate drain pipe.	Every 4 months
	Replace the remote control batteries.	Once a year
Outdoor unit	Have a professional clean the heat exchanger coils and the panel vents. (Consult with technician.)	Once a year
	Have a professional clean the fan.	Once a year
	Have a professional clean the condensate drain pan.	Once a year
	Have a professional verify that all the fan assembly is firmly tightened.	Once a year
	Clean the electric components with air.	Once a year

NOTE

- Never use water that is higher than 40 °C when you clean the filters. It may cause deformation or discoloration.
- Never use volatile substances when you clean the filters. They may damage the surface of the product.
- Do not wash the Micro dust filter with water, because the filter can be damaged (Optional).
- Do not wash the Triple filter with water, because the filter can be damaged (Optional).

Clean the Air Filter

Clean the air filters once every 2 weeks, or more, if necessary.

NOTE

- The air filter can be broken when it is bent.
- When the air filter is not assembled correctly, dust and other substances can enter into the indoor unit.

Type1

If you look at the indoor unit from above it, can assemble the top filter easily.

- 1 Turn off the power to the unit.
- 2 Hold the knobs of the air filter, lift it up slightly.

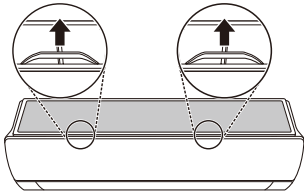

- 3 Remove it from the indoor unit.

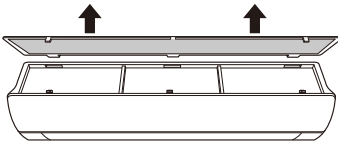

- 4 Clean the filter with a vacuum cleaner or with lukewarm water with neutral detergent.
- 5 Dry the filter in the shade.
- 6 Insert the hooks of the air filter into the front cover.

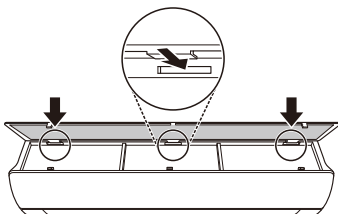

- 7 Push down hooks to assemble the air filter.

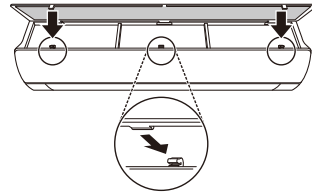

- 8 Check the side of the front cover for correct assembly of the air filter.

Type2

- 1 Turn off the power to the unit.
- 2 Open the front cover.
 - Lift up both sides of the cover slightly.
- 3 Hold the knobs of the air filters, pull them down slightly and remove them from the indoor unit.

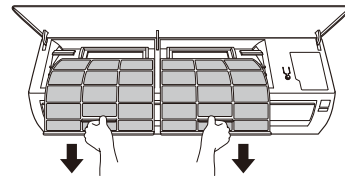

- 4 Clean the filters with a vacuum cleaner or with lukewarm water with neutral detergent.
- 5 Dry the filters in the shade.
- 6 Insert the hooks of the air filters into the front cover.

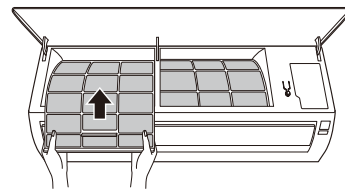

- 7 Check the side of the front cover for correct assembly of the air filters.

Clean the Micro Dust and Triple Filter (Optional)

- 1 Turn off the power to the unit.
- 2 Remove the air filters from the indoor unit.
- 3 Remove the Micro dust and Triple filter from the indoor unit.

Type1

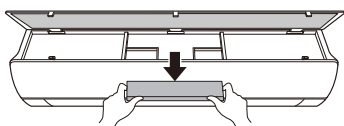

Type2

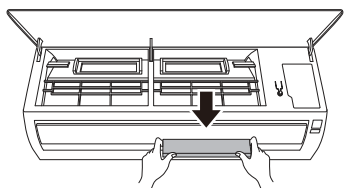

- 4 Clean the filter with a vacuum cleaner.

- 5 Insert the Micro dust and Triple filter.

Type1

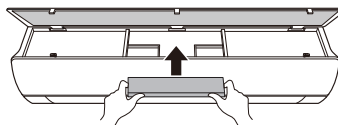

Type2

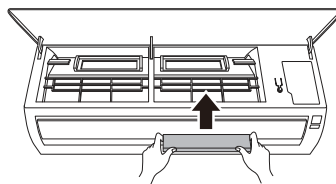

- 6 Assemble the air filters.
- 7 Check the side of the front cover for correct assembly of the air filters.

NOTE

- The feature and location of Micro dust and Triple filter may vary according to the type of model.

TROUBLESHOOTING

Self-diagnosis Function

This product has a built-in self-diagnosis function. If an error occurs, the lamp of the indoor unit will blink in 2 second intervals. If this occurs, contact your local dealer or service center.

Before Calling for Service

Please check the following before you contact the service center. If the problem persists, contact your local service center.

Symptoms	Possible Causes & Solution
The air conditioner does not work normally.	Burning smell and strange sounds are coming from the unit. <ul style="list-style-type: none"> Turn off the air conditioner, switch OFF, or disconnect the power supply, and contact the service center.
	Water leaks from the indoor unit even when the humidity level is low. <ul style="list-style-type: none"> Turn off the air conditioner, switch OFF, or disconnect the power supply, and contact the service center.
	The power cable is damaged or it is generating excessive heat. <ul style="list-style-type: none"> Turn off the air conditioner, switch OFF, or disconnect the power supply, and contact the service center.
	A switch, a circuit breaker (safety, ground), or a fuse is not operated properly. <ul style="list-style-type: none"> Turn off the air conditioner, switch OFF, or disconnect the power supply, and contact the service center.
	The unit generates an error code from its self-diagnosis. <ul style="list-style-type: none"> Turn off the air conditioner, switch OFF, or disconnect the power supply, and contact the service center.
The air conditioner does not work.	The air conditioner is unplugged. <ul style="list-style-type: none"> Check whether the power cord is plugged into the outlet or the power isolators are switched on.
	A fuse exploded, or the power supply is blocked. <ul style="list-style-type: none"> Replace the fuse or check if the circuit breaker has tripped.
	A power failure has occurred. <ul style="list-style-type: none"> Turn off the air conditioner when a power failure occurs. When the power is restored, wait 3 minutes, and then turn on the air conditioner.
	The voltage is too high or too low. <ul style="list-style-type: none"> Check if the circuit breaker has tripped.
	The air conditioner was turned off automatically at a preset time. <ul style="list-style-type: none"> Turn the air conditioner on.
	The battery setting in the remote controller is incorrect. <ul style="list-style-type: none"> Make sure that the batteries are inserted correctly in your remote controller. If the batteries are placed correctly, but the air conditioner still does not operate, replace the batteries and try again.

Symptoms	Possible Causes & Solution
<p>The air conditioner does not emit cool air.</p>	<p>Air is not circulating properly.</p> <ul style="list-style-type: none"> • Make sure that there are no curtains, blinds, or pieces of furniture blocking the front of the air conditioner.
	<p>The air filter is dirty.</p> <ul style="list-style-type: none"> • Clean the air filter once every 2 weeks. • See “Clean the Air Filter” for more information.
	<p>The room temperature is too high.</p> <ul style="list-style-type: none"> • In summer, cooling the indoor air fully may take some time. In this case, select the Jet Mode to cool the indoor air quickly.
	<p>Cold air is escaping from the room.</p> <ul style="list-style-type: none"> • Make sure that no cold air is escaping through the ventilation points in the room.
	<p>The desired temperature is higher than the current temperature.</p> <ul style="list-style-type: none"> • Set the desired temperature to a level lower than the current temperature.
	<p>There is a heating source nearby.</p> <ul style="list-style-type: none"> • Avoid using heat generators like electric ovens or gas burners while the air conditioner is in operation.
	<p>Fan Mode is selected.</p> <ul style="list-style-type: none"> • During Fan Mode, air blows from the air conditioner without cooling or heating the indoor air. • Switch the operation mode to cooling operation.
	<p>Outside temperature is too high.</p> <ul style="list-style-type: none"> • The cooling effect may not be sufficient.
<p>The fan speed cannot be adjusted.</p>	<p>The Jet Mode, or Auto Operation Mode is selected.</p> <ul style="list-style-type: none"> • In some operation modes, you cannot adjust the fan speed. Select an operation mode in which you can adjust the fan speed.
<p>The temperature cannot be adjusted.</p>	<p>The Fan Mode or Jet Mode is selected.</p> <ul style="list-style-type: none"> • In some operation modes, you cannot adjust the temperature. Select an operation mode in which you can adjust the temperature.
<p>The air conditioner stops during operation.</p>	<p>The air conditioner is suddenly turned off.</p> <ul style="list-style-type: none"> • The Timer Function may have timed out, which turns the unit off. Check the timer settings.
	<p>A power failure has occurred during operation.</p> <ul style="list-style-type: none"> • Wait for the power to come back. If you have the Auto Restart function enabled, your unit will resume its last operation several minutes after power is restored.

Symptoms	Possible Causes & Solution
The indoor unit is still operating even when the unit has been turned off.	<p>The Auto Clean function is being operated.</p> <ul style="list-style-type: none"> • Allow the Auto Clean function to continue since it removes any remaining moisture inside the indoor unit. If you do not want this feature, you can turn the unit off.
The air outlet on the indoor unit is discharging mist.	<p>The cooled air from the air conditioner makes mist.</p> <ul style="list-style-type: none"> • When the room temperature decreases, this phenomenon will disappear.
Water leaks from the outdoor unit.	<p>In the heating operations, condensed water drops from the heat exchanger.</p> <ul style="list-style-type: none"> • This symptom requires installing a drain hose under the base pan. Contact the installer.
There is noise or vibration.	<p>A clicking sound can be heard when the unit starts or stops due to movement of the reversing valve.</p> <p>Creaking sound: The plastic parts of the indoor unit creak when they shrink or expand due to sudden temperature changes.</p> <p>Flowing or Blowing sound: This is the flow of refrigerant through the air conditioner.</p> <ul style="list-style-type: none"> • These are normal symptoms. The noise will stop.
The indoor unit gives off an odor.	<p>Odors (such as cigarette smoke) may be absorbed into the indoor unit and discharged with airflow.</p> <ul style="list-style-type: none"> • If the smell does not disappear, you need to wash the filter. If this does not work, contact the service center to clean your heat exchanger.
The air conditioner does not emit warm air.	<p>When Heating Mode starts, the vane is almost closed, and no air comes out, even though the outdoor unit is operating.</p> <ul style="list-style-type: none"> • This symptom is normal. Please wait until the unit has generated enough warm air to blow through the indoor unit.
	<p>The outdoor unit is in Defrosting Mode.</p> <ul style="list-style-type: none"> • In Heating Mode, ice/frost is built up on the coils when the outside temperature falls. This function removes a layer of frost on the coil, and it should finish in approximately 15 minutes.
	<p>Outside temperature is too low.</p> <ul style="list-style-type: none"> • The heating effect may not be sufficient.

Symptoms	Possible Causes & Solution
Your home appliance and smartphone is not connected to the Wi-Fi network.	The password for the Wi-Fi that you are trying to connect to is incorrect. <ul style="list-style-type: none"> Find the Wi-Fi network connected to your smartphone and remove it, then register your appliance on LG ThinQ.
	Mobile data for your smartphone is turned on. <ul style="list-style-type: none"> Turn off the Mobile data of your smartphone and register the appliance using the Wi-Fi network.
	The wireless network name (SSID) is set incorrectly. <ul style="list-style-type: none"> The wireless network name (SSID) should be a combination of English letters and numbers. (Do not use special characters.)
	The router frequency is not 2.4 GHz. <ul style="list-style-type: none"> Only a 2.4 GHz router frequency is supported. Set the wireless router to 2.4 GHz and connect the appliance to the wireless router. To check the router frequency, check with your Internet service provider or the router manufacturer.
	The distance between the appliance and the router is too far. <ul style="list-style-type: none"> If the distance between the appliance and the router is too far, the signal may be weak and the connection may not be configured correctly. Move the location of the router so that it is closer to the appliance.

NOTE

- Some functions may not be supported, depending on the model.

WARRANTY (USA)

ARBITRATION NOTICE: THIS LIMITED WARRANTY CONTAINS AN ARBITRATION PROVISION THAT REQUIRES YOU AND LG TO RESOLVE DISPUTES BY BINDING ARBITRATION INSTEAD OF IN COURT, UNLESS YOU CHOOSE TO OPT OUT. IN ARBITRATION, CLASS ACTIONS AND JURY TRIALS ARE NOT PERMITTED. PLEASE SEE THE SECTION TITLED "PROCEDURE FOR RESOLVING DISPUTES" BELOW.

PROCEDURE FOR RESOLVING DISPUTES:

ALL DISPUTES BETWEEN YOU AND LG ARISING OUT OF OR RELATING IN ANY WAY TO THIS LIMITED WARRANTY OR THE PRODUCT SHALL BE RESOLVED EXCLUSIVELY THROUGH BINDING ARBITRATION, AND NOT IN A COURT OF GENERAL JURISDICTION. BINDING ARBITRATION MEANS THAT YOU AND LG ARE EACH WAIVING THE RIGHT TO A JURY TRIAL AND TO BRING OR PARTICIPATE IN A CLASS ACTION.

Definitions. For the purposes of this section, references to "LG" mean LG Electronics U.S.A., Inc., its parents, subsidiaries and affiliates, and each of their officers, directors, employees, agents, beneficiaries, predecessors in interest, successors, assigns and suppliers; references to "dispute" or "claim" shall include any dispute, claim or controversy of any kind whatsoever (whether based in contract, tort, statute, regulation, ordinance, fraud, misrepresentation or any other legal or equitable theory) arising out of or relating in any way to the sale, condition or performance of the product or this Limited Warranty.

Notice of Dispute. In the event you intend to commence an arbitration proceeding, you must first notify LG in writing at least 30 days in advance of initiating the arbitration by sending a letter to LG at LG Electronics, USA, Inc. Attn: Legal Department- Arbitration 111 Sylvan Avenue, Englewood Cliffs, NJ 07632. You and LG agree to engage in good faith discussions in an attempt to amicably resolve your claim. The notice must provide your name, address, and telephone number; identify the product that is the subject of the claim; and describe the nature of the claim and the relief being sought. If you and LG are unable to resolve the dispute within 30 days, either party may proceed to file a claim for arbitration.

Agreement to Binding Arbitration and Class Action Waiver. Upon failure to resolve the dispute during the 30 day period after sending written notice to LG, you and LG agree to resolve any claims between us only by binding arbitration on an individual basis, unless you opt out as provided below. Any dispute between you and LG shall not be combined or consolidated with a dispute involving any other person's or entity's product or claim. More specifically, without limitation of the foregoing, any dispute between you and LG shall not under any circumstances proceed as part of a class or representative action. Instead of arbitration, either party may bring an individual action in small claims court, but that small claims court action may not be brought on a class or representative basis.

Arbitration Rules and Procedures. To begin arbitration of a claim, either you or LG must make a written demand for arbitration. The arbitration will be administered by the American Arbitration Association ("AAA") and will be conducted before a single arbitrator under the AAA's Consumer Arbitration Rules that are in effect at the time the arbitration is initiated (referred to as the "AAA Rules") and under the procedures set forth in this section. The AAA Rules are available online at www.adr.org/consumer. Send a copy of your written demand for arbitration, as well as a copy of this provision, to the AAA in the manner described in the AAA Rules. You must also send a copy of your written demand to LG at LG Electronics, USA, Inc. Attn: Legal Department- Arbitration 111 Sylvan Avenue, Englewood Cliffs, NJ 07632. If there is a conflict between the AAA Rules and the rules set forth in this section, the rules set forth in this section will govern. This arbitration provision is governed by the Federal Arbitration Act. Judgment may be entered on the arbitrator's award in any court of competent jurisdiction. All issues are for the arbitrator to decide, except that issues relating to the scope and enforceability of the arbitration provision and to the arbitrability of the dispute are for the court to decide. The arbitrator is bound by the terms of this provision.

Governing Law. The law of the state of your residence shall govern this Limited Warranty and any disputes between us except to the extent that such law is preempted by or inconsistent with applicable federal law.

Fees/Costs. You do not need to pay any fee to begin an arbitration. Upon receipt of your written demand for arbitration, LG will promptly pay all arbitration filing fees to the AAA unless you seek more than \$25,000 in damages, in which case the payment of these fees will be governed by the AAA Rules. Except as otherwise provided for herein, LG will pay all AAA filing, administration and arbitrator fees for any arbitration initiated in accordance with the AAA Rules and this arbitration provision. If you prevail in the arbitration, LG will pay your attorneys' fees and expenses as long as they are reasonable, by considering factors including, but not limited to, the purchase amount and claim amount. Notwithstanding the foregoing, if applicable law allows for an award of reasonable attorneys' fees and expenses, an arbitrator can award them to the same extent that a court would. If the arbitrator finds either the substance of your claim or the relief sought in the demand is frivolous or brought for an improper purpose (as measured by the standards set forth in Federal Rule of Civil Procedure 11(b)), then the payment of all arbitration fees will be governed by the AAA Rules. In such a situation, you agree to reimburse LG for all monies previously disbursed by it that are otherwise your obligation to pay under the AAA Rules. Except as otherwise provided for, LG waives any rights it may have to seek attorneys' fees and expenses from you if LG prevails in the arbitration.

Hearings and Location. If your claim is for \$25,000 or less, you may choose to have the arbitration conducted solely on the basis of (1) documents submitted to the arbitrator, (2) through a telephonic hearing, or (3) by an in-person hearing as established by the AAA Rules. If your claim exceeds \$25,000, the right to a hearing will be determined by the AAA Rules. Any in-person arbitration hearings will be held at a location within the federal judicial district in which you reside unless we both agree to another location or we agree to a telephonic arbitration.

Opt Out. You may opt out of this dispute resolution procedure. If you opt out, neither you nor LG can require the other to participate in an arbitration proceeding. To opt out, you must send notice to LG no later than 30 calendar days from the date of the first consumer purchaser's purchase of the product by either: (i) sending an e-mail to optout@lge.com, with the subject line: "Arbitration Opt Out" or (ii) calling 1-800-980-2973. You must include in the opt out e-mail or provide by telephone: (a) your name and address; (b) the date on which the product was purchased; (c) the product model name or model number; and (d) the serial number (the serial number can be found (i) on the product; or (ii) online by accessing <https://www.lg.com/us/support/repair-service/schedule-repair-continued> and clicking on "Find My Model & Serial Number").

You may only opt out of the dispute resolution procedure in the manner described above (that is, by e-mail or telephone); no other form of notice will be effective to opt out of this dispute resolution procedure. Opting out of this dispute resolution procedure will not affect the coverage of the Limited Warranty in any way, and you will continue to enjoy the full benefits of the Limited Warranty. If you keep this product and do not opt out, then you accept all terms and conditions of the arbitration provision described above.

WARRANTY (CANADA)

ARBITRATION NOTICE: THIS LIMITED WARRANTY CONTAINS AN ARBITRATION PROVISION THAT REQUIRES YOU AND LG TO RESOLVE DISPUTES BY BINDING ARBITRATION INSTEAD OF IN COURT, UNLESS THE LAWS OF YOUR PROVINCE OR TERRITORY DO NOT PERMIT THAT, OR, IN OTHER JURISDICTIONS, IF YOU CHOOSE TO OPT OUT. IN ARBITRATION, CLASS ACTIONS AND JURY TRIALS ARE NOT PERMITTED. PLEASE SEE THE SECTION TITLED “PROCEDURE FOR RESOLVING DISPUTES” BELOW.

PROCEDURE FOR RESOLVING DISPUTES:

EXCEPT WHERE PROHIBITED AT LAW, ALL DISPUTES BETWEEN YOU AND LG ARISING OUT OF OR RELATING IN ANY WAY TO THIS LIMITED WARRANTY OR THE PRODUCT SHALL BE RESOLVED EXCLUSIVELY THROUGH BINDING ARBITRATION, AND NOT IN A COURT OF GENERAL JURISDICTION. EXCEPT WHERE PROHIBITED AT LAW, YOU AND LG BOTH IRREVOCABLY AGREE TO WAIVE THE RIGHT TO A JURY TRIAL AND TO BRING OR PARTICIPATE IN A CLASS ACTION.

Definitions. For the purposes of this section, references to “LG” mean LG Electronics Canada, Inc., its parents, subsidiaries and affiliates, and each of their officers, directors, employees, agents, beneficiaries, predecessors in interest, successors, assigns and suppliers; references to “dispute” or “claim” shall include any dispute, claim or controversy of any kind whatsoever (whether based in contract, tort, statute, regulation, ordinance, fraud, misrepresentation or any other legal or equitable theory) arising out of or relating in any way to the sale, condition or performance of the product or this Limited Warranty.

Notice of Dispute. In the event you intend to commence an arbitration proceeding, you must first notify LG in writing at least 30 days in advance of initiating the arbitration by sending a letter to LGECI Legal Team at 20 Norelco Drive, North York, Ontario, Canada M9L 2X6 (the “Notice of Dispute”). You and LG agree to engage in good faith discussions in an attempt to amicably resolve your claim. The notice must provide your name, address, and telephone number; identify the product that is the subject of the claim; and describe the nature of the claim and the relief being sought. If you and LG are unable to resolve the dispute within 30 days of LG’s receipt of the Notice of Dispute, the dispute shall be resolved by binding arbitration in accordance with the procedure set out herein. You and LG both agree that, during the arbitration proceeding, the terms (including any amount) of any settlement offer made by either you or LG will not be disclosed to the arbitrator until the arbitrator determines the dispute.

Agreement to Binding Arbitration and Class Action Waiver. Upon failure to resolve the dispute during the 30 day period after LG’s receipt of the Notice of Dispute, you and LG agree to resolve any claims between you and LG only by binding arbitration on an individual basis, unless you opt out as provided below, or you reside in a jurisdiction that prevents full application of this clause in the circumstances of the claims at issue (in which case if you are a consumer, this clause will only apply if you expressly agree to the arbitration). To the extent permitted by applicable law, any dispute between you and LG shall not be combined or consolidated with a dispute involving any other person’s or entity’s product or claim. More specifically, without limitation of the foregoing, except to the extent such a prohibition is not permitted at law, any dispute between you and LG shall not under any circumstances proceed as part of a class or representative action. Instead of arbitration, either party may bring an individual action in small claims court, but that small claims court action may not be brought on a class or representative basis except to the extent this prohibition is not permitted at law in your province or territory of jurisdiction as it relates to the claims at issue between you and LG.

Arbitration Rules and Procedures. To begin arbitration of a claim, either you or LG must make a written demand for arbitration. The arbitration will be private and confidential, and conducted on a simplified and expedited basis before a single arbitrator chosen by the parties under the provincial or territorial commercial arbitration law and rules of the province or territory of your residence. You must also send a copy of your written demand to LG at LG Electronics, Canada, Inc., Attn: Legal Department- Arbitration, 20 Norelco Drive, North York, Ontario M9L 2X6. This arbitration provision is governed by your applicable provincial or territorial commercial arbitration legislation. Judgment may be entered on the arbitrator’s award in any court of competent jurisdiction. All issues are for the arbitrator to decide, except that, issues relating to the scope and enforceability of the arbitration provision and to the arbitrability of the dispute are for the court to decide. The arbitrator is bound by the terms of this provision.

Governing Law. The law of the province or territory of your purchase shall govern this Limited Warranty and any disputes between you and LG except to the extent that such law is preempted by or inconsistent with applicable federal or provincial/territorial law. Should arbitration not be permitted for any claim, action, dispute or controversy between you and LG, you and LG attorn to the exclusive jurisdiction of the courts of the province or territory of your purchase for the resolution of the claim, action, dispute or controversy between you and LG.

Fees/Costs. You do not need to pay any fee to begin an arbitration. Upon receipt of your written demand for arbitration, LG will promptly pay all arbitration filing fees unless you seek more than \$25,000 in damages, in which case the payment of these fees will be governed by the applicable arbitration rules. Except as otherwise provided for herein, LG will pay all filing, administration and arbitrator fees for any arbitration initiated in accordance with the applicable arbitration rules and this arbitration provision. If you prevail in the arbitration, LG will pay your attorneys' fees and expenses as long as they are reasonable, by considering factors including, but not limited to, the purchase amount and claim amount. Notwithstanding the foregoing, if applicable law allows for an award of reasonable attorneys' fees and expenses, an arbitrator can award them to the same extent that a court would. If the arbitrator finds either the substance of your claim or the relief sought in the demand is frivolous or brought for an improper purpose (as measured by the applicable laws), then the payment of all arbitration fees will be governed by the applicable arbitration rules. In such a situation, you agree to reimburse LG for all monies previously disbursed by it that are otherwise your obligation to pay under the applicable arbitration rules. Except as otherwise provided for, LG waives any rights it may have to seek attorneys' fees and expenses from you if LG prevails in the arbitration.

Hearings and Location. If your claim is for \$25,000 or less, you may choose to have the arbitration conducted solely (1) on the basis of documents submitted to the arbitrator, (2) through a telephonic hearing, or (3) by an in-person hearing as established by the applicable arbitration rules. If your claim exceeds \$25,000, the right to a hearing will be determined by the applicable arbitration rules. Any in-person arbitration hearings will be held at the nearest, most mutually-convenient arbitration location available within the province or territory in which you reside unless you and LG both agree to another location or agree to a telephonic arbitration.

Severability and Waiver. If any portion of this Limited Warranty (including these arbitration procedures) is unenforceable, the remaining provisions will continue in full force and effect to the maximum extent permitted by applicable law. Should LG fail to enforce strict performance of any provision of this Limited Warranty (including these arbitration procedures), it does not mean that LG intends to waive or has waived any provision or part of this Limited Warranty.

Opt Out. You may opt out of this dispute resolution procedure. If you opt out, neither you nor LG can require the other to participate in an arbitration proceeding. To opt out, you must send notice to LG no later than 30 calendar days from the date of the first consumer purchaser's purchase of the product by either (i) sending an e-mail to optout@lge.com, with the subject line: "Arbitration Opt Out;" or (ii) calling 1-800-980-2973. You must include in the opt out e-mail or provide by telephone: (a) your name and address; (b) the date on which the product was purchased; (c) the product model name or model number; and (d) the serial number (the serial number can be found (i) on the product; or (ii) online by accessing https://www.lg.com/ca_en/support/repair-service/schedule-repair and clicking on "Find My Model & Serial Number").

In the event that you "Opt Out", the law of the province or territory of your residence shall govern this Limited Warranty and any disputes between you and LG except to the extent that such law is preempted by or inconsistent with applicable federal or provincial/territorial law. Should arbitration not be permitted for any claim, action, dispute or controversy between you and LG, you and LG agree to attorn to the exclusive jurisdiction of the courts of the province or territory of your residence for the resolution of the claim, action, dispute or controversy between you and LG.

You may only opt out of the dispute resolution procedure in the manner described above (that is, by e-mail or telephone); no other form of notice will be effective to opt out of this dispute resolution procedure. Opting out of this dispute resolution procedure will not affect the coverage of the Limited Warranty in any way, and you will continue to enjoy the full benefits of the Limited Warranty. If you keep this product and do not opt out, then you accept all terms and conditions of the arbitration provision described above.

Conflict of Terms. In the event of a conflict or inconsistency between the terms of this Limited Warranty and the End User License Agreement ("EULA") in regards to dispute resolution, the terms of this Limited Warranty shall control and govern the rights and obligations of the parties and shall take precedence over the EULA.



US	Please call the installing contractor of your product, as warranty service will be provided by them.
CANADA	Service call Number # : (888) LG Canada, (888) 542-2623 Numéro pour les appels de service : LG Canada, 1-888-542-2623