

2

1

REV	EC.NO.	DATE	DESCRIPTION	DFTR	CK.
A			INITIAL RELEASE		

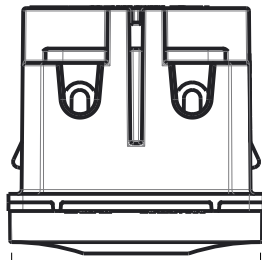

1.73
[43,9]

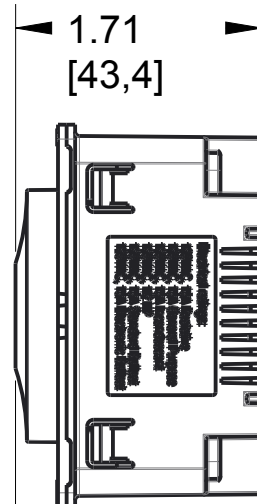

1.71
[43,4]

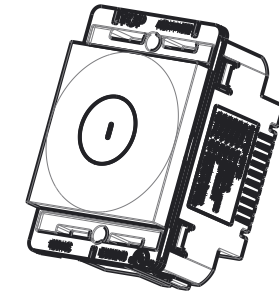
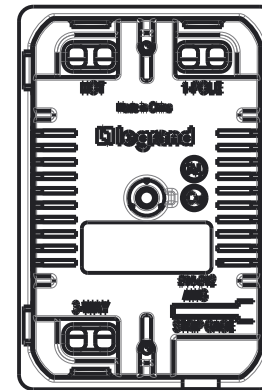
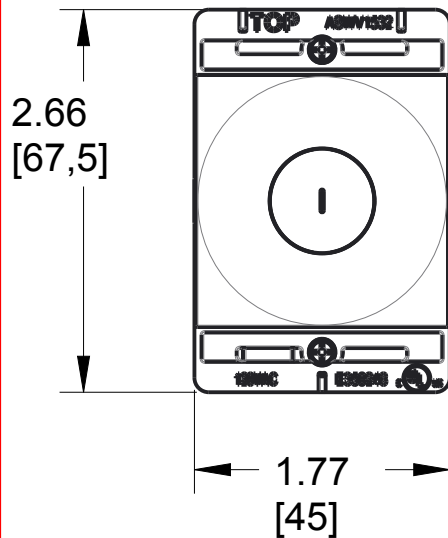

SCALE 0.500

B



B

A

A

Size Face: 2x2 Module
 Size Backbody: 3x2 Module
 3rd Party Compliance: cULus LISTED
 Rating:
 15A, 120VAC, 1/2Hp, All Loads
 Termination: Back Wire Only
 Misc: Copper Wire Only
 Accepts Locator Status Light
 For Use With adorne System Only

ASWV1532, Wave Switch

MATERIAL	SEE NOTE	UNSPECIFIED TOL. FRAC. $\pm 1/64$ ANGLES ± 1.0 DEC. 0 ± 0.02 $.00 \pm 0.01$ $.000 \pm 0.005$	 Pass & Seymour  Legrand		
FINISH	SEE NOTE				MODEL NAME: ASWV1532
DSGN BY:	5/26/2015		DR BY:	PROJ.	DWG NO.: CD1169
CK BY:		SHT 1 of 1	SCALE: 0.750		

NOTICE: Proprietary and confidential information of Pass & Seymour/Legrand
 Reproduction or disclosure prohibited under penalty of law.

2

1