

ASPD1531, ASPD1532, ASPD1542, ASPD2032, ASPD2042

Paddle™ Style Switches

adorne[®] Paddle™ Style Switches feature a wide graceful paddle that works with a simple up and down motion, allowing you to turn lights on and off with ease. Integral silver contacts provide long-lasting performance.

Pair a Locator Status Light with your Paddle switch to add illumination and make it easier to locate in the dark. adorne[®] Paddle™ Style Switches are available in white or magnesium finishes to complement the broad range of adorne device plate options that are available.

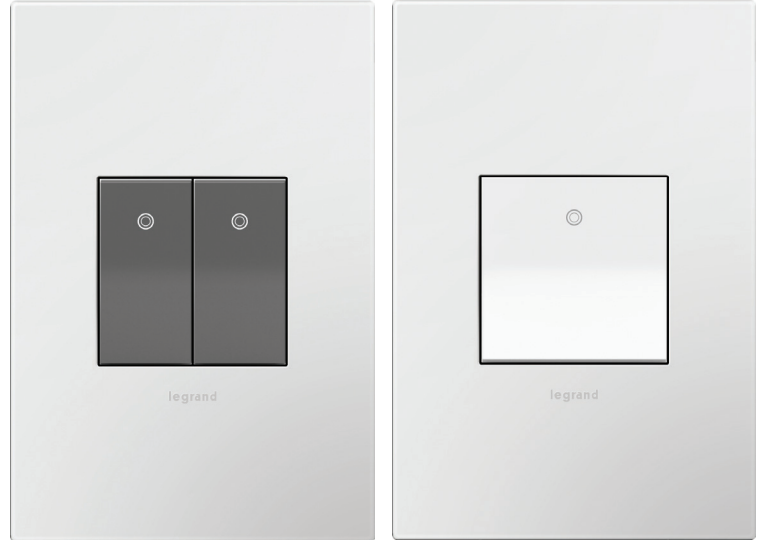

adorne Paddle Switches are available in both one- and two-module versions. Custom laser engraving is available for select projects.

FEATURES & BENEFITS

adorne devices fit in all existing NEMA-approved wallboxes.

Heavy gauge steel frame is grounded via factory installed 12AWG ground lead. Device and metal wall plates are self-grounded to frame.

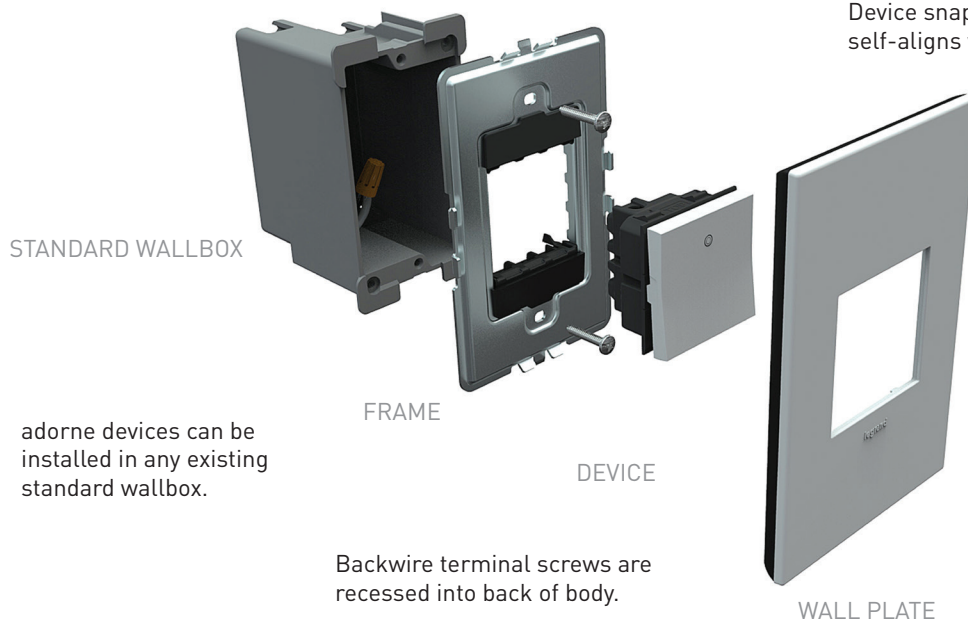

Device snaps into the frame and self-aligns without any screws.

Wall plate snaps onto frame; no screws required.

Modular system solves device alignment problems, improving fit and finish in multi-gang installations.

Wall plate and frames available in 1-6 gang sizes.

adorne devices can be installed in any existing standard wallbox.

Backwire terminal screws are recessed into back of body.

ORDERING INFORMATION

Single-Pole & 3-Way Switches

CATALOG NUMBER	DESCRIPTION	RATING	COMPLIANCE	COLORS	COO
ASPD1532M277	Single-Pole/3-Way Switches	15A, 120/277 VAC		Magnesium	China
ASPD1532M4	Single-Pole/3-Way Switches	15A, 120 VAC		Magnesium	China
ASPD1532W277	Single-Pole/3-Way Switches	15A, 120/277 VAC		White	China
ASPD1532W4	Single-Pole/3-Way Switches	15A, 120 VAC		White	China
ASPD2032M4	Single-Pole/3-Way Switches	20A, 120 VAC		Magnesium	China
ASPD2032W4	Single-Pole/3-Way Switches	20A, 120 VAC		White	China

4-Way Switches

CATALOG NUMBER	DESCRIPTION	RATING	COMPLIANCE	COLORS	COO
ASPD1542M277	4-Way Switches	15A, 120/277 VAC		Magnesium	Mexico
ASPD1542W277	4-Way Switches	15A, 120/277 VAC		White	Mexico
ASPD2042M4	4-Way Switches	20A, 120 VAC		Magnesium	Mexico
ASPD2042W4	4-Way Switches	20A, 120 VAC		White	Mexico

Half Size Paddle Switches

CATALOG NUMBER	DESCRIPTION	RATING	COMPLIANCE	COLORS	COO
ASPD1531M4	Single-Pole/3-Way Switches	15A, 120 VAC		Magnesium	China
ASPD1531W4	Single-Pole/3-Way Switches	15A, 120VAC		White	China
ASPD1531M277	Single-Pole/3-Way Switches	20A, 120/277 VAC		Magnesium	China
ASPD1531W277	Single-Pole/3-Way Switches	20A, 120/277 VAC		White	China

Accessories, Locator Status Light

AALS6



Locator Status Light – 120V

Add a stylish, small locator light to your Paddle switch or dimmer and you'll never again have to slide your hand across the wall trying to find that switch.

Locator light is on when the load is off and off when the load is on.



AALS277

Locator Status Light – 277V

Add a stylish, small locator light to your Paddle switch or dimmer and you'll never again have to slide your hand across the wall trying to find that switch



VERTICAL MARKETS

- Residential
- Hospitality
- Luxury Office
- Light Commercial

TECHNICAL SPECIFICATIONS

3rd Party Compliance

cULus Listed, File Number E140597, Standard UL20, General Use Snap Switches

Performance

ELECTRICAL

Dielectric Voltage	Withstands 1500V minimum
Maximum Working Voltage	120VAC
Overload	Minimum 4.8 times rated current for 100 cycles
Current Rated	15A interrupting at full-rated current
Temperature Rise	30°C Maximum at full-rated current
Endurance	30,000 total cycles; 10,000 cycles resistive load, 10,000 cycles inductive load and 10,000 cycles Tungsten filament load

MECHANICAL

Back Wire	With internal pressure plates, #8-32 screw
Terminal Accommodations	#14AWG-#12AWG

ENVIRONMENTAL

Flammability	UL94 V2
--------------	---------



Materials

Paddle	Polycarbonate	Terminal	Brass
Back Body	Polycarbonate	Termination	Steel Plated Screws
Contacts	Silver		

Warranty

Limited Lifetime Warranty

COMPLEMENTARY PRODUCTS

adorne® also offers Paddle Style Dimmers and Fan Control Devices to pair with our Paddle Style Switches for an overall, aesthetically pleasing and multi-functional installation.

adorne® Wall Plates provide the perfect complement to adorne Switches, Dimmers, Outlets, and Accessories. The collection includes a variety of finishes, from metals to leather and wood, as well as plastic plates that are available in contemporary and classic colors.

Each wall plate is packaged with a metal frame to enable easy installation when paired with a device. All plates are screwless and simply snap onto the included metal frame.

All adorne wall plates are UL and ETL-approved.



2-Module Paddle Dimmer



2-Module Paddle Fan Speed Control



1-Module Paddle Switch

COMPLEMENTARY DEVICES & ACCESSORIES



sofTap™

Switches & Dimmers – designed with an innovative micro-movement that turns lights on and off with just a soft “tap” of the finger.



SensaSwitch™

Switches & Dimmers – Sensor turns lights on when you enter a room and off when you leave. (Also available in Manual-ON/Auto-OFF format.)



Whisper™

Switches & Dimmers – A smart design that features elegant lines and a quiet, fluid motion.

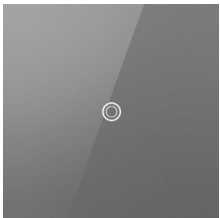

Touch™

Switches & Dimmers – A stunning translucent face works just like an iPhone® — simply touch your finger on the circle to turn lights on and off.

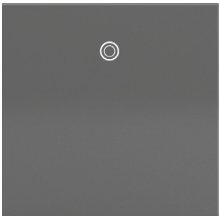

Paddle™

Switches, Dimmers & Fan Speed Controls – A wide, graceful curve works with a simple up-and-down motion, allowing you to turn lights on and off with ease.

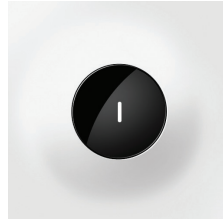

Wave™

Switches – Smart technology combined with sleek, modern design. Simply wave your hand to turn lights on and off.



Push™

Switches – A tactile, finger-sized impression lets you turn lights on and off with a simple push-button motion.

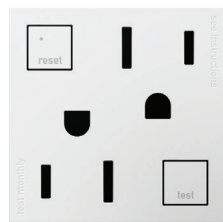

Tamper-Resistant Outlets/ Tamper-Resistant GFCI Outlets



USB Charging Outlets

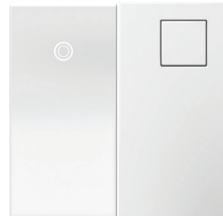

Nightlight/Portable Nightlight Flashlight

PLUS: Compatible Wall Plates, Accent Lights, Locator Lights, Under-Cabinet Lighting System

NOTE: All brand and product names referenced in this document are registered trademarks or trademarks of their respective holders.



NOTE: The paper used to print this document is an environmentally responsible paper with 10% post consumer waste, with FSC and SFI Chain of Custody certifications, Lacey Act compliant. 100% of the electricity used to manufacture Flo sheets is generated with Green-e certified renewable energy.



Legrand, North America
60 Woodlawn Street
West Hartford, CT 06110
1.877.BY.LEGRAND (295.3472)
www.legrand.us

Canada
905.738.9195
www.legrand.ca

FOLLOW US

