

Flute

HS194_IA50FSJ

1.2



GENERAL PRODUCT INFORMATION:



This product is ETL listed and suitable only for indoor dry locations and approved for use at any height above the finished floor.



Adjust the Fixture Height

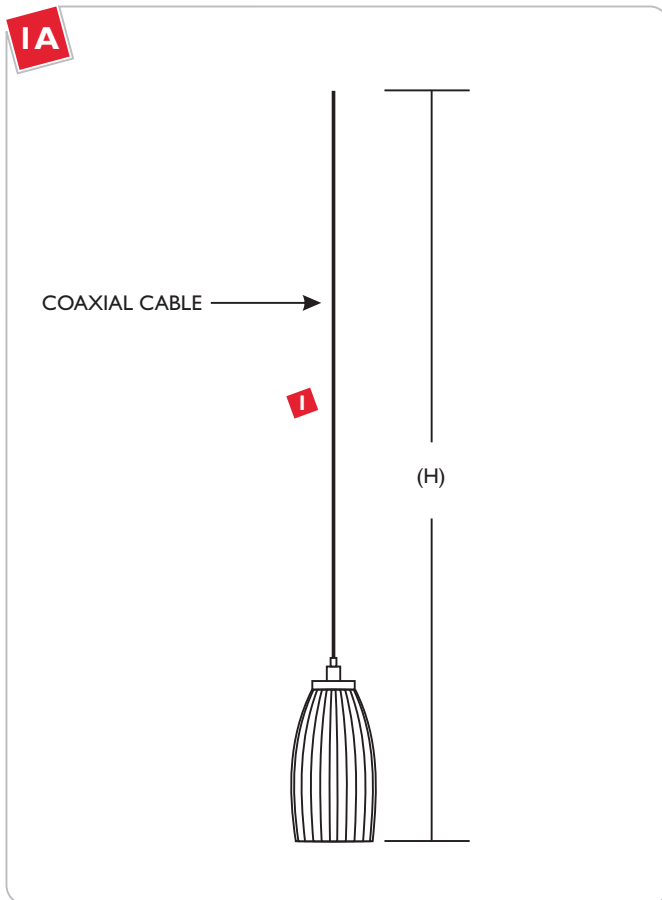

1 Cut the coaxial cable to the desired length with a sharp cutter. The overall fixture height (H) is measured from bottom of the glass shade to end of the coaxial cable.

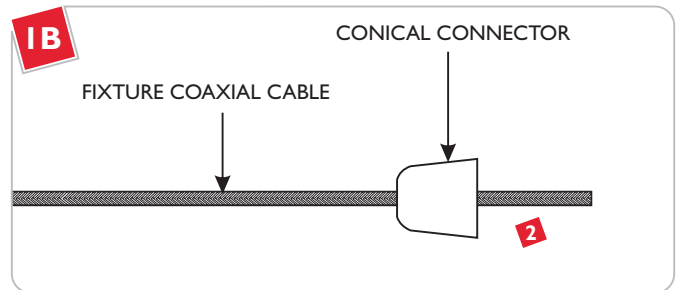

2 Insert the fixture coaxial cable through the conical connector.

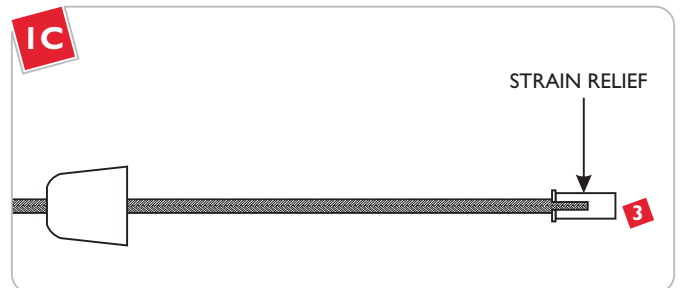

3 Insert the coaxial cable through the flared end of the strain relief.

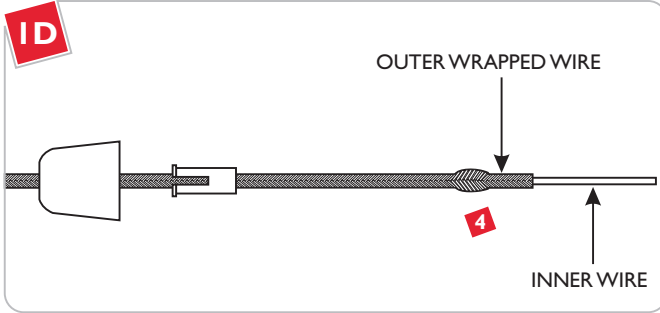

4 Slide the outer wrapped wire back to expose the inner wire.

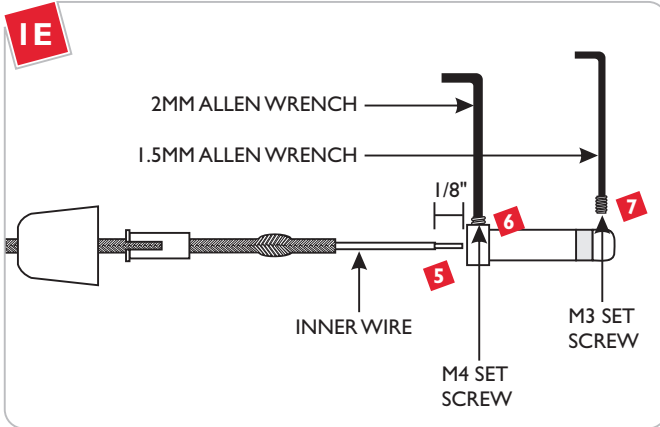

5 Strip 1/8" from end of the inner wire. **Make sure that the stripped portion is not greater than 3/16".**

6 Loosen (**Do Not Remove**) the M4 set screw with the provided 2MM Allen wrench.

7 Remove the M3 set screw with the provided 1.5MM Allen wrench.

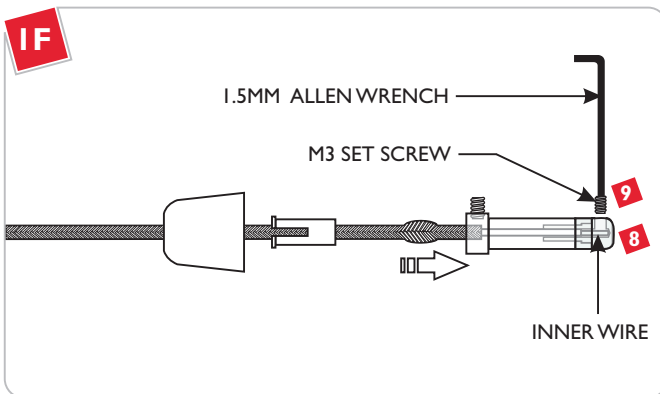

8 While inserting the inner wire into the connector look through the set screw hole to make sure that the stripped portion of the inner wire contacts end of the connector.

9 Hold the coaxial cable in place; replace and tighten the M3 set screw with the 1.5MM Allen wrench. **Lightly** tug on the coaxial cable to make sure that the set screw connection is tight.

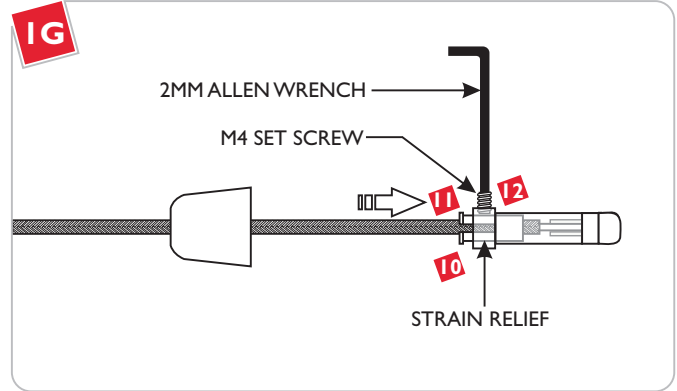

10 The strain relief slots should be rotated 90° away from the M4 set screw.

11 Slide and push the strain relief completely into the connector. This will force the outer wrapped wire to be inserted into the connector.

12 Tighten the M4 set screw with the 2MM Allen wrench so that the strain relief holds the outer wrapped wire in place.

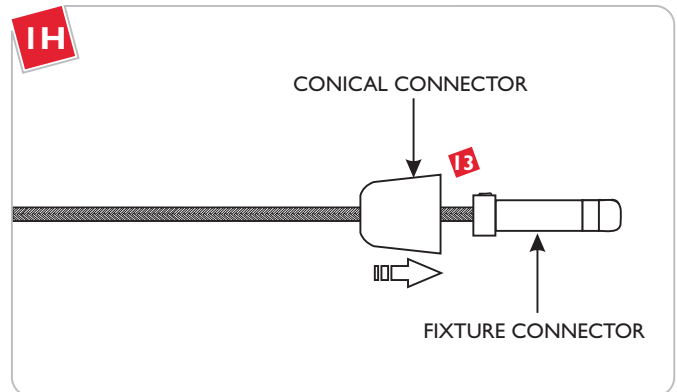

13 Slide the conical connector over the fixture connector. To install the fixture, refer to the instructions provided with the system.

Install the Lamp

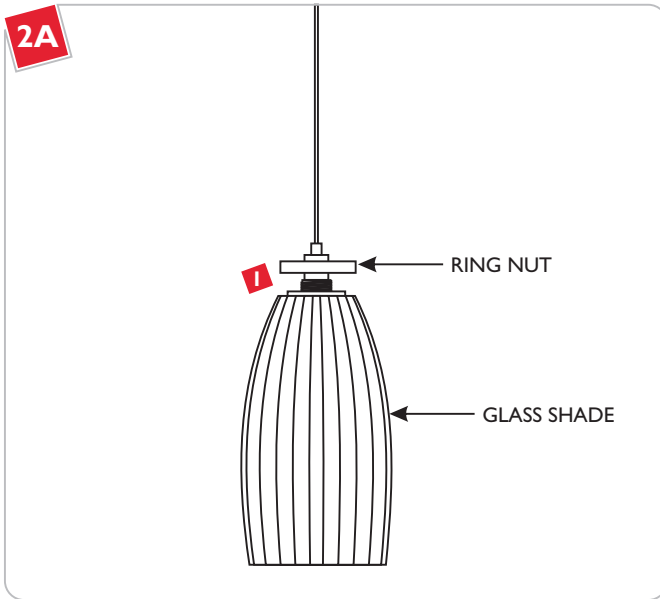

NOTE: To reduce the risk of a burn or electric shock during relamping, disconnect the power the fixture.

1 Unscrew the ring nut from the top of the glass shade.

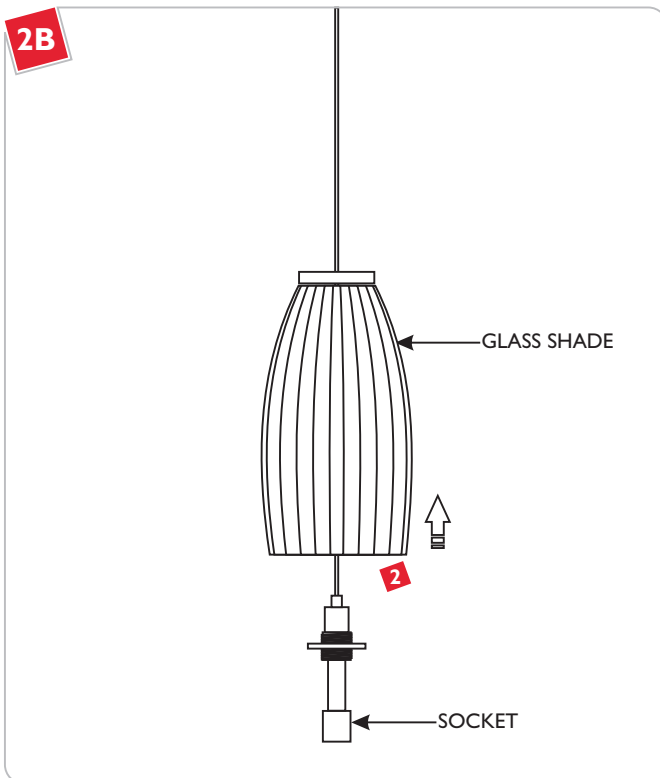

2 Lift the glass shade up to expose the socket.

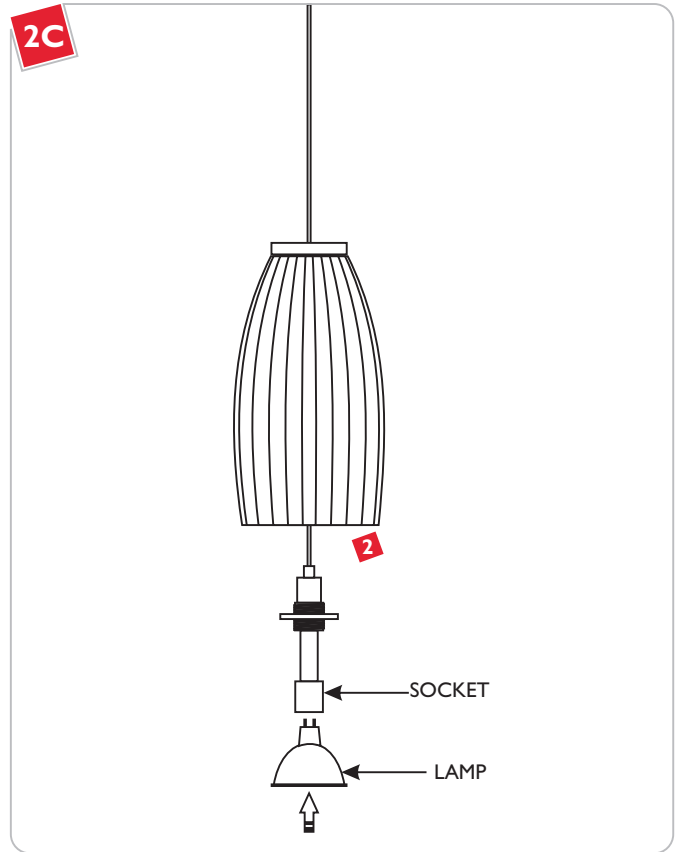

Use **MAX 50** Watt MR16 Front Cover Halogen Lamp.



3 Push the lamp pins completely into the socket holes.

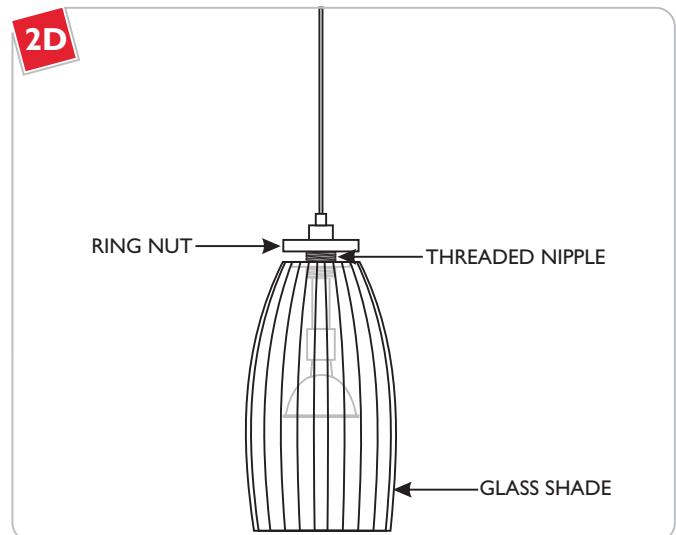

4 Lower the glass shade onto the socket assembly and tighten the ring nut to the socket assembly threaded nipple.

IMPORTANT SAFETY INSTRUCTIONS

To reduce the risk of fire, electrical shock, exposure to excessive UV radiation, or injury to person:

- Use this fixture indoors only.
- Do not look directly at the lighted lamp.
- Do not remain in light if skin feels warm.
- Risk of fire: Use only the type of lamp and maximum wattage indicated in this instruction manual.
- Never cover the halogen lamp with anything other than a LBL Lighting lamp shield and never place flammable material close to your fixture.
- Never turn the fixture on and off by connecting and disconnecting the halogen lamp.
- Do not touch the fixture shades or lamp shield while the fixture is on. These surfaces may be HOT.

Halogen Lamp General Information

– A new halogen lamp may smoke slightly when it is used for the first time. This is perfectly normal; the protective coating is simply being vaporized.

Two Tips For Prolonging Halogen Lamp Life

- First avoid touching the lamp with bare hands during installation. Any contaminant, even the oil from your hands can deteriorate the lamp. Rubbing alcohol can be used to remove any contaminant.
- Second, do not run the lamps at full power when you do not need to. However, if dimming the fixture for an extended period of time, occasionally bring the light up to full brightness for a few minutes to complete the halogen cycle.

SAVE THESE INSTRUCTIONS!



7400 Linder Ave, Skokie, IL 60077

800.323.3226 - 847.626.6300

www.lblighting.com

© 2008 LBL Lighting. All rights reserved. The "LBL Lighting" graphic is a registered trademark of LBL Lighting. LBL Lighting reserves the right to change specifications for product improvements without notification.

A Generation Brands Company