

# F/X Swivel

HD432\_IA50FSJ

1.0



Fusion Jack™

## GENERAL PRODUCT INFORMATION:



This product is ETL listed and suitable only for indoor dry locations and approved for use at any height above the finished floor.

Colored and Dichroic lenses, or Diffuser, Linear Spread, and Soft Focus Lenses, or Structure Louvers are the compatible accessories.

**WARNING: Risk of Fire. Hot Surface.** Install the fixture at least 6" (Inches) away from wall, curtains and combustible materials. Maintain at least 9" (Inches) of clearance directly in front of the fixture.

**AVERTISSEMENT: Risque du feu. Surface Chaude.** Installez le montage au moins 6" (Pouces), 153 mm, loin du mur, des rideaux et des matériaux combustibles. Maintenez au moins 9" (Pouces), 230 mm, de dégagement directement devant le montage.

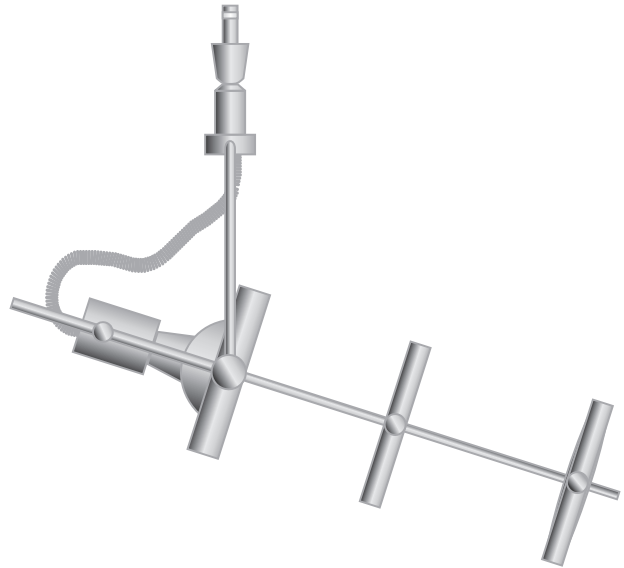

## Install the Lamp and Disc Holders

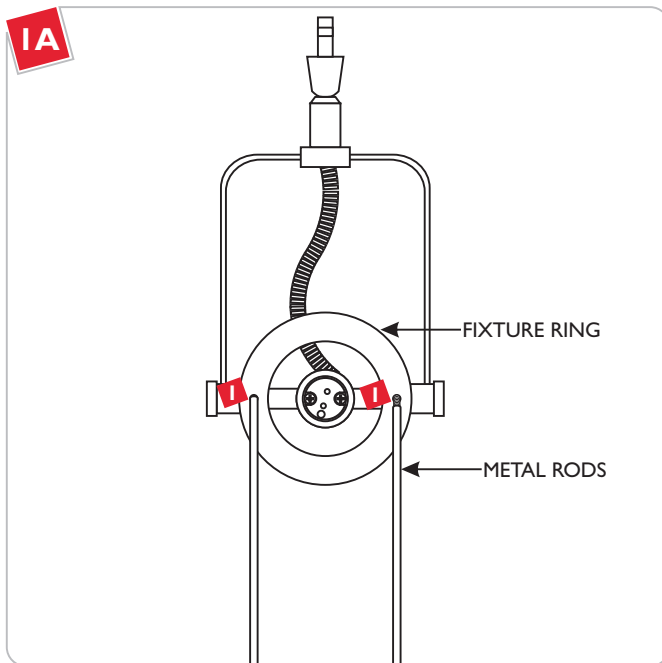

**1** Screw the two metal rods completely into the threaded holes of the fixture ring.

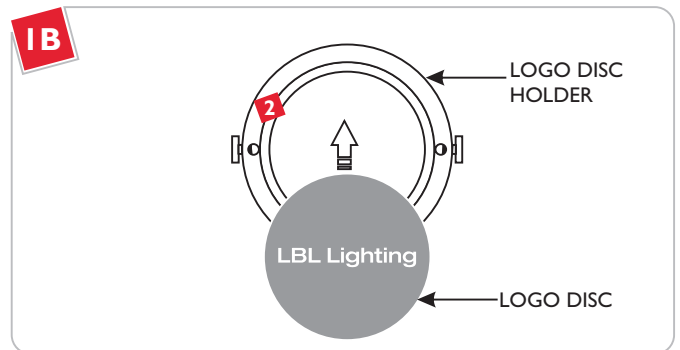

**2** Place the logo disc inside the disc holder.

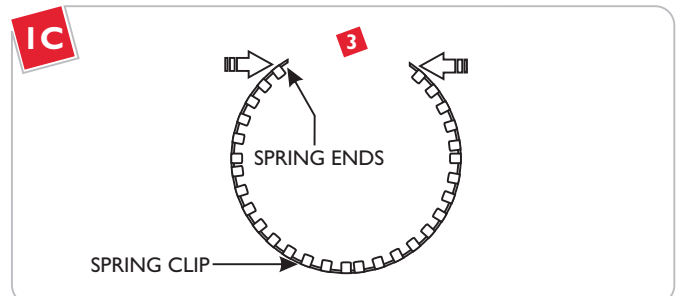

**3** Squeeze the spring clip ends towards each other.

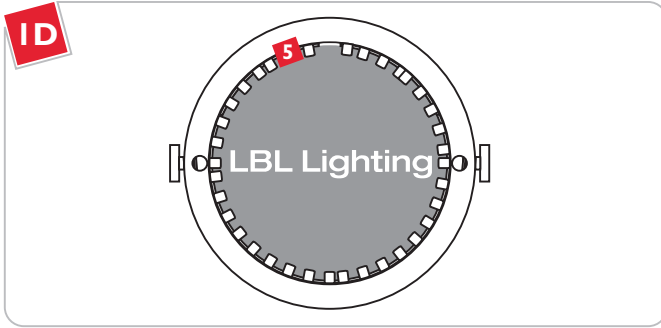

- 4 Place the spring clip properly in the front of the logo disc into the disc holder.
- 5 Release the spring clip ends to secure the logo disc in disc holder.

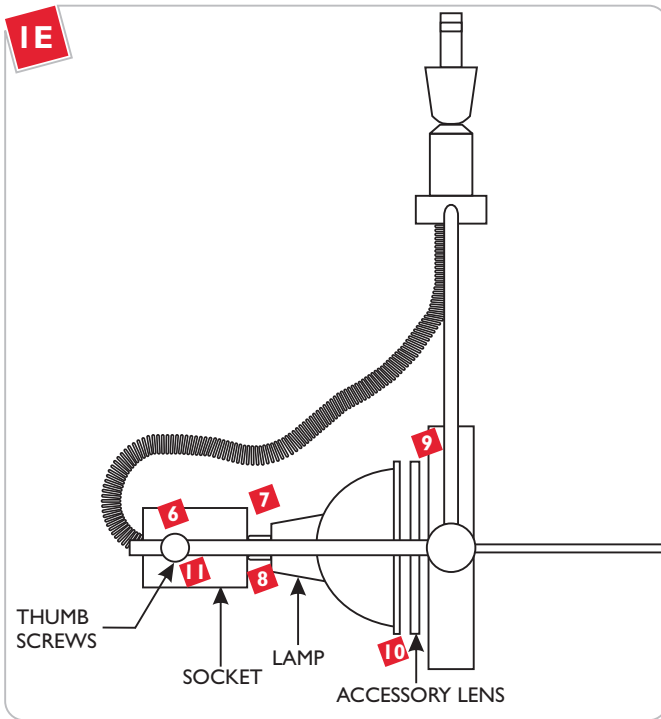

**NOTE:** To reduce the risk of a burn or electric shock during relamping, disconnect the power to the fixture.

- 6 Loosen the thumb screws on the socket.
  - 7 Slide the socket back.
- Use **MAX 50 Watt MR16 Front Cover Halogen Lamp.** 
- 8 Push the MR16 lamp pins completely into the socket holes.
  - 9 Put the optional accessory lens into the ring.
  - 10 Slide the socket forward so that the edge of the lamp sits inside the ring.
  - 11 Tighten the thumb screws on the socket.

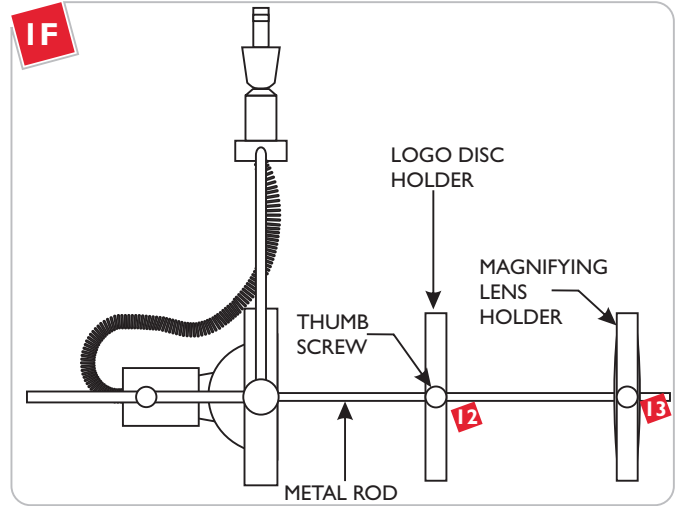

- 12 Place the logo disc holder onto the metal rods and tighten the thumb screws.
- 13 Place and slide the magnifying lens holder onto the metal rods and tighten the thumb screws.

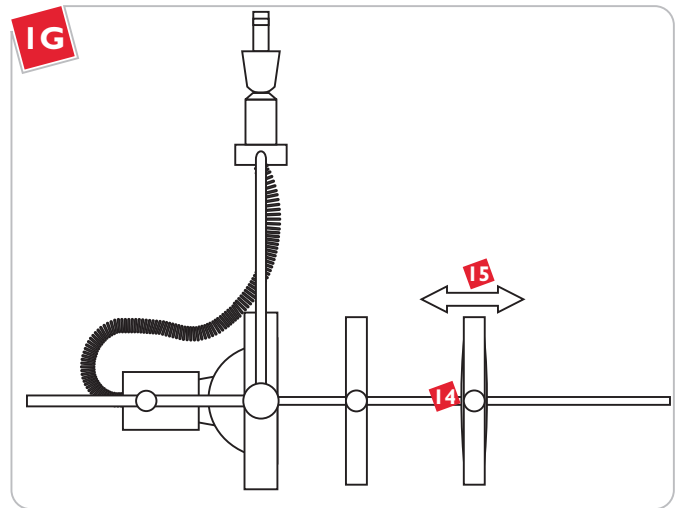

**NOTE:** The projected logo gets bigger and the intensity of the projected logo gets dimmer as the fixture is installed farther from the wall.

- 14 Loosen the thumb screws on the magnifying lens holder.
- 15 Focus the logo disc image by sliding the magnifying lens holder. When focused image is achieved, tighten the thumb screws.

## IMPORTANT SAFETY INSTRUCTIONS

**To reduce the risk of fire, electrical shock, exposure to excessive UV radiation, or injury to person:**

- Use this fixture indoors only.
- Do not look directly at the lighted lamp.
- Do not remain in light if skin feels warm.
- Risk of fire: Use only the type of lamp and maximum wattage indicated in this instruction manual.
- Never cover the halogen lamp with anything other than a LBL Lighting lamp shield and never place flammable material close to your fixture.
- Never turn the fixture on and off by connecting and disconnecting the halogen lamp.
- Do not touch the fixture shades or lamp shield while the fixture is on. These surfaces may be HOT.

## Halogen Lamp General Information

- A new halogen lamp may smoke slightly when it is used for the first time. This is perfectly normal; the protective coating is simply being vaporized.

### Two Tips For Prolonging Halogen Lamp Life

- First avoid touching the lamp with bare hands during installation. Any contaminant, even the oil from your hands can deteriorate the lamp. Rubbing alcohol can be used to remove any contaminant.
- Second, do not run the lamps at full power when you do not need to. However, if dimming the fixture for an extended period of time, occasionally bring the light up to full brightness for a few minutes to complete the halogen cycle.

**SAVE THESE INSTRUCTIONS!**



7400 Linder Ave, Skokie, IL 60077

800.323.3226 - 847.626.6300

[www.lblighting.com](http://www.lblighting.com)

© 2008 LBL Lighting. All rights reserved. The "LBL Lighting" graphic is a registered trademark of LBL Lighting. LBL Lighting reserves the right to change specifications for product improvements without notification.

A Generation Brands Company