

# Daisy

HS332\_IB50FSJ

1.1



## GENERAL PRODUCT INFORMATION:



This product is ETL listed and suitable only for indoor dry locations and approved for use at any height above the finished floor.



## Install the Lamp & Shade

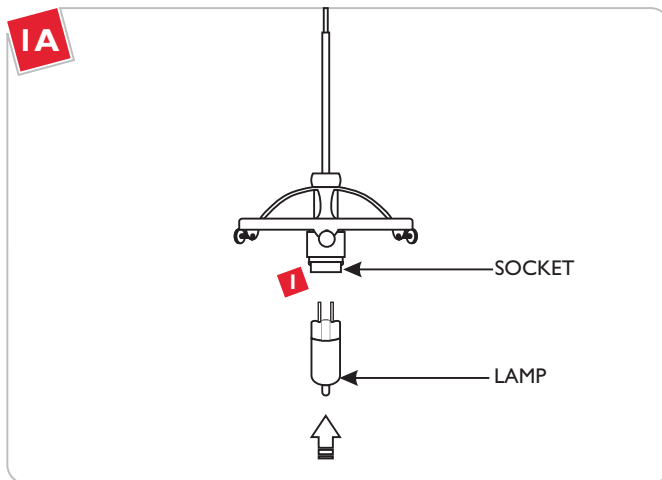

**NOTE:** To reduce the risk of a burn or electric shock during relamping, disconnect the power to the fixture.

**NOTE:** Use only your fingers and soft cloth to replace the lamp.

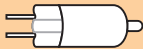
Use **MAX 50 Watt**, Type Xenogen (Xenon) Bi-Pin Lamp. 

**1** Push the lamp pins completely into the socket holes.

**WARNING: RISK OF FIRE**  
Never replace a Xenon (Xelogen) lamp with a regular Halogen lamp. A regular Halogen lamp requires a protective glass shield.

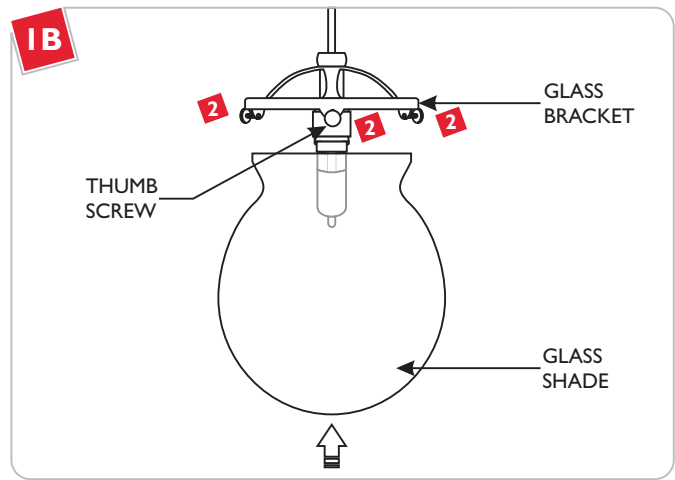

**2** Place the glass shade completely into the glass bracket and tighten the three thumb screws to secure the glass shade in place.

**NOTE:** Do not over tighten the thumb screw which may cause the glass shade to break.

## Adjust the Fixture Height

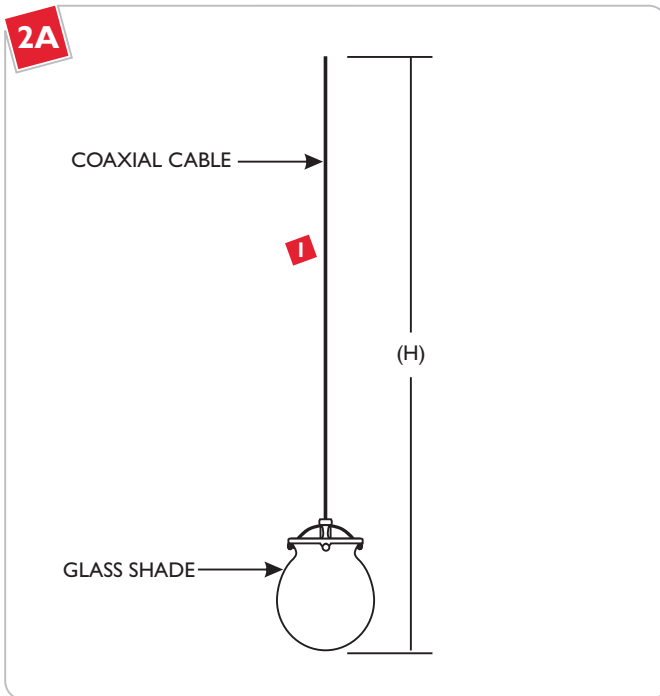

- 1** Cut the coaxial cable to the desired length with a sharp cutter. The overall fixture height (H) is measured from bottom of the glass shade to the end of the coaxial cable.

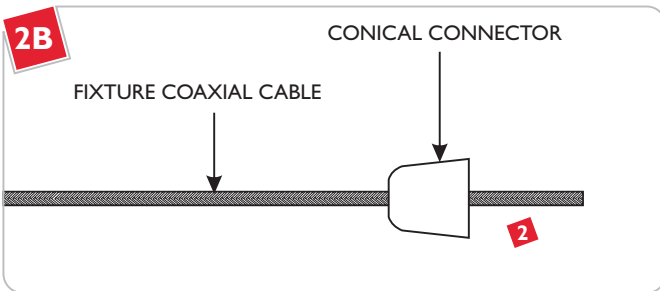

- 2** Insert the fixture coaxial cable through the conical connector.



- 3** Insert the coaxial cable through the flared end of the strain relief.

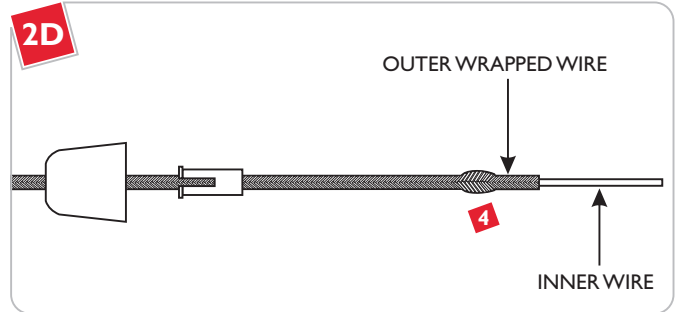

- 4** Slide the outer wrapped wire back to expose the inner wire.

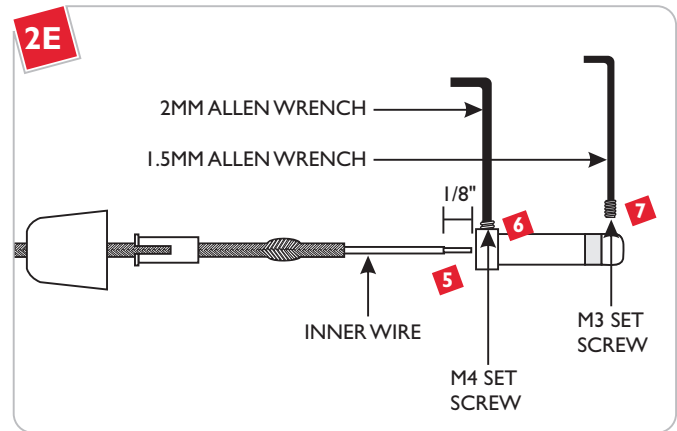

- 5** Strip 1/8" from end of the inner wire. **Make sure that the stripped portion is not greater than 3/16".**
- 6** Loosen (**Do Not Remove**) the M4 set screw with the provided 2MM Allen wrench.
- 7** Remove the M3 set screw with the provided 1.5MM Allen wrench.

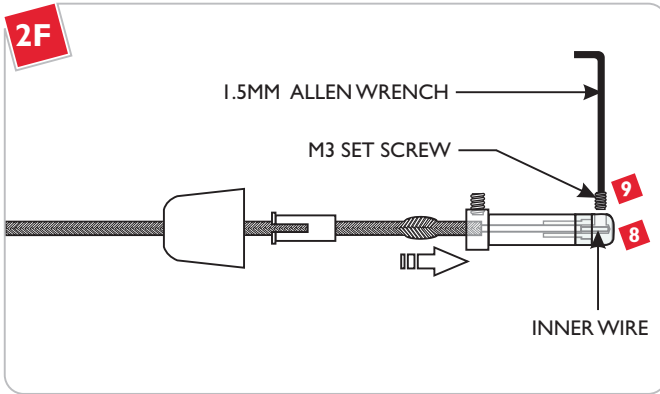

- 8 While inserting the inner wire into the connector look through the set screw hole to make sure that the stripped portion of the inner wire contacts end of the connector.
- 9 Hold the coaxial cable in place; replace and tighten the M3 set screw with the 1.5MM Allen wrench. **Lightly** tug on the coaxial cable to make sure that the set screw connection is tight.

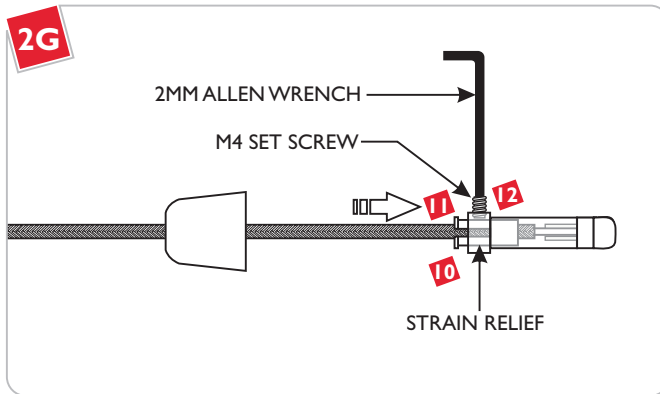

- 10 The strain relief slots should be rotated 90° away from the M4 set screw.
- 11 Slide and push the strain relief completely into the connector. This will force the outer wrapped wire to be inserted into the connector.
- 12 Tighten the M4 set screw with the 2MM Allen wrench so that the strain relief holds the outer wrapped wire in place.

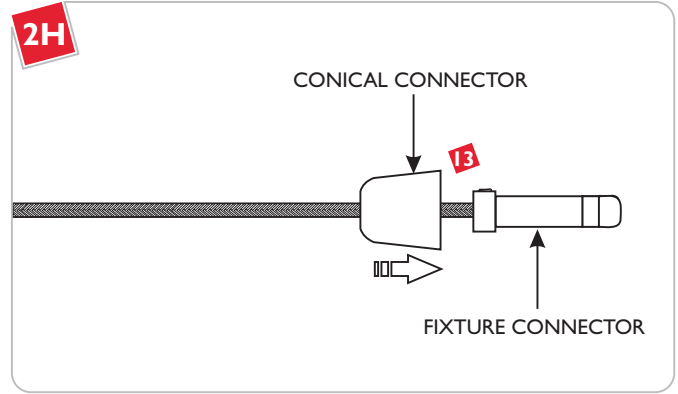

- 13 Slide the conical connector over the fixture connector. To install the fixture, refer to the instructions provided with the system.

**SAVE THESE INSTRUCTIONS!**



7400 Linder Ave, Skokie, IL 60077

800.323.3226 - 847.626.6300

[www.lblighting.com](http://www.lblighting.com)

© 2008 LBL Lighting. All rights reserved. The "LBL Lighting" graphic is a registered trademark of LBL Lighting. LBL Lighting reserves the right to change specifications for product improvements without notification.

A Generation Brands Company