

# HALO SELECT™

WI-FI AND MATTER ENABLED SMART LOCK



Installation and Reference Guide

# Welcome to the Kwikset family!

This guide will get you up and running with your new Halo Select.

If you have any issues, please visit our support center: [kwikset.com/support](https://www.kwikset.com/support) or call us at 1-800-327-5625.

# Getting started

For an interactive version of this installation guide, please download the Kwikset app:



[kwikset.com/app](https://kwikset.com/app)





# Table of contents

Parts in the box .....	4
Required tools .....	5
Installation .....	7
Download the app .....	17
Reference guide .....	19

# Parts in the box

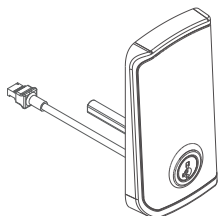

Exterior assembly

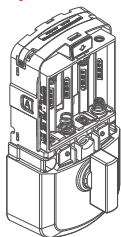

Interior assembly

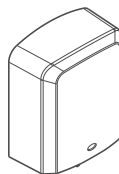

Interior cover

## Box 1

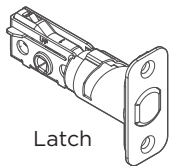

Latch



Batteries

## 03809

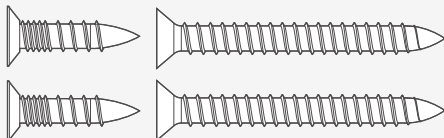

## Box 2



Door sensor magnet

Strike



## 46780

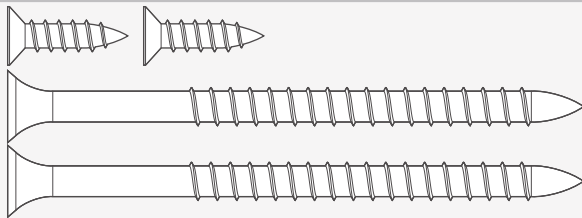

Box 3



Mounting plate

64844

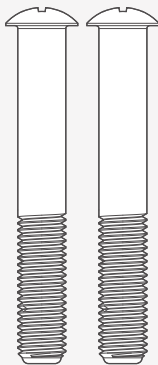

52502



Keys



SmartKey™  
tool

## Required tools



Phillips head  
screwdriver

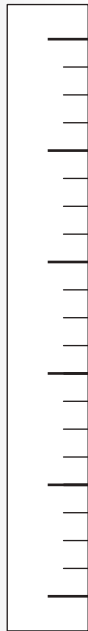

Ruler



No electric drills

# Installation





## Measure door thickness

1-3/4" to 2"  
(44mm - 51mm)

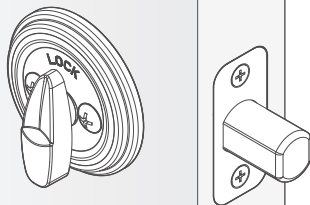

If door thickness is greater than 2" (51mm) contact Kwikset customer service at 1-800-327-5625. Your installation will require a thick door installation kit.

# ! Remove your existing deadbolt

Your new lock will only support a door thickness of 1-3/4" to 2" (44mm to 51mm) and a door bore hole diameter of 2-1/8" (54mm).

1-3/4" to 2"  
(44mm - 51mm)

2-1/8"  
(54mm)

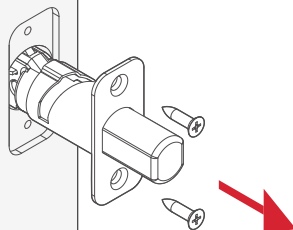
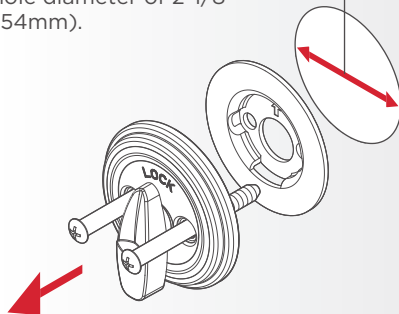
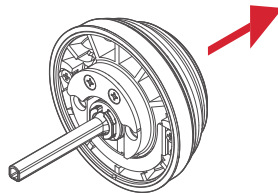

If drilling a new door, use the supplied template and instructions available at: [kwikset.com/doorprep](http://kwikset.com/doorprep)

# 1 Install the latch

A Extend the latch bolt.

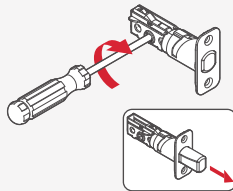

B UP is on top.

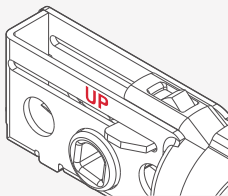

C If the D-shaped hole is not centered in the bore hole, rotate the latch face to extend the latch.

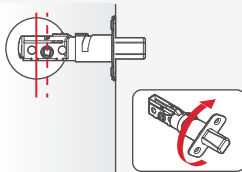

⚠ If your door requires a drive-in latch, please contact Kwikset at 1-800-327-5625.

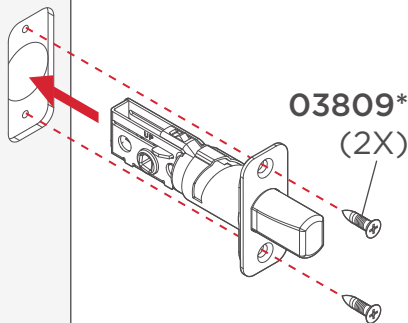
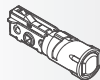

\*Use the longer screws if the holes are worn out.

You will have two extra screws.

## 2 Install the strike and sensor magnet

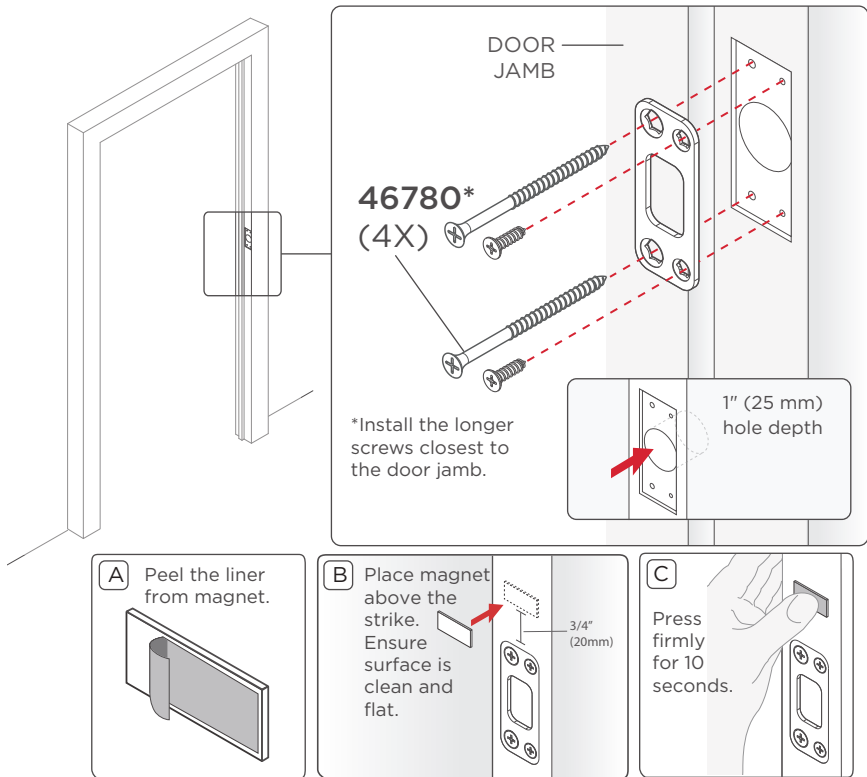

### 3 Install the exterior assembly

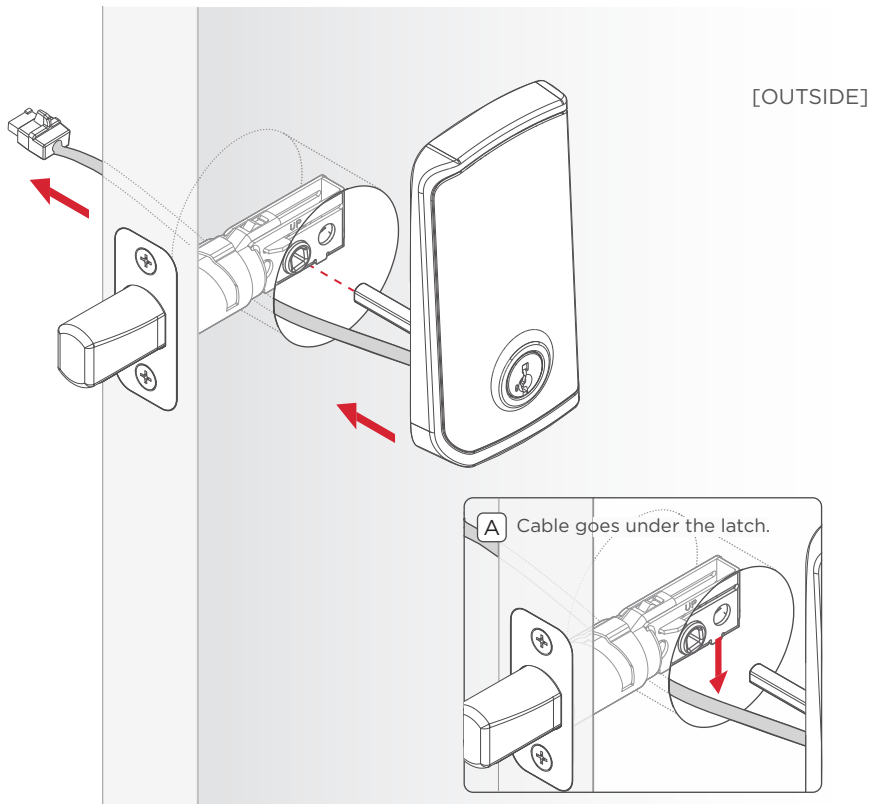

[INSIDE]

Keep parallel to  
the door edge

Tighten the screws evenly.  
**DO NOT** over-tighten.



**64844**  
(2X)

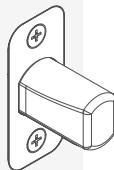
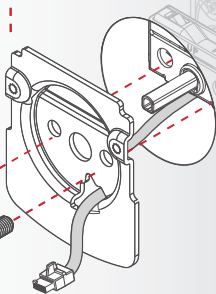
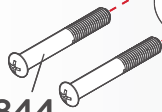

- B** Route the cable through the bottom hole of the mounting plate.

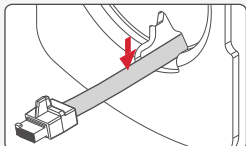

- C** Insert the key and test the latch. If the latch does not extend or retract smoothly, adjust the screws.

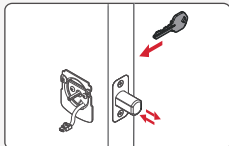

## 4 Install the interior assembly

-  Make sure to remove the battery pack before installing interior assembly. Press down on tab to release the battery pack, and pull out.

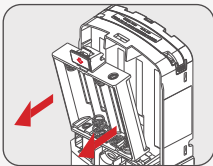

- A** If the turnpiece is not pointing up, rotate the turnpiece until it's in a vertical position.



Remove the interior cover from the interior assembly.

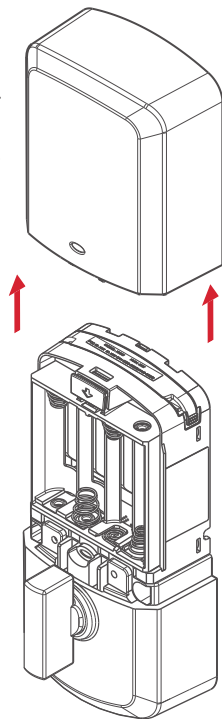

- B** Connect the cable.  
Ensure a tight cable  
connection.

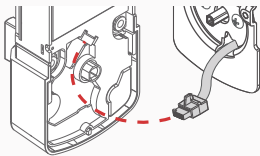

- C** Lay cable flat inside the  
bottom of the interior  
housing.

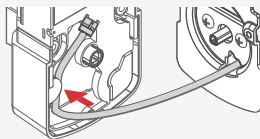

- D** Ensure the spindle  
fully engages with the  
turnpiece shaft.

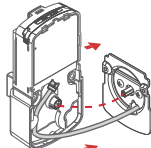

- ⚠** Ensure cable remains  
connected.

Secure the interior  
assembly onto the  
mounting plate.

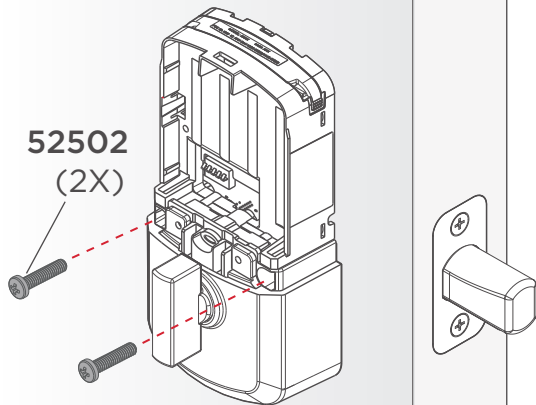

[INSIDE]



## 5 Install batteries and battery pack

- A** Insert (4) AA batteries (included) into the battery tray.

⚠ Ensure correct polarity. Use new, non-rechargeable alkaline batteries only.

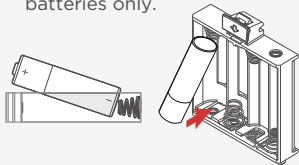

- B** Ensure bottom tabs of the battery pack are placed in the slots of the interior assembly before fully inserting battery pack. Battery pack should be flush after installation if inserted properly.

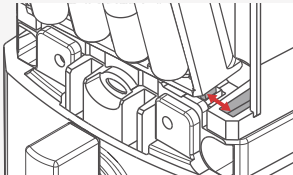

With the door open, install the battery pack. **NOTE: Lock must be installed on the door before inserting the batteries.**

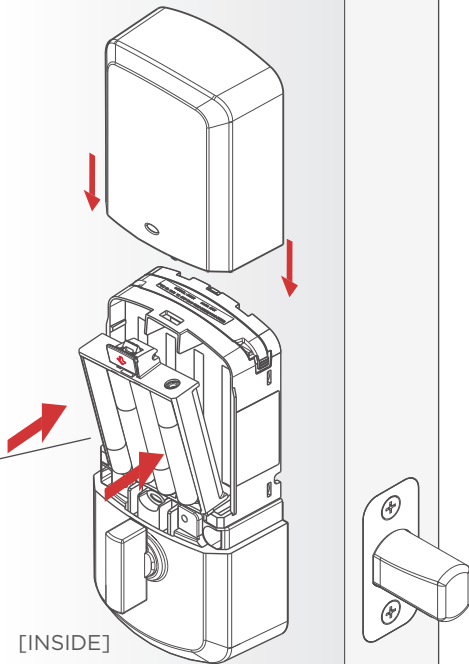

Download the Kwikset  
app & create an account  
to complete set up

# Complete your lock set up

Follow the set up instructions in the Kwikset app to complete your lock set up.



[kwikset.com/app](https://kwikset.com/app)



The Kwikset app is needed to use this lock. If this lock was professionally installed (or installed by someone other than the homeowner), make sure this step is performed by the homeowner.

# Reference Guide

## Locked

To lock your door, press the lock icon. The bolt will extend, then the screen will display the Locked LED Indicator and play the locked tone.

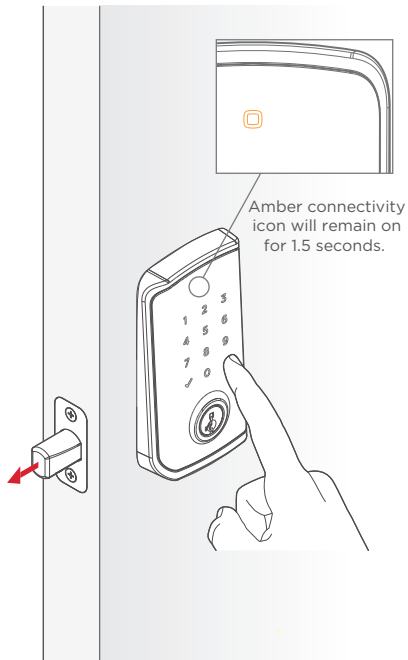

## Unlocked

To unlock your door, enter your access code. The bolt will retract, then the screen will display the Unlocked LED Indicator and play the unlocked tone.

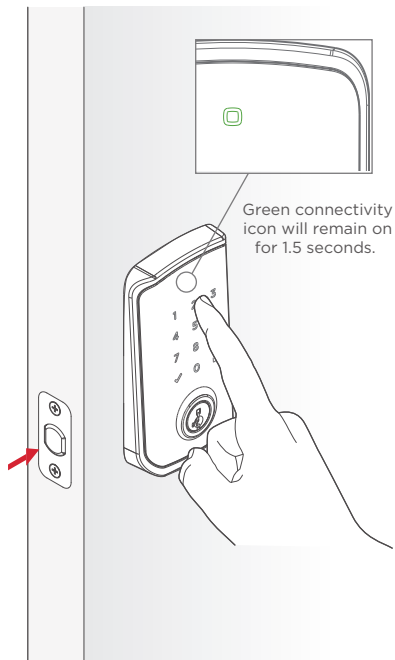

## SmartKey® Re-key

Re-key the lock to work with your existing key by following the [SmartKey® Re-key instructions](#).

**NOTE:** If Auto-Lock is enabled, remove the battery pack before re-keying your lock.

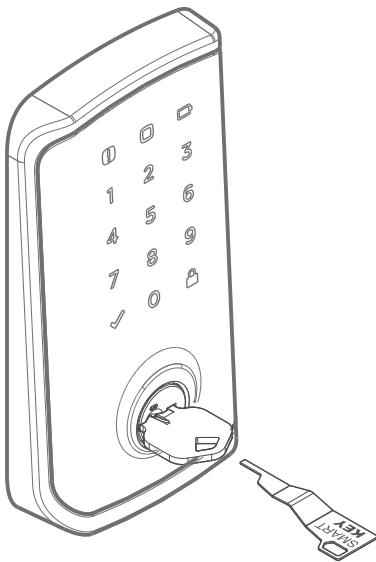

# Exterior LED Indicators

**Amber:**  
Locked



**Green:**  
Unlocked



**Alternating  
Red flashing:**  
Lock Jammed



**Red:**  
Low Battery



**Red:**  
Invalid Credentials



**Red:**  
Lockout



# Interior Status LED Indicators

**Green**

**Slow Blinking:**

Unlocked



**Amber**

**Slow Blinking:**

Locked

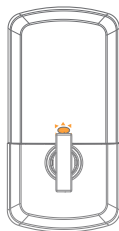

**Red**

**Blinking:**

Low Battery

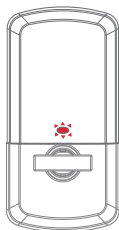



# Factory Reset

Factory Reset will:

- delete all access codes and associated schedule
- reset lock settings to default
- lock will show as offline in the Kwikset App
- lock will be deactivated and will need to be set up as new

Factory Reset should be used when:

- you want to change the lock owner
- you have lost your phone
- you are troubleshooting the lock

1. Remove the battery pack, then press and hold the Programming Button.

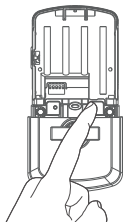

2. While still holding the Programming Button, insert the battery pack. Continue holding the Programming Button for 30 seconds.

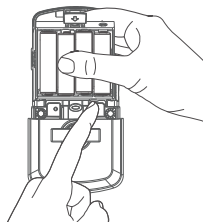

Continue to the next page for additional steps.

3. After 30 seconds, the Status LED light will flash RED and lock will beep. Release the Programming Button.

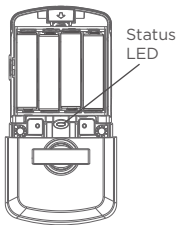

4. Press the Programming Button once within 5 seconds of the Status LED light displaying RED to confirm factory reset.

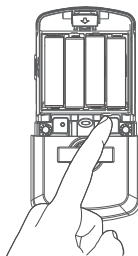

5. **SUCCESS:** Lock will play a series of beeps, Status LED will flash GREEN, then pulsing BLUE.

**UNSUCCESSFUL:** Lock will play a single-tone sound, Status LED light will flash RED.

# Halo Select at a Glance

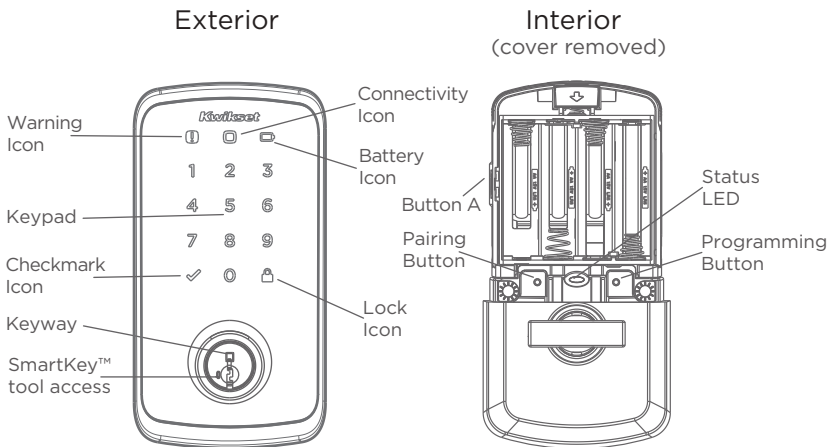

## Troubleshooting

If you have any issues, please visit our support center: [kwikset.com/support](https://kwikset.com/support) or call us at **1-800-327-5625**.



# Important Safeguards

1. Read all instructions in their entirety.
2. Familiarize yourself with all warning and caution statements.
3. Remind all family members of safety precautions.
4. Always have access to your lock's standard key.
5. If using the Auto-Lock features, make sure you have your smartphone or standard key with you to prevent locking yourself out.
6. Familiarize yourself with all light bar error notifications.
7. Replace low batteries immediately.
8. Dispose of used batteries according to local laws and regulations.

**⚠ WARNING:** This Manufacturer advises that no lock can provide complete security by itself. This lock may be defeated by forcible or technical means, or evaded by entry elsewhere on the property. No lock can substitute for caution, awareness of your environment, and common sense. Builder's hardware is available in multiple performance grades to suit the application. In order to enhance security and reduce risk, you should consult a qualified locksmith or other security professional.

# Regulatory Compliance

This product complies with standards established by the following regulatory bodies:

- Federal Communications Commission (FCC)
- Industry Canada

## FCC

This device complies with Part 15 of the FCC Rules. Operation is subject to the following two conditions: (1) this device may not cause harmful interference, and (2) this device must accept any interference received, including interference that may cause undesired operation. This equipment has been tested and found to comply with the limits for a Class B digital device, pursuant to Part 15 of the FCC Rules. These limits are designed to provide reasonable protection against harmful interference in a

residential installation. This equipment generates, uses, and can radiate radio frequency energy and, if not installed and used in accordance with the instructions, may cause harmful interference to radio communications. However, there is no guarantee that interference will not occur in a particular installation. If this equipment does cause harmful interference to radio or television reception, which can be determined by turning the equipment off and on, the user is encouraged to try to correct the interference by one or more of the following measures:

- Reorient or relocate the receiving antenna.
- Increase the separation between the equipment and receiver.

- Connect the equipment into an outlet on a circuit different from that to which the receiver is connected.
- Consult the dealer or an experienced radio/TV technician for help.

**IMPORTANT!** Changes or modifications not expressly approved by the manufacturer could void the user's authority to operate the equipment.

## Industry Canada

This device contains licence-exempt transmitter(s)/receiver(s) that comply with Innovation, Science and Economic Development Canada's licence-exempt RSS(s). Operation is subject to the following two conditions: (1) This device may not cause interference. (2) This device must accept any interference, including interference that may cause undesired operation of the device.

FCC ID: NUL-HAL3S  
IC: 3022A-HAL3S