











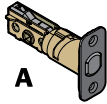
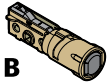

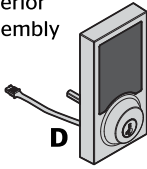

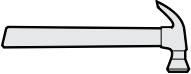

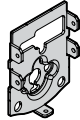
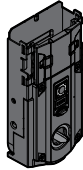
Premis™

TOUCHSCREEN SMART LOCK

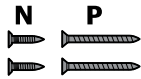
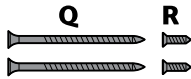
Required tools	Parts in the box					
Ruler  Phillips screwdriver 	Latch with rectangular faceplate  A	Drive-in latch  B	Strike  C	Exterior assembly  D	Adapter ring  E	Keys  F
Additional tools (depending on application) Hammer  Wood block 	Mounting plate  G	Interior assembly  H	Battery pack  J	Interior cover  K	Batteries  L	SmartKey tool  M
Latch screws  N P 03809		Strike screws  Q R 46780		Mounting plate screws  S 48654	Interior assembly screws  U 49191	Interior cover screws  V 64109

Note: Part numbers are printed on screw bags.

1 Prepare the door and check dimensions

If drilling a new door, use the supplied template and the complete door drilling instructions available at www.kwikset.com/doorprep.

- A** Measure to confirm that the hole in the door is either 2-1/8" (54 mm) or 1-1/2" (38 mm).

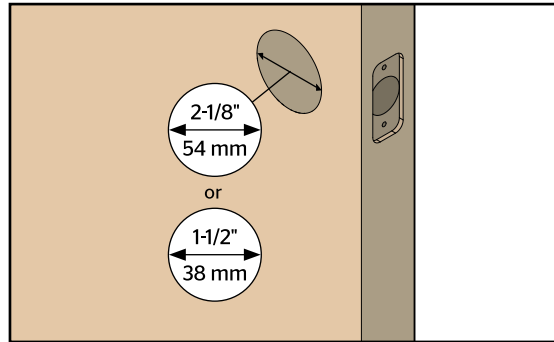

Note: Additional door preparation may be required for doors with 1-1/2" (38 mm) holes. Consult the deadbolt drilling instructions at www.kwikset.com/doorprep

- B** Measure to confirm that the backset is either 2-3/8" or 2-3/4" (60 or 70 mm).

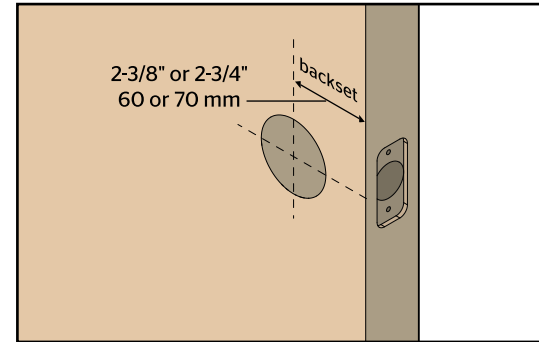

- C** Measure to confirm that the hole in the door edge is 1" (25 mm).

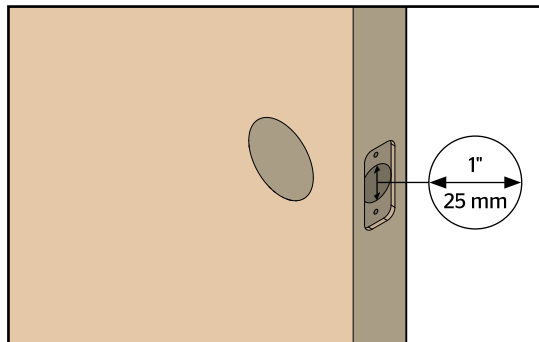

- D** Measure to confirm that the door is between 1-3/8" and 2" (35 mm and 51 mm) thick.

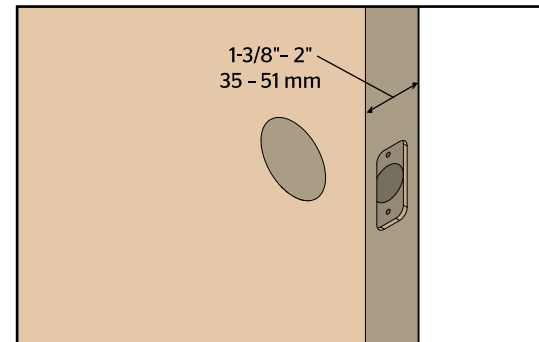

2

Install the latch and strike

A Is the door edge chiseled?

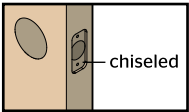
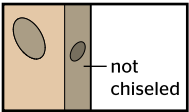
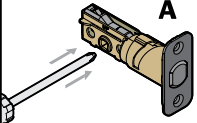
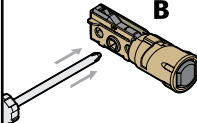
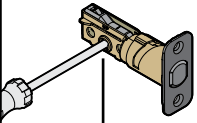
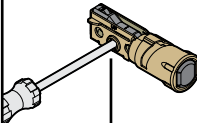
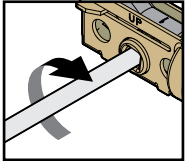
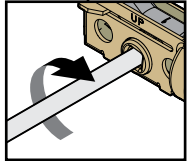
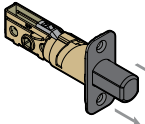
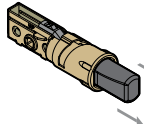
YES	OR	NO
		
Use latch "A". If the latch bolt is not already extended, extend the latch bolt as shown.		Use latch "B". If the latch bolt is not already extended, extend the latch bolt as shown.
		
		
		
		

B Hold the latch in front of the door hole, with the latch face flush against the door edge.

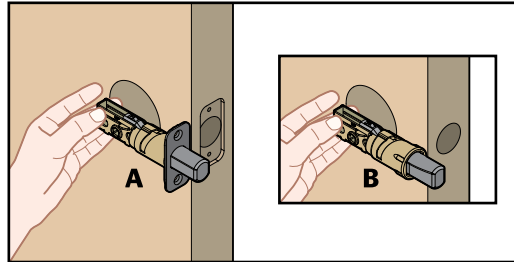

C Is the D-shaped hole centered in the door hole?

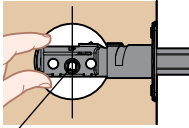
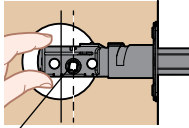
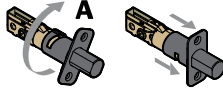
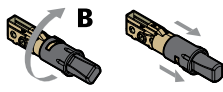
YES	OR	NO
		
D-shaped hole centered		D-shaped hole NOT centered
No adjustment is required. Proceed to next step.		Rotate latch face as shown to extend latch.
		
		

D Which latch are you installing?

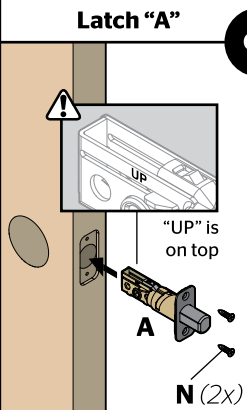
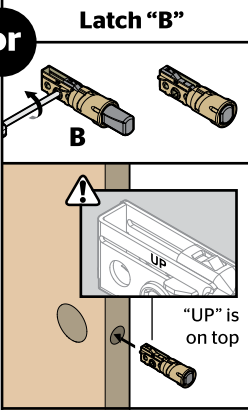
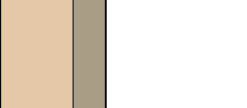
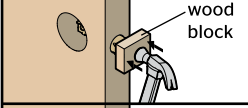
Latch "A"	OR	Latch "B"
		
"UP" is on top		"UP" is on top
		
N (2x)		wood block

E Install strike on the door frame.

⚠ Make sure the hole in the door frame is drilled a minimum of 1" (25 mm) deep.

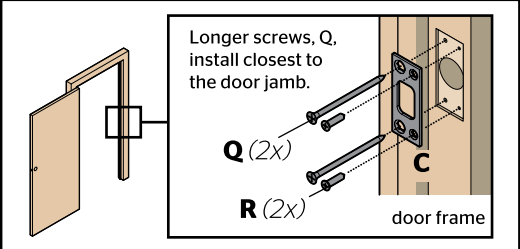

Longer screws, Q, install closest to the door jamb.

Q (2x)



R (2x)

door frame

Note: The longer screws, Q, (3" / 76 mm) must be used to maintain highest security.

3 Install the exterior assembly

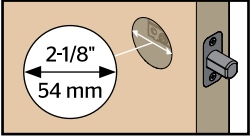
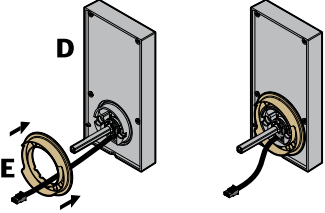
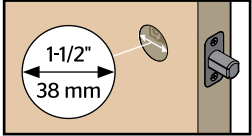
A What is the diameter of the hole in the door?

<p>Diameter is 2-1/8" (54 mm)</p>  <p>"E" is required for installation. Install "E" on "D".</p> 	<p>or</p>	<p>Diameter is 1-1/2" (38 mm)</p>  <p>"E" is not needed for installation. Discard "E".</p> 
---	------------------	--

B Locate screws for step 3C and keep them within reach.

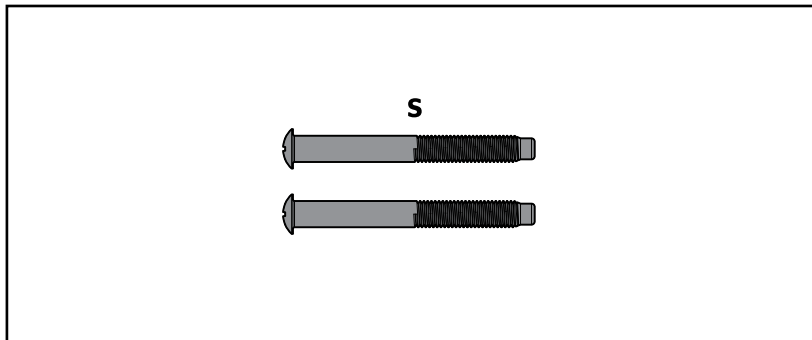

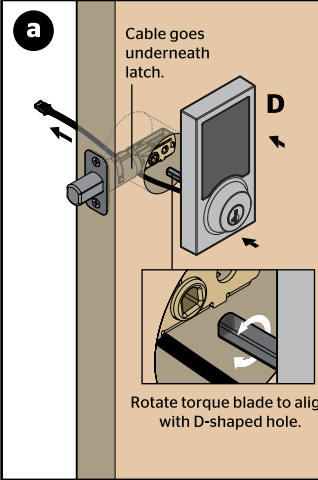
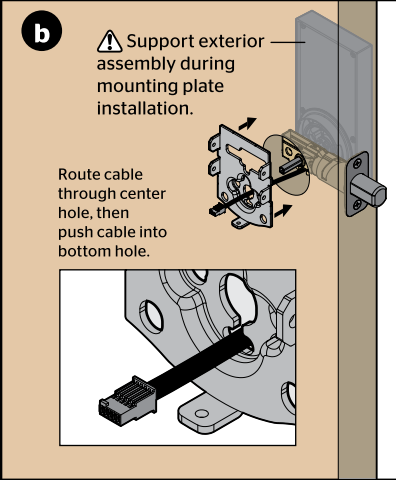
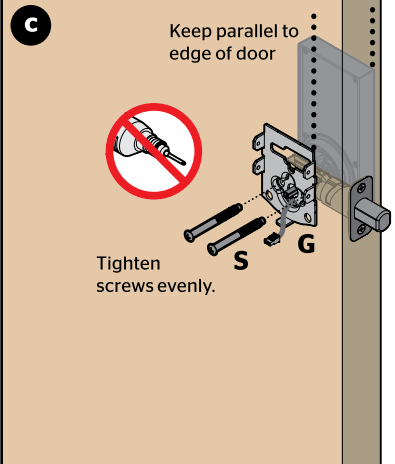
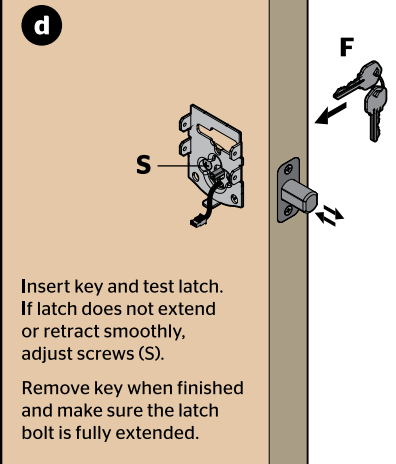

C Install exterior assembly and mounting plate.

<p>a</p>  <p>Cable goes underneath latch.</p> <p>Rotate torque blade to align with D-shaped hole.</p>	<p>b</p>  <p>⚠ Support exterior assembly during mounting plate installation.</p> <p>Route cable through center hole, then push cable into bottom hole.</p>
<p>c</p>  <p>Keep parallel to edge of door</p> <p>Tighten screws evenly.</p>	<p>d</p>  <p>Insert key and test latch. If latch does not extend or retract smoothly, adjust screws (S).</p> <p>Remove key when finished and make sure the latch bolt is fully extended.</p>

4 Install the interior assembly

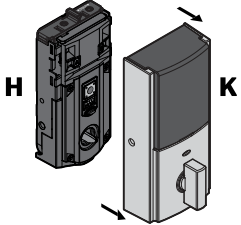
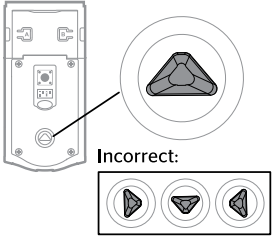
A Ensure the turnpiece shaft is pointing up, and remove the interior cover and battery pack from the interior assembly.

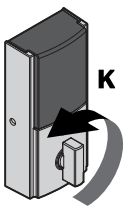
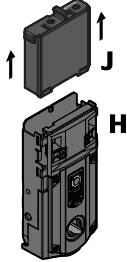
<p>a Remove the interior cover from the interior assembly.</p> 	<p>b Make sure turn piece shaft is rotated as shown.</p>  <p>Incorrect:</p>  <p>If turnpiece shaft is not oriented correctly, put the cover back on and rotate the turnpiece as shown in step C.</p>	<p>c If the turnpiece shaft is pointing down, place the cover back onto the interior assembly and rotate the turnpiece until you hear it click. You may need to apply some force. Once the turnpiece shaft is correctly oriented, remove the cover again.</p> 	<p>d</p>  <p>Do not install batteries yet.</p>
---	---	--	--

B Connect cables and install interior assembly.

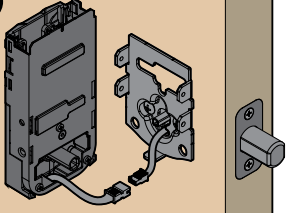
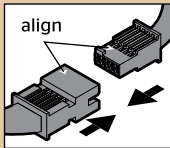
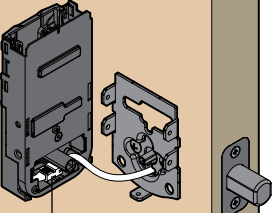
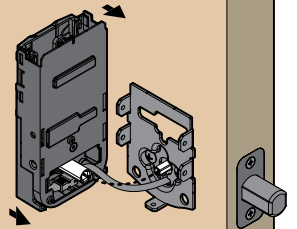
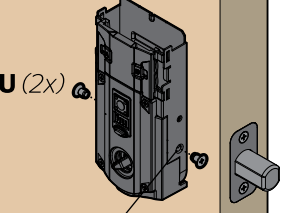
<p>a</p>  <p>Ensure tight cable connection.</p>  <p>align</p>	<p>b</p>  <p>Lay excess cable flat inside the bottom of the interior housing.</p>	<p>c</p>  <p>Push turnpiece shaft onto torque blade.</p> <p>turnpiece shaft torque blade</p>	<p>d Secure with screws.</p>  <p>U (2x)</p> <p>bottom hole</p>
---	--	---	---

5 Perform the door handing process

This step will teach the lock the orientation of your door and is crucial for lock operation.

A Install 4 AA batteries in the battery pack.

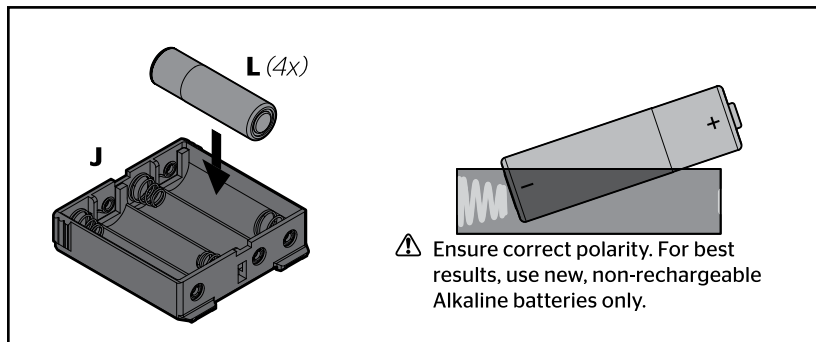

B Make sure the door is open. Insert the battery pack.

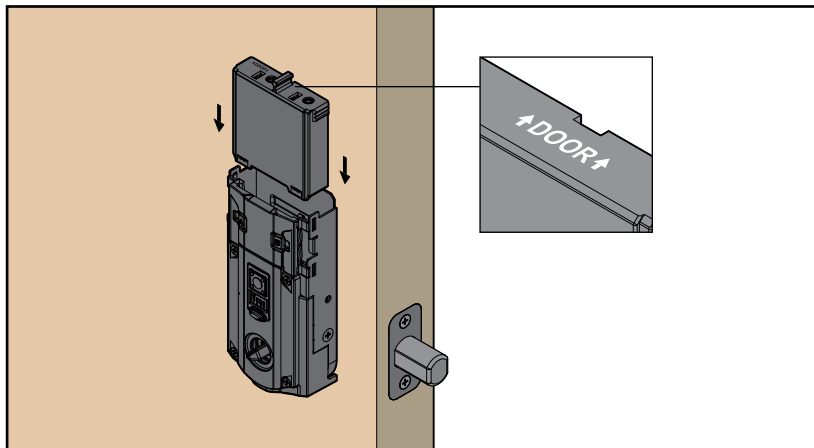

C After a few seconds, the latch bolt will retract and extend on its own to learn the orientation of the door. This is called the **door handing process**, and it is crucial to lock operation.

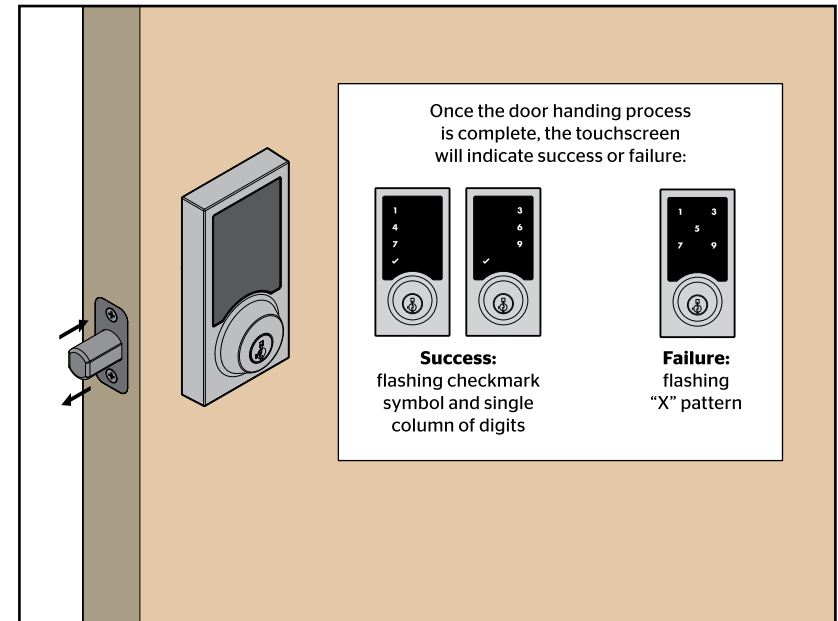

D If the touchscreen indicates a failure, perform the manual door handing procedure on page 10.

If the door handing process is still unsuccessful, consult the online User Guide at www.kwikset.com/support/guides/premis-user.

6 Install the interior cover

Important information about the interior cover:

The interior cover will be secured by three screws to prevent someone from removing the battery or tampering with your lock's setting.

The window on the interior cover is locked by default.

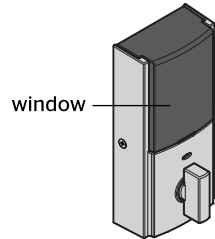

If the window is unlocked, it can slide up for more convenient access to the programming buttons and the battery pack while the cover is installed.

Note: The interior cover and battery pack access.

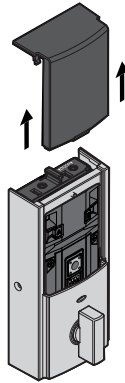

Cover Installation:

a If you want to unlock the window, remove the security screw.

Skip to step b if you want to keep the window locked.

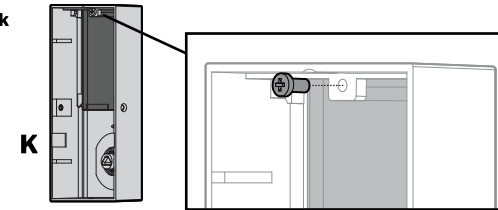

b Install the interior cover.

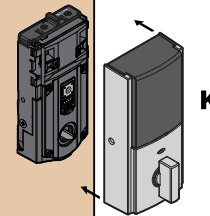

c Secure the interior cover with three (3) screws.

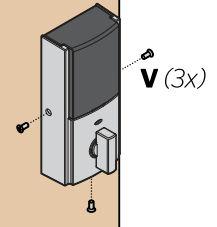

7 OPTIONAL: Re-key the lock

If desired, the lock may be re-keyed to work with your existing key. See the supplied SmartKey Re-key instructions for more information.

8 Download the Premis app and pair your lock to your phone

A Download the Premis app from the App Store.

B Follow the instructions inside the app to pair your smartphone, manage the settings of your lock, and send user codes to family and friends.

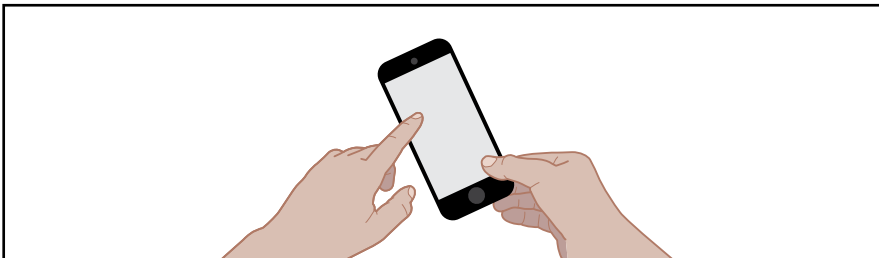

Compatibility

HomeKit™ requires an iPhone®, iPad® or iPod touch® with iOS 10.3 or later.

Controlling HomeKit-enabled accessories away from home requires an Apple TV® (4th generation or later) with Apple TV® OS 10.2 or later and an iPhone®, iPad® or iPod touch® with iOS 10.3 or later.

For best results, lock should be within 40 feet of an Apple TV® for remote capability.

Premis at a Glance

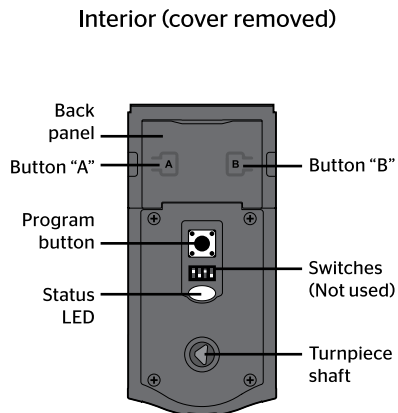
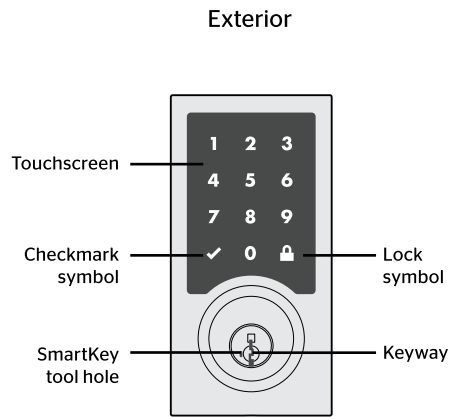

Note: When the cover is removed, the turnpiece shaft can be used to manually lock and unlock the door.

Locking and Unlocking

With the Premis App

When you are within Bluetooth range of your lock, you can use Siri commands to lock and unlock your door. Make sure your phone is unlocked, and refer to your lock by the name you assigned to it inside the Premis app. You can also tap the symbol of your lock inside the Premis app to lock and unlock the door.

If you have an Apple TV (4th generation or later), you can lock and unlock the door when you're away from home. Just sign in to iCloud with the same Apple ID on your phone and Apple TV.

Note: Remote locking and unlocking functionality will be disabled if your Apple TV goes to sleep. It is recommended that you disable your Apple TV's sleep mode inside your Apple TV's settings.

With the Touchscreen

To lock and unlock your door with the Premis touchscreen, **you must have at least one user code programmed.** It is recommended that you add your user codes from inside the Premis app. If you would like to add them directly at the lock, follow the instructions at www.kwikset.com/support/guides/premis-user.

Locking the Door

1. Activate the screen.
2. Press Lock symbol.

Note: If no user codes are programmed, the door cannot be locked via touchscreen.

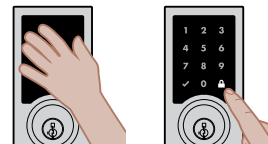

Unlocking the Door

1. Activate the screen.
2. If SecureScreen™ is enabled, touch the random digits that appear.
3. Enter user code.

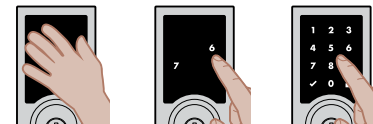

If you press the wrong digit while entering a user code, you can press the Lock symbol once to clear the digits entered previously and immediately restart the code entry process.

Auto-Lock

The Auto-Lock feature automatically re-locks your door 30 seconds after unlocking. This feature is off by default, but you may enable it inside the Premis app. You may also adjust the time delay (between 30 seconds and 4 minutes) within the app.

Activating the Screen

Option 1

Touch screen with palm or back of hand until digits illuminate.

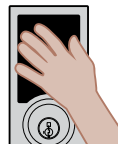

Option 2

Touch lower left area of screen (where checkmark is located) until digits illuminate.

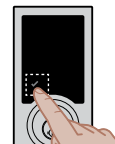

Option 3

Touch screen with three or more fingers until digits illuminate.



SecureScreen™

SecureScreen is an added-security feature that displays random digits before you enter a user code to unlock the door. This feature ensures that there are fingerprints on all digits so that codes cannot be identified by examining the touchscreen for fingerprints.



If desired, this feature can be disabled inside the Premis app.

Lights and Sound

Status LED Colors

The Status LED blinks every 6 seconds on lock interior to communicate whether the door is locked or unlocked, or if the batteries are low. The Status LED may be turned off inside the Premis app.

Note: During the pairing process, the Status LED will flash red and green, followed by a short beep (if the lock's sound is not muted).

Sound

The lock beeps during normal use and programming. If desired, you may mute the lock inside the Premis app.



Amber flash
Door is locked

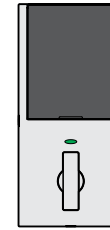

Green flash
Door is unlocked.

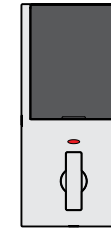

Red flash
The 4 AA batteries in the interior assembly are low and need to be replaced.

System Alerts

Note: Beeping will not be heard if the lock's sound is muted.

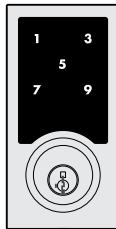

X-pattern

Flashes 1 time with 1 beep

- Incorrect user code entered.

Flashes 3 times with 3 beeps

- No user codes programmed.
- Programming timeout after 20 seconds.
- Unsuccessful programming.

Flashes 15 times with 15 beeps

- 3 incorrect codes entered within 1 minute (you may re-enter code after 60 second touchscreen lockout).



Checkmark & Lock

Flashing simultaneously 5 times with long continuous beep

- Low battery.

Alternate flashing 5 times with long continuous beep

- Door jammed while attempting to lock.



Beeping only

Lock beeps continuously

- Tamper alarm sounds when cable is disconnected. Remove the battery pack, reconnect the cable, and reinstall the battery pack.

Manual Door Handing

If needed, the door handing process can be initiated manually. This is useful if the lock is being moved to a different door.

1 Remove battery pack.



2 Press and HOLD the Program button while reinserting the battery pack.

Release button once battery pack is installed. The status LED will flash red and green.

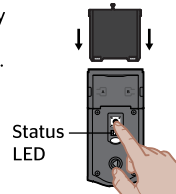

3 Press the Program button once more.

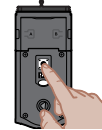

4 The latch bolt will extend and retract to learn the orientation of the door.

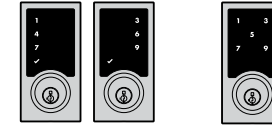

Success

Failure

If the touchscreen indicates a failure, see the online Premis User Guide at www.kwikset.com/support/guides/premis-user.

Resetting the Lock

Three methods are available to reset your Premis lock, depending on your needs:

1. Network Reset

A network reset will do the following:

- Remove the lock from your Premis app and HomeKit system.

All users and schedules will still be in place after a network reset. They will be rediscovered by the Premis app once you pair the lock again.

From the Premis App:

Follow the instructions in the Premis app to delete your lock.



From the lock:

Press and hold Button "A" on the back panel for 7 seconds, until the lock beeps one time.

2. System Reset

A system reset will do the following:

- Remove the lock from your Premis app and HomeKit system.
- Remove all users, schedules, and user codes that were added inside the app.
- Remove all user codes that were programmed directly at the lock.
- Disable Auto-Lock.
- Turn on the Status LED if it was turned off inside the Premis app.
- Re-enable SecureScreen if it was disabled inside the Premis app.
- Unmute sound if it was muted from the Premis app.

To perform a system reset, press and hold Button "A" on the back panel for 20 seconds. The lock will beep after 7 seconds. Keep holding until you hear a second beep.

3. Factory Reset

A factory reset will do the following:

- Remove the lock from your Premis app and HomeKit system.
- Remove all users, schedules, and user codes that were added inside the app.
- Remove all user codes that were programmed directly at the lock.
- Disable Auto-Lock.
- Turn on the Status LED if it was turned off inside the Premis app.
- Re-enable SecureScreen if it was disabled inside the Premis app.
- Unmute sound if it was muted from the Premis app.
- Initiate the door handing process.

Follow the instructions below to perform a factory reset:

1 Remove battery pack.

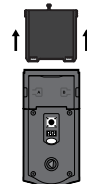

2 Press and HOLD the Program button while reinserting the battery pack.

Keep holding the button for 30 seconds until the lock beeps and the status LED flashes red.

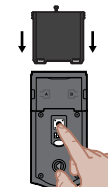

3 Press the Program button once more. The status LED will flash green and red several times.



4 After a few seconds, the lock will initiate the door handing process, and the latch bolt will extend and retract to learn the orientation of the door.

Troubleshooting

A complete troubleshooting guide is located in the online Premis User Guide at www.kwikset.com/support/guides/premis-user.

Important Safeguards

- Protect your user codes and mastercode.
- Familiarize yourself with all warning and caution statements.
- Remind all family members of safety precautions.
- Dispose of used batteries according to local laws and regulations.
- Always have access to your lock's standard key.
- Replace low batteries immediately.
- Protect the password to your Premis app.
- Protect your phone by enabling Touch ID and/or setting a passcode.
- When sending a user code, always double-check that you are sending it to the correct recipient.
- Protect and restrict access to your smartphone so that your app settings cannot be altered without your knowledge.

CAUTION: Prevent unauthorized entry. Since anyone with access to the back panel can change the user codes, you must restrict access to the back panel and routinely check the user codes to ensure they have not been altered without your knowledge. The use of a mastercode can help protect your settings.

WARNING: This Manufacturer advises that no lock can provide complete security by itself. This lock may be defeated by forcible or technical means, or evaded by entry elsewhere on the property. No lock can substitute for caution, awareness of your environment, and common sense. Builder's hardware is available in multiple performance grades to suit the application. In order to enhance security and reduce risk, you should consult a qualified locksmith or other security professional.