

Exterior Bollard LED

EB46418-UNV

INSTALLATION SHEET

START FROM HERE

- Make sure **POWER** is **COMPLETELY OFF** at the fuse box
- Have your fixture installed by a qualified licensed electrician
- Prepare everything in a clear area
- Wear gloves at all time during this installation
- Read instructions carefully before you start assembly
- Keep this installation sheet for future reference

Technical Support: 1-855-855-8926

Please Note:

- This Kuzco LED fixture comes with pre-wired LED module(s)
- Unless instructed, Do Not touch any part of the LED module(s) as any unnecessary contact with the module could cause permanent damage
- For dimming, an ELV (Electronic Low Voltage) or TRIAC type of dimmer is required
- 120~277V input

1. Remove fixture from its original package
2. Provide means to bring supply wiring to bollard in accordance with local code before pouring concrete
3. Secure anchor bolts (1c) to mounting guide plate (1e) with hex nuts and washers provided (1d) before concrete cures (See Illustration 1)
4. After concrete is set, replace mounting guide plate (1e) with mounting base (2b), adjust mounting base to desired orientation and secure with hex nuts and washers (1d)
5. Pull conduit through base plate to make proper electrical connection (black to hot "L", white to neutral "N", ground to "GND") with wire nuts (1b) provided in hardware package, tie access wires to avoid contact with ground
6. Align interior bump on fixture base (3a) with slot on mounting base (2b) (See Illustration 2), rotate to desired orientation, and secure fixture base (3a) to mounting base (2b) with screws (3b). Secure fixture head (1a) to fixture base (3a) with screws (2a)

Illustration 1

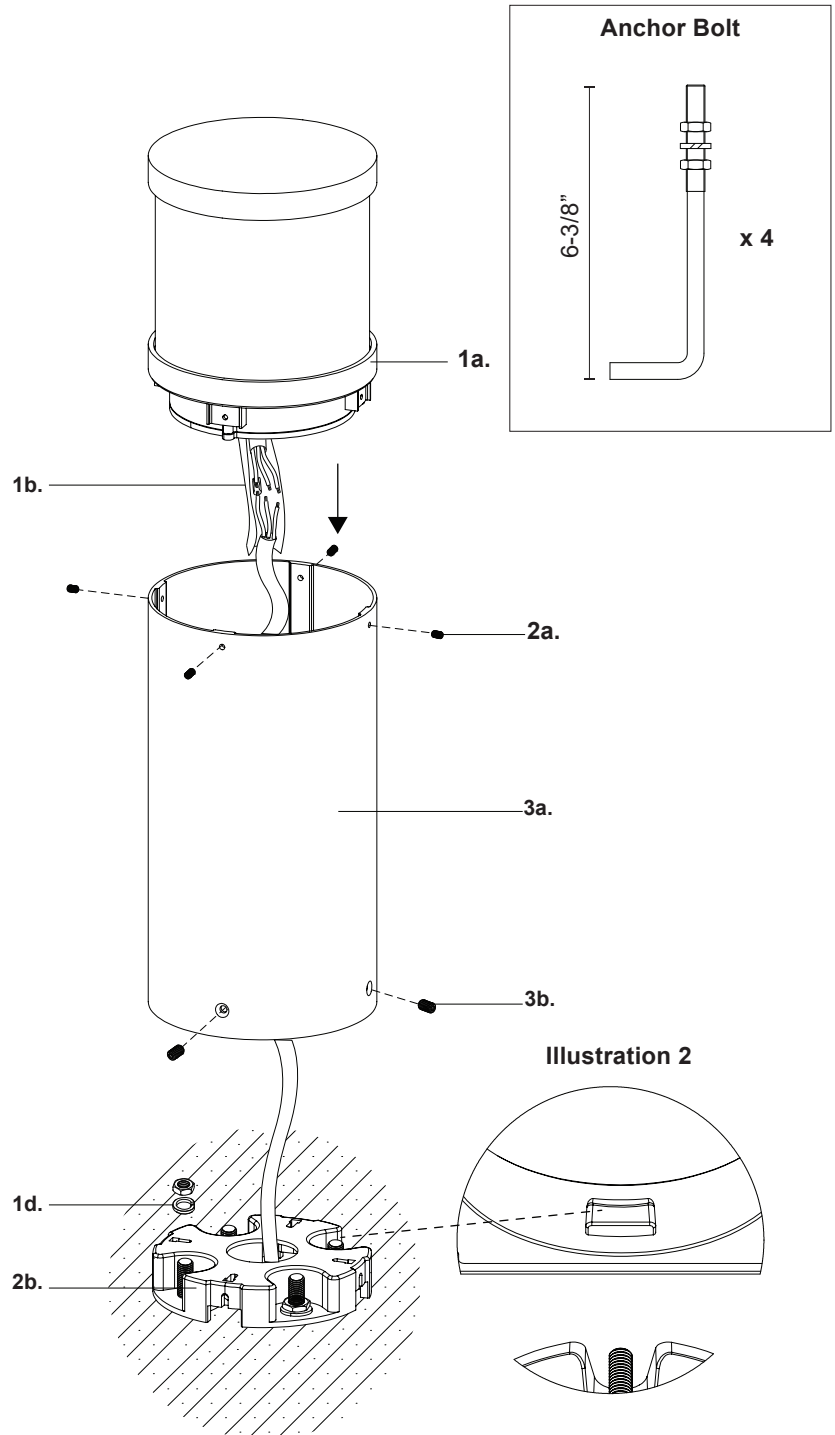
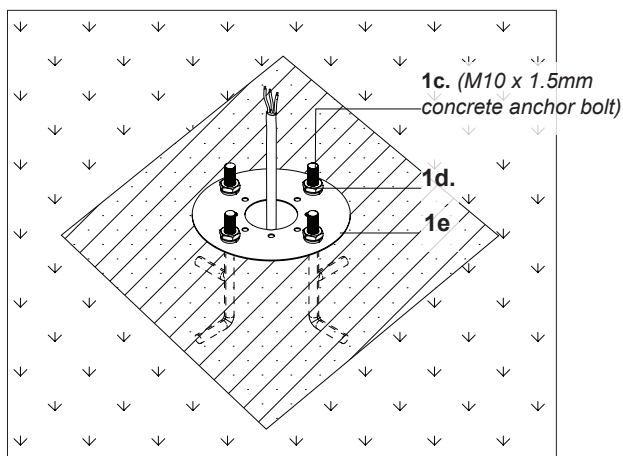

KUZCO

19054 28th Avenue Surrey, BC Canada V3Z 6M3
T: 604 538 7162 TF: 1-855 85 KUZCO F: 604 538 7196
W: kuzcolighting.com
20240318

START FROM HERE

- Make sure **POWER** is **COMPLETELY OFF** at the fuse box
- Have your fixture installed by a qualified licensed electrician
- Prepare everything in a clear area
- Wear gloves at all time during this installation
- Read instructions carefully before you start assembly
- Keep this installation sheet for future reference

Please Note:

- This Kuzco LED fixture comes with pre-wired LED module(s)
- Unless instructed, Do Not touch any part of the LED module(s) as any unnecessary contact with the module could cause permanent damage
- For dimming, an ELV (Electronic Low Voltage) or TRIAC type of dimmer is required
- 120~277V input

Technical Support: 1-855-855-8926

Mounting Guide Template

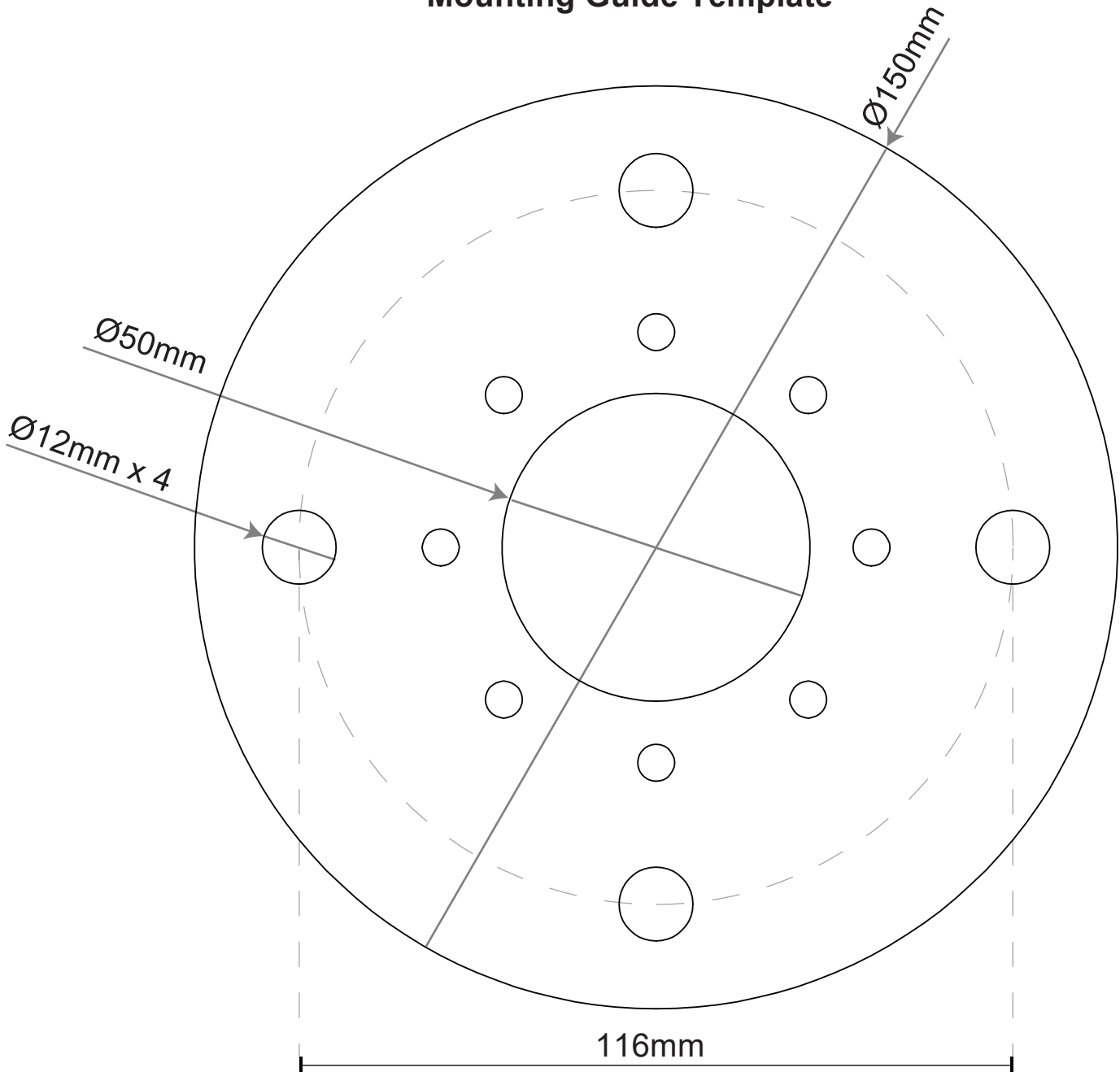

KUZCO

19054 28th Avenue Surrey, BC Canada V3Z 6M3
T: 604 538 7162 TF: 1-855 85 KUZCO F: 604 538 7196
W: kuzcolighting.com
20240318