

CH352430

Chandelier

TECHNICAL SUPPORT

1.855.855.8926

technicalsupport@aloralighting.com

⚠ WARNINGS AND CAUTIONS

- Make sure **POWER** is **COMPLETELY OFF** at the fuse box
- Have your fixture installed by a qualified licensed electrician
- Prepare everything in a clear area
- Wear gloves at all times during this installation
- Read instructions carefully before you start assembly
- Keep this installation sheet for future reference

Please Note:

- 120V input

NOTICE

- The important safeguards and instructions outlined in this sheet cannot cover all possible conditions and situations that may occur. It must be understood that caution and certain care factors must be followed. These instructions are provided for your safety and we highly recommend that a licensed, trained electrician install this unit.
- This fixture is designed to be mounted on a correctly installed standard round or octagon box OR through a wiring box with a plaster frame. The box must be securely mounted to the structure of the building. The crossbar and hardware supplied should be used, directly mounting the fixture to the outlet box may make it impossible to correctly align the fixture.

ASSEMBLY INSTRUCTIONS

Step 1

Remove fixture from its original package.

Step 2

Remove the mounting plate (1c) from within the canopy (2a) by loosening the finial (3a).

Step 3

Attach mounting plate (1c) to electrical junction box (1a) using junction box screws provided (1e) in hardware package.

Step 4

Determine hanging height of fixture by selecting from chain supplied (2d). Remove any unwanted length by opening the last link with chain pliers and install the top quick link (2c) to the beginning end of the chain, after weaving fixture wires through chain and secure top quick link (2c) to the canopy (2a).

Step 5

Make proper electrical connections (**black to hot "L"**, **white to neutral "N"**, **ground to "GND"**) with wire nuts (1b) provided in hardware package.

Step 6

Attach canopy (2a) to mounting plate (1c) with finial (3a) by threading clockwise.

Step 7

Install the recommended lamp (4a) (not provided) (referred on the socket label for maximum wattage and type) to fixture socket (4b).

You are now ready to enjoy your fixture.

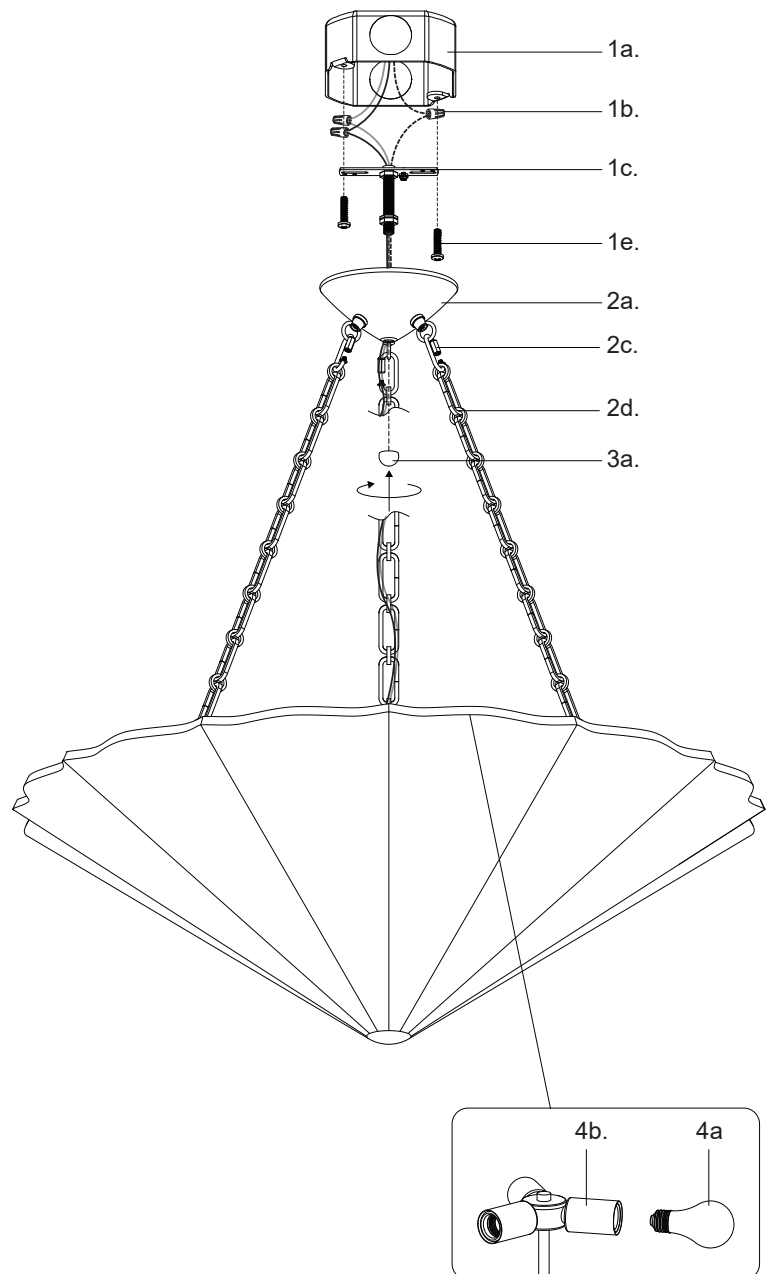

alora

P: 1.855.855.8926

CANADA: 19054 28th Avenue Surrey - BC V3Z 6M3

USA: 3035 E. Lone Mountain Rd - Las Vegas, NV, 89081

www.aloralighting.com

20230619