

LED Vanity Light

VL62236
INSTALLATION SHEET

START FROM HERE

- Make sure power is completely off at the fuse box.
- Have your fixture installed by a qualified licensed electrician
- Prepare everything in a clear area.
- Wear gloves at all times during this installation.
- Read instructions carefully before you start assembly.
- Keep this instruction sheet for future reference.

Technical Support: 1-877-452-6858

Please Note:

- All Kuzco LED fixtures come with pre-wired LED module(s).
- Unless instructed to do so, please do not touch any part of the LED module(s) as any unnecessary contact with the module could cause permanent damage.
- For dimming, an ELV (Electronic Low Voltage) type of dimmer is required.

(Octagon junction box install)

- 1.** Remove the fixture from its original packaging. Remove the crossbar (**1c**) from within the fixture (**3a**) by unthreading the set screws (**3b**) and two screws (**2c**). Attach the crossbar (**1c**) to the electrical junction box (**1a**), using screws (**1d**) provided in the hardware package.
- 2.** Make sure to thread the wires through the hole in the backplates (**2a and 2b**) and connect all wires correctly G ground to ground, N neutral wire (white to white), L live wire (black to black) with provided marettes (**1b**) from the hardware package. Attach the backplates (**2a and 2b**) to the crossbar with screws (**2c**). Connect the fixture to the backplate (**2b**) and adjust as necessary. Use the set screws and allen key (**3b**) provided to lock the fixture in place
- 3.** You have now completed the installation of your fixture, enjoy.

(Single gang box install)

- 1.** Remove the fixture from its original packaging. Remove the backplate (**1c**) from within the fixture (**2b**) by unthreading the set screws (**2a**). Connect all wires correctly G ground to ground, N neutral wire (white to white), L live wire (black to black) with provided marettes (**1b**) from the hardware package. Attach the backplate (**1c**) to the single gang box (**1a**), using screws (**1d**) provided in the hardware package.
- 2.** Attach the fixture (**2b**) to the backplate (**1c**) and adjust as necessary. Use the set screws and allen key (**2a**) provided to lock the fixture in place
- 3.** You have now completed the installation of your fixture, enjoy.

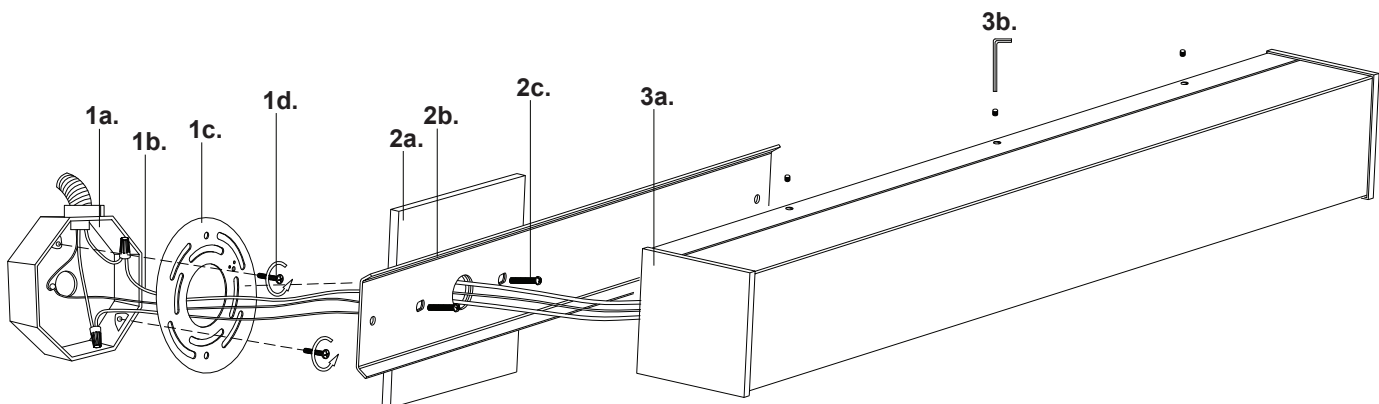
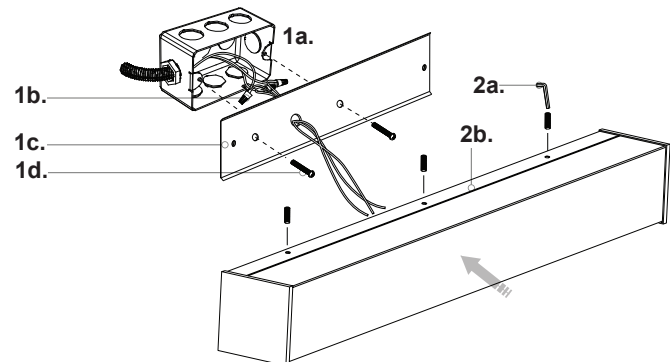

Illustration 1

KUZCO

19054 28th Avenue Surrey, BC Canada V3S 6M3
T: 604 538 7162 TF: 1-855 85 KUZCO F: 604 538 7196
W: kuzcolighting.com
20190313