

Ceiling LED Pendant

PD4418
INSTALLATION SHEET

START FROM HERE

- Make sure power is completely off at the fuse box.
- Have your fixture installed by a qualified licensed electrician
- Prepare everything in a clear area.
- Wear gloves at all times during this installation.
- Read instructions carefully before you start assembly.
- Keep this instruction sheet for future reference.

Technical Support: 1-877-452-6858

Please Note:

- All Kuzco LED fixtures come with pre-wired LED module(s).
- Unless instructed to do so, please do not touch any part of the LED module(s) as any unnecessary contact with the module could cause permanent damage.
- For dimming, an ELV (Electronic Low Voltage) type of dimmer is required.

Remove the fixture from its original packaging. Remove the canopy mounting plate from within the canopy and attach it to the electrical junction box on the ceiling using the two screws provided in the hardware package.

Select the desired length you would like the fixture to hang down from the ceiling (72" maximum). To set the fixture hanging height, undo the wire safety lock in the center of the canopy until the electrical wire can move freely. Once the wire has been released, you can push the wire up to shorten, or pull the wire down to lengthen. When you have selected your desired length, tighten the wire safety lock in the center of the canopy and the wire will be held tightly in place, (2a) then slide the wire safety grip down the wire closest to the inside of the canopy where the wire enters.

Attach the canopy to the mounting plate, which is attached to the electrical junction box on the ceiling. First attach all wiring with the provided marrets (white to white "N", black to black "L", ground to ground "G"). Align the two holes from the canopy to the two screws pointing down from the mounting plate. Push the screws through the canopy plate so they are poking through, once this is complete you can screw on the decorative nuts until tight.

Attach the inner glass piece by first removing the two screws from the sides of the lamp socket. Insert the end of the glass, which has the predrilled screw holes in it, and line them up to the holes in the side of the lamp socket. Gently screw the screws back into the sides of the lamp socket, and the glass, until the inner glass piece is secure (do not over tighten).

Locate the three pins from inside the hardware package. These pins are to hold the outer glass onto the pendant. Take the pendant lamp socket, with the inner glass installed, and gently guide the inner glass piece through the center of the outer glass piece until one of the holes in the outer glass lines up with one of the holes in the metal disc above the lamp socket. Insert a pin through the hole in the glass, and screw it in to the hole on the metal disc until it is tight (do not over tighten). Now proceed to line up the other two holes in the glass with the holes in the metal disc, insert the pins, then screw them in until they are tight (do not over tighten).

You have now completed the installation of your fixture, please enjoy.

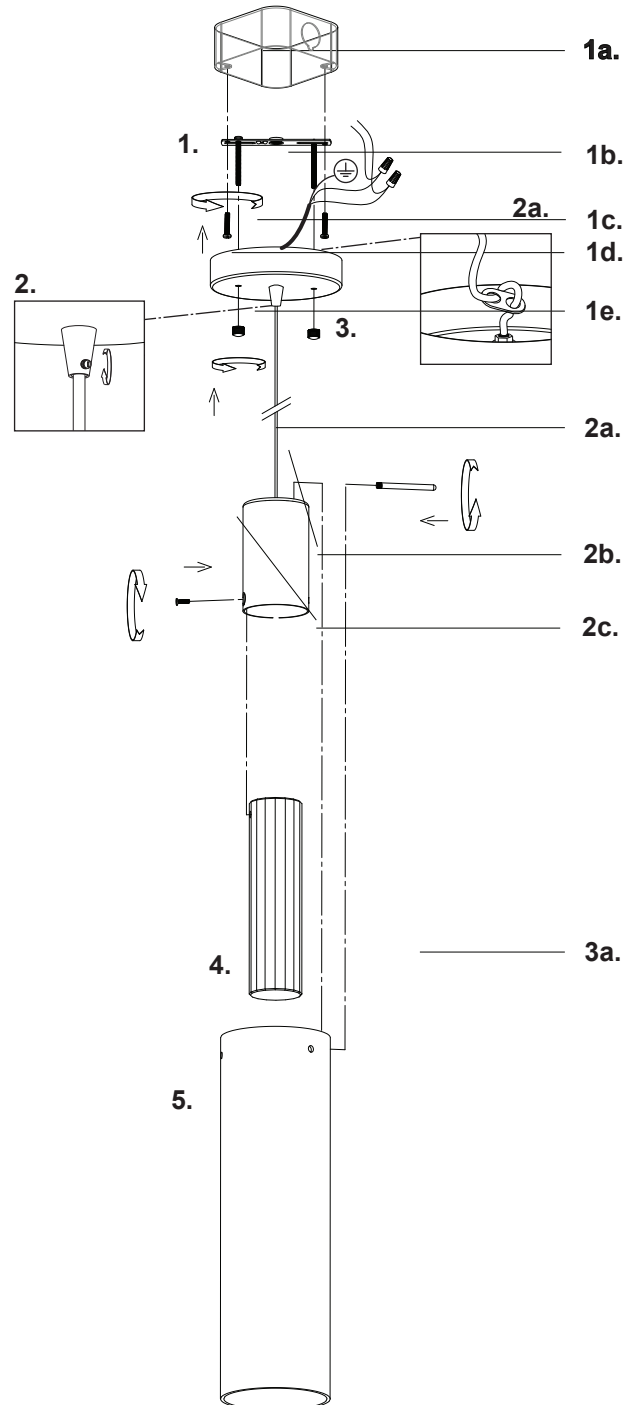

KUZCO
LIGHTING

19054 28th Avenue Surrey, BC Canada V3S 6M3
T: 604 538 7162 TF: 1-855 85 KUZCO F: 604 538 7196
W: kuzcolighting.com
20170123