

# LED Pendant

**PD19347**  
INSTALLATION SHEET

## START FROM HERE

- Make sure power is completely off at the fuse box.
- Have your fixture installed by a qualified licensed electrician
- Prepare everything in a clear area.
- Wear gloves at all times during this installation.
- Read instructions carefully before you start assembly.
- Keep this instruction sheet for future reference.

**Technical Support: 1-855-855-8926**

### Please Note:

- For dimming, a TRIAC or an ELV type of dimmer is required.

- 1.** Remove the fixture from its original packaging. Remove the canopy cover (2a) from the mounting plate (1c) by removing the screws (1e). Attach the mounting plate (1c) to the electrical junction box (1a) using the two screws (1d) provided in the hardware package. Select the desired length you would like the fixture to hang down from the ceiling (120" maximum). To set the fixture hanging height, simply push in the sleeve (2b) at the canopy where the wire comes out from. Push the wire up to shorten, or pull the wire down to lengthen. Release the sleeve (2b) and the wire will be held tightly in place.
- 2.** Connect all wiring with the provided marrettes (1b) (white to white "N", black to black "L", ground to ground "G"). Attach the canopy cover (2a) to the mounting plate (1c) and secure with screws (1e).
- 3.** You have now completed the installation of your fixture, enjoy.

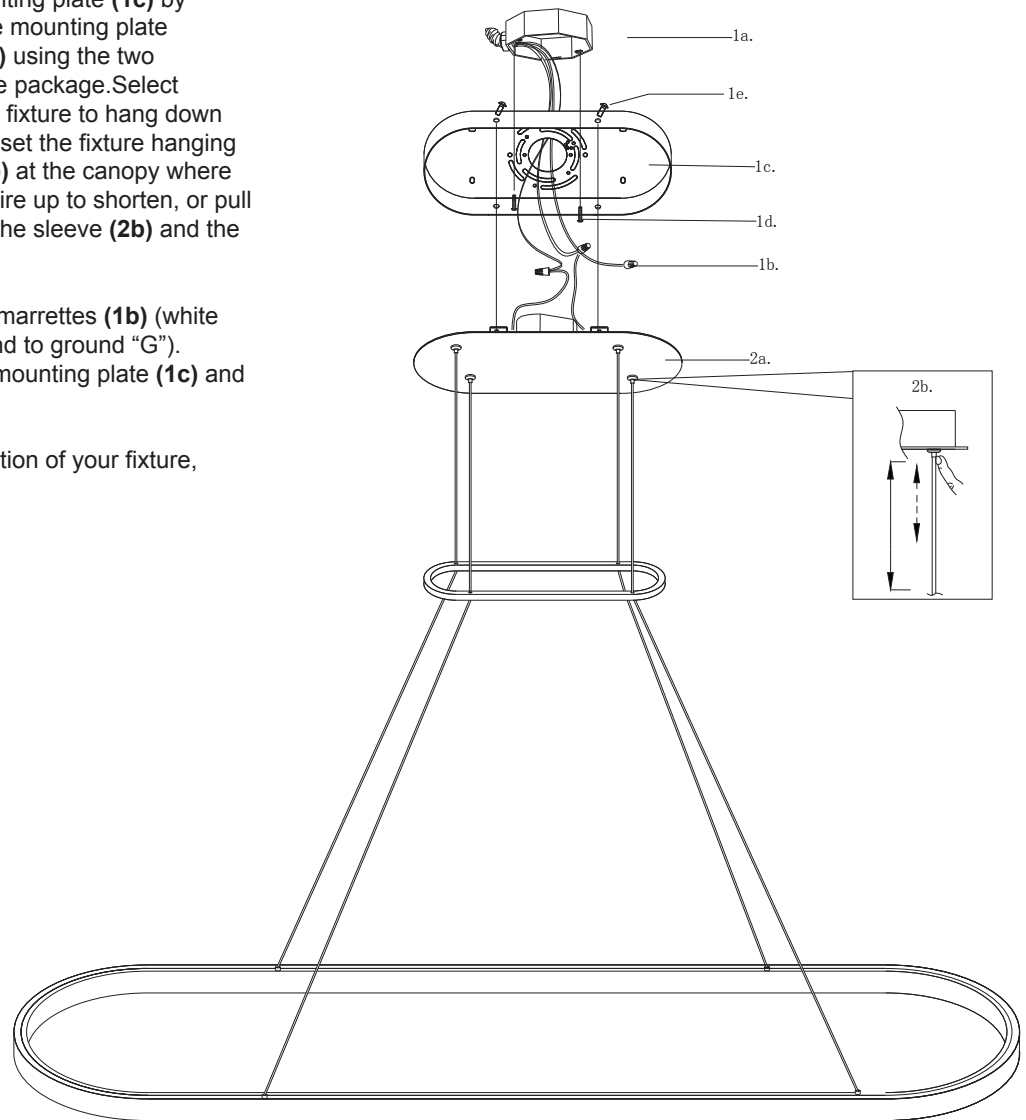

**KUZCO**

19054 28th Avenue Surrey, BC Canada V3S 6M3  
T: 604 538 7162 TF: 1-855 85 KUZCO F: 604 538 7196  
W: kuzcolighting.com  
20190104