

LED Lamp Flush Mount Ceiling Fixture

FM2011

INSTALLATION SHEET

Please Note:

- All Kuzco LED fixtures come with pre-wired LED module(s).
- Unless instructed to do so, please do not touch any part of the LED module(s) as any unnecessary contact with the module could cause permanent damage.
- For dimming, an ELV (Electronic Low Voltage) dimmer is required.

START FROM HERE

- Make sure power is completely off at the fuse box.
- Have your fixture installed by a qualified licensed electrician
- Prepare everything in clear area.
- Wear gloves at all times during this installation.
- Read instructions carefully before you start assembly.
- Keep this instruction sheet for future reference.

Technical Support: 1-877-452-6858

- 1.** Remove the fixture from its original packaging and remove the fixture mounting plate from within the hardware package. Attach the fixture mounting plate to the electrical junction box on the ceiling using the two screws provided in the hardware package.
- 2.** Attach the fixture to the mounting plate, which is attached to the electrical junction box on the ceiling. First attach all wiring with the provided marrets (*white to white "N", black to black "L", ground to ground "G"*). Push the screws through the holes in the back of the fixture so they are poking through into the center of the fixture. Once this is complete you can tighten the screws (in a clockwise direction) until the fixture is secured to the ceiling.
- 3.** Install the glass cover to the fixture. The glass cover is installed by sliding the glass into the fixture and then turning the glass cover clockwise until it is firmly secured to the fixture (*do not over tighten*).
- 4.** You have now completed the installation of your fixture, please enjoy.

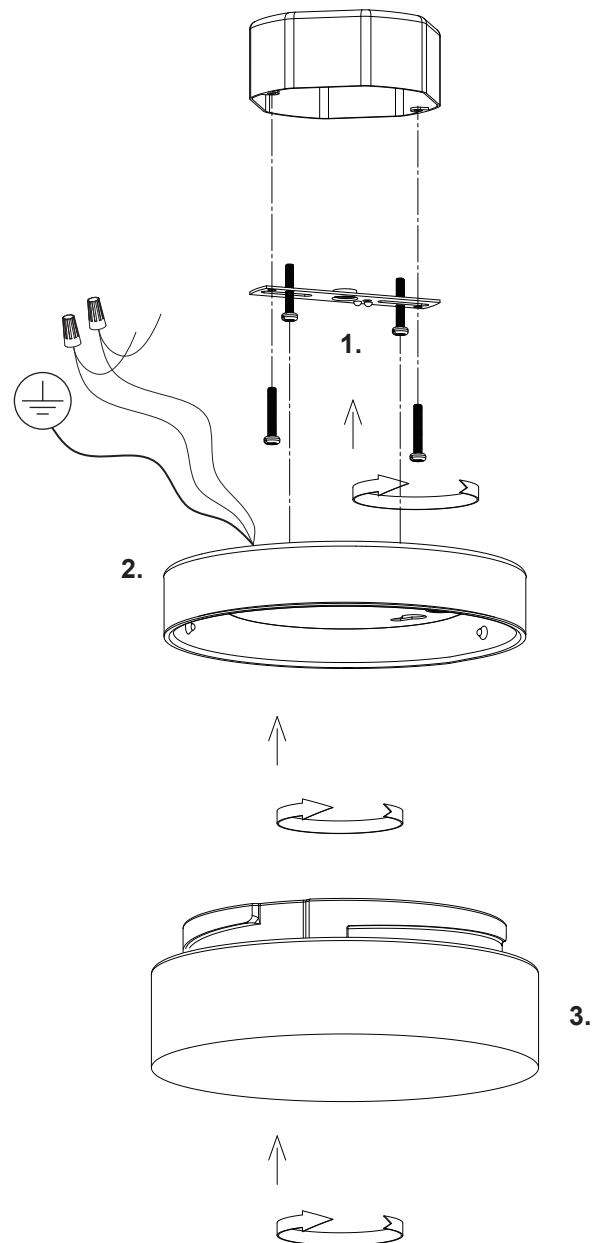

KUZCO LIGHTING

19054 28th Avenue Surrey, BC Canada V3Z 6M3
T: 604 538 7162 TF: 1-855 85 KUZCO F: 604 538 7196
W: kuzcolighting.com
20141106