

# Round LED Flush Mount

# FM11015-WH

INSTALLATION SHEET

## START FROM HERE

- Make sure power is completely off at the fuse box.
- Have your fixture installed by a qualified licensed electrician
- Prepare everything in a clear area.
- Wear gloves at all times during this installation.
- Read instructions carefully before you start assembly.
- Keep this instruction sheet for future reference.

**Technical Support:** 1-855-855-8926

## Please Note:

- All Kuzco LED fixtures come with pre-wired LED module(s).
- Unless instructed to do so, please do not touch any part of the LED module(s) as any unnecessary contact with the module could cause permanent damage.
- For dimming, an ELV (Electronic Low Voltage) type of dimmer is required.

**CAUTION:** HEAVY FIXTURE, THE JUNCTION BOX NEEDS TO BE REINFORCED BEFORE INSTALLATION.

- 1.** Remove the fixture from its original packaging. Next, remove the canopy mounting plate (1c) from the canopy (2a) by un-threading the two nuts (2b).
- 2.** Connect all wires (1b) correctly black to black "L", white to white "N" and the ground wire with provided marrets from the hardware package. Secure the mounting plate (1c) to the junction box with screws (1e). Align the mounting plate threaded rods (1d) with the holes on the surface of the canopy (2a). Next, place the canopy (2a) to the mounting plate (1c) screw in the nuts (2c) on to the mounting plate threaded rods (1d), this will secure the canopy to the mounting plate.
- 3.** Lastly, connect the glass diffuser (3a) to the canopy (2a) by turning clockwise.
- 4.** You have now completed the installation of your fixture, enjoy.

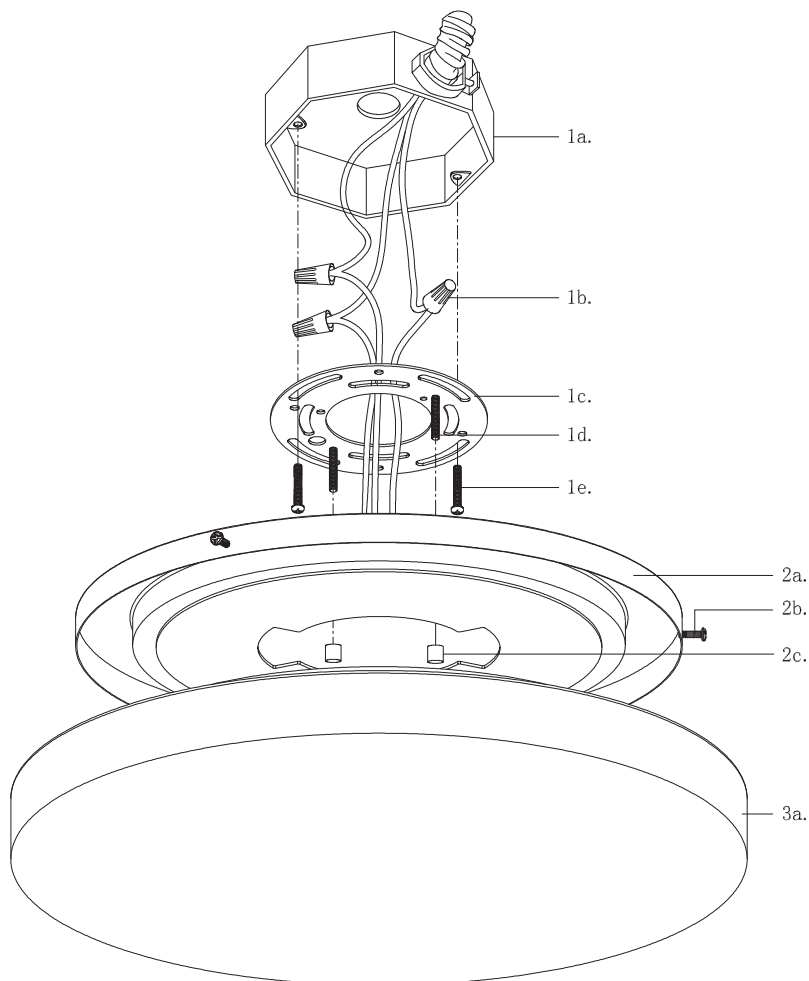

# KUZCO

19054 28th Avenue Surrey, BC Canada V3S 6M3  
T: 604 538 7162 TF: 1-855 85 KUZCO F: 604 538 7196  
W: kuzcolighting.com  
20181227