

LED Exterior Wall Sconce

EW7918
INSTALLATION SHEET

START FROM HERE

- Make sure power is completely off at the fuse box.
- Have your fixture installed by a qualified licensed electrician
- Prepare everything in a clear area.
- Wear gloves at all times during this installation.
- Read instructions carefully before you start assembly.
- Keep this instruction sheet for future reference.

Technical Support: 1-877-452-6858

Please Note:

- All Kuzco LED fixtures come with pre-wired LED module(s).
- Unless instructed to do so, please do not touch any part of the LED module(s) as any unnecessary contact with the module could cause permanent damage.
- For dimming, an ELV (Electronic Low Voltage) type of dimmer is required.

- 1.** Remove the fixture from its original packaging. Remove the mounting plate (1c) from within the canopy backplate (2b) by loosening the two set screws (2a). Attach the mounting plate (1c) to the electrical junction box (1a), using the two screws (1d) provided in the hardware package.
- 2.** Attach the canopy (2b) to the mounting plate (1c), which is attached to the electrical junction box (1a) on the wall. First attach all wiring with the provided marettes (1b) (white to white "N", black to black "L", ground to ground "G"). Now push the canopy (2b) onto the mounting plate (1c) and secure with the two set screws (2a) using the allen key provided.
- 3.** To prevent moisture from entering the outlet box and causing a short, seal around the top and side perimeter between the fixture and the wall surface with weather resistant caulking (see illustration 1). The space at bottom should be left un-caulked to prevent moisture build-up.
- 3.** You have now completed the installation of your fixture, enjoy.

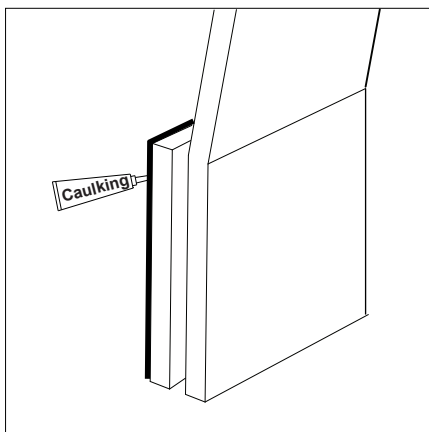
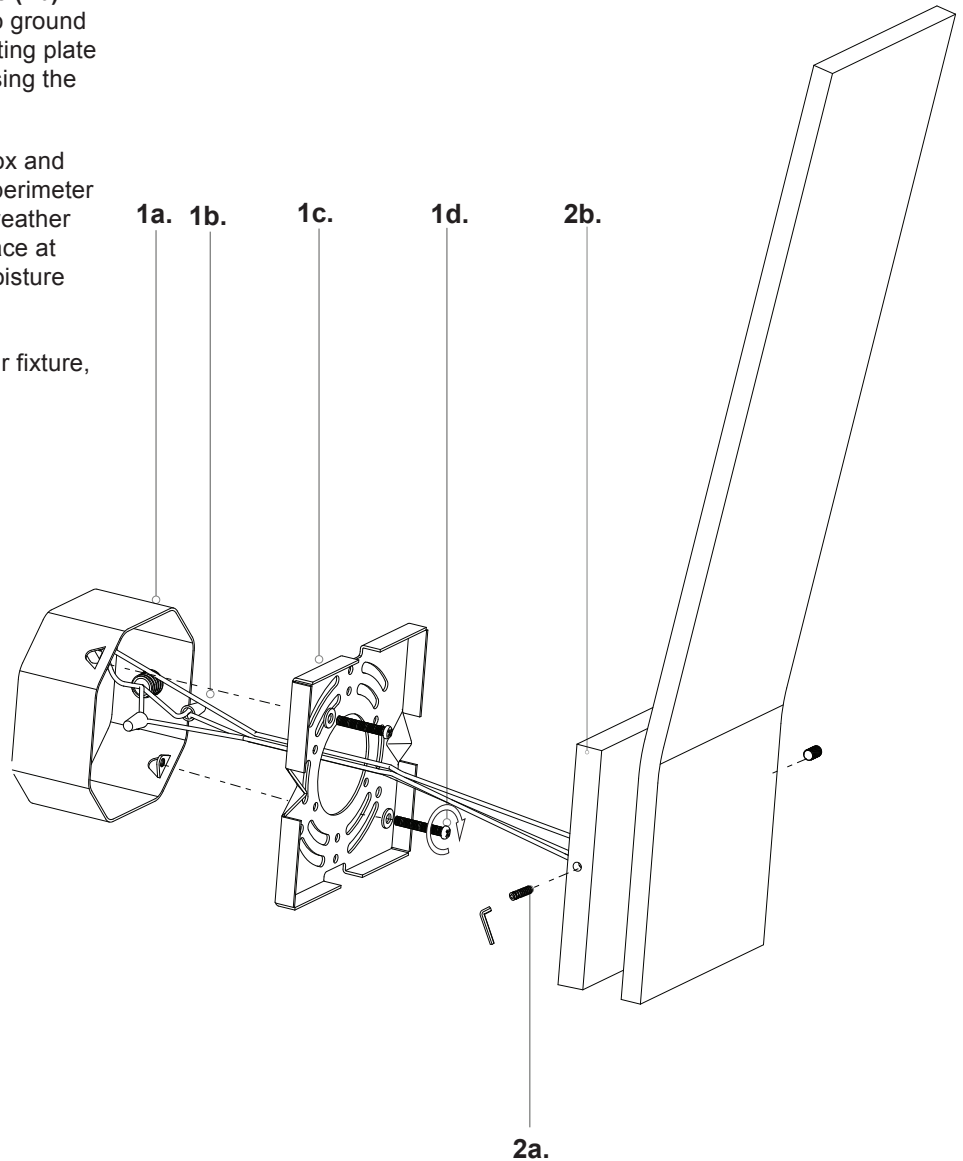

Illustration 1.



KUZCO
LIGHTING

19054 28th Avenue Surrey, BC Canada V3S 6M3
T: 604 538 7162 TF: 1-855 85 KUZCO F: 604 538 7196
W: kuzcolighting.com
20170317