

LED Exterior Wall Sconce

EW35205
INSTALLATION SHEET

START FROM HERE

- Make sure **POWER** is **COMPLETELY OFF** at the fuse box
- Have your fixture installed by a qualified licensed electrician
- Prepare everything in a clear area
- Wear gloves at all times during this installation
- Read instructions carefully before you start assembly
- Keep this installation sheet for future reference

Please Note:

- This Kuzco LED fixture comes with pre-wired LED module(s)
- Unless instructed, Do Not touch any part of the LED module(s) as any unnecessary contact with the module could cause permanent damage

Technical Support: 1-855-855-8926

1. Remove fixture from its original package.
2. Separate fixture body (2a) from mounting plate (1c) by removing set screws with allen key (2f).
3. Attach mounting plate (1c) to electrical junction box (1a) using junction box screws provided (1e) in hardware package.
4. Make proper electrical connections (black to hot "L", white to neutral "N", ground to "GND") with wire nuts (1b) provided in hardware package.
5. Attach fixture body (2a) to mounting plate (1c) with set screws and allen key (2f).

6. To prevent moisture from entering the electrical junction box (1a) and causing a short, seal around the top and side perimeter between the fixture and the wall surface with weather resistant caulking (Illustration 1). The space at the bottom should be left un-caulked to prevent moisture build up.

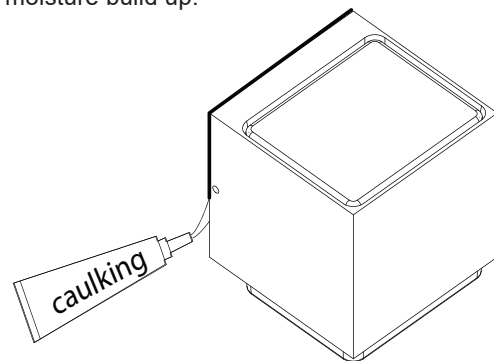
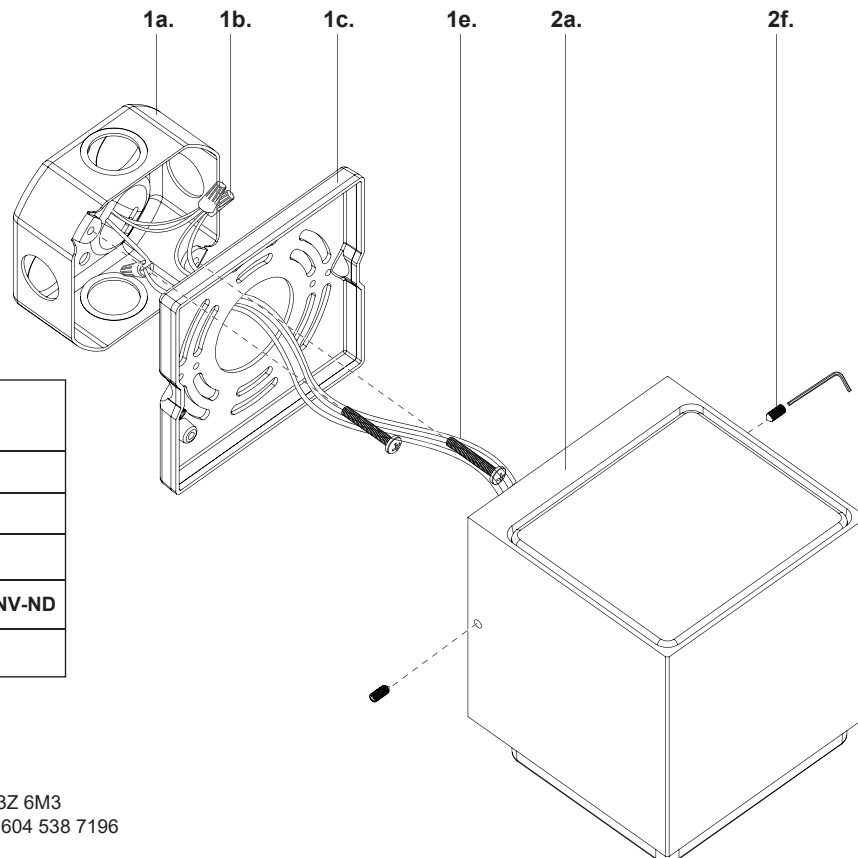

Illustration 1



PRODUCT ID	PART
1c.	XHBSC412-BK
1e.	XHPP832-8
2f.	XHSSM5-14
LED Driver	XDR-HEP-LSC9-700-UNV-ND
Allen Key	XHAK-M5

KUZCO

19054 28th Avenue Surrey, BC Canada V3Z 6M3
T: 604 538 7162 TF: 1-855 85 KUZCO F: 604 538 7196
W: kuzcolighting.com
20200306