

LED Chandelier

CH99433
INSTALLATION SHEET

START FROM HERE

- Make sure **POWER** is **COMPLETELY OFF** at the fuse box
- Have your fixture installed by a qualified licensed electrician
- Prepare everything in a clear area
- Wear gloves at all times during this installation
- Read instructions carefully before you start assembly
- Keep this installation sheet for future reference

Technical Support: 1-855-855-8926

Please Note:

- This Kuzco LED fixture comes with pre-wired LED module(s)
- Unless instructed, Do Not touch any part of the LED module(s) as any unnecessary contact with the module could cause permanent damage
- For dimming, an ELV (Electronic Low Voltage) or TRIAC type of dimmer is required

- 1.** Remove fixture from its original package
- 2.** Remove mounting plate (1c) from canopy (2a) by removing canopy screws (2b)
- 3.** Attach mounting plate (1c) to electrical junction box (1a) using screws provided (1e) in hardware package
- 4.** Secure mounting plate (1c) to mounting surface with anchors (1f) and screws (1g)
- 5.** Connect ring rods (3d) to ring connector (3c) and lock it in with screws (3b) and allen key
- 6.** Determine hanging height of fixture by securing rods (2d) to swivel (2c) and pendant body (3a)
- 7.** Make proper electrical connections (black to hot "L", white to neutral "N", ground to "GND") with wire nuts (1b)
- 8.** Attach canopy (2a) to mounting plate (1c) with canopy screws (2b)

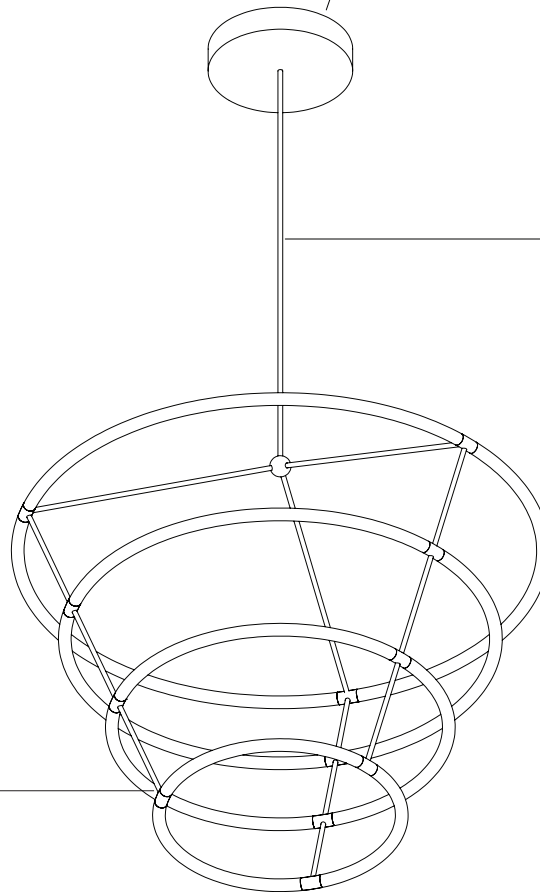
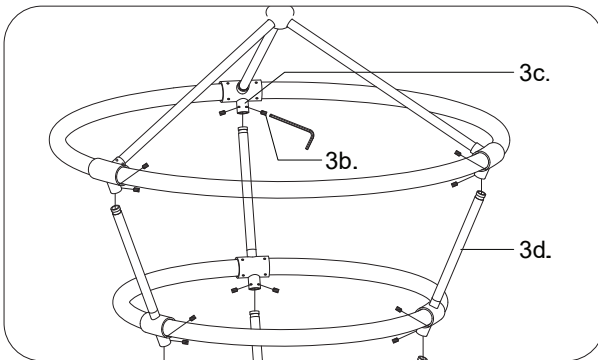
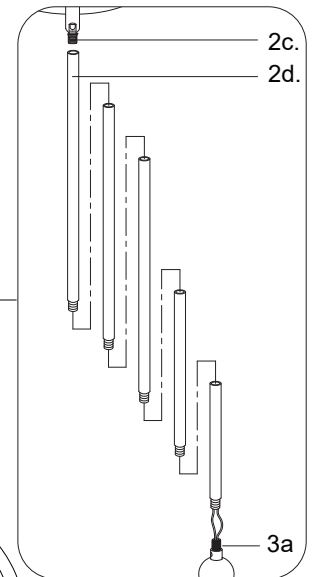
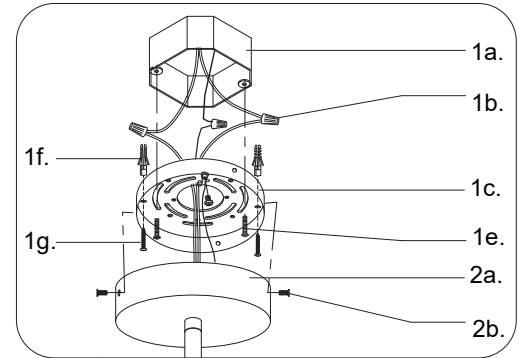

KUZCO

19054 28th Avenue Surrey, BC Canada V3Z 6M3
T: 604 538 7162 TF: 1-855 85 KUZCO F: 604 538 7196
W: kuzcolighting.com
20200629