

LED Lamp Wall Sconce

AT7928
INSTALLATION SHEET

START FROM HERE

- Make sure power is completely off at the fuse box.
- Have your fixture installed by a qualified licensed electrician
- Prepare everything in a clear area.
- Wear gloves at all times during this installation.
- Read instructions carefully before you start assembly.
- Keep this instruction sheet for future reference.

Technical Support: 1-877-452-6858

Please Note:

- All Kuzco LED fixtures come with pre-wired LED module(s).
- Unless instructed to do so, please do not touch any part of the LED module(s) as any unnecessary contact with the module could cause permanent damage.
- For dimming, an ELV (Electronic Low Voltage) type of dimmer is required.

NOTE: there are two options for connecting the base of your fixture. The first using a narrow back plate and the second using a large back plate. Use the instructions on this page to secure the large back plate to a large J box.

- 1.** Remove the fixture from its original packaging. Remove the mounting plate (1c) and anchor plate (2a) from within the canopy (2c) by loosening the two set screws (2d). Attach the mounting plate (1c) to the electrical junction box (1a), using the two screws (1d) provided in the hardware package.
- 2.** Attach the anchor plate (2a) to the mounting plate (1c), which is attached to the electrical junction box (1a) on the wall. First attach all wiring with the provided marettes (1b) (white to white "N", black to black "L", ground to ground "G"). Now connect the anchor plate (2a) to the mounting plate (1c) using the screws (2b). Now push the canopy backplate (2c) onto the anchor plate (2a). Using the set screws (2d) thread the canopy backplate to the anchor plate turning clockwise until secure.
- 3** *FOR OUTDOOR OPTION ONLY*
To prevent moisture from entering the outlet box and causing a short, seal around the top and side perimeter between the fixture and the wall surface with weather resistant caulking (see Outdoor Option). The space at bottom should be left un-caulked to prevent moisture build-up.
- 4.** You have now completed the installation of your fixture, please enjoy.

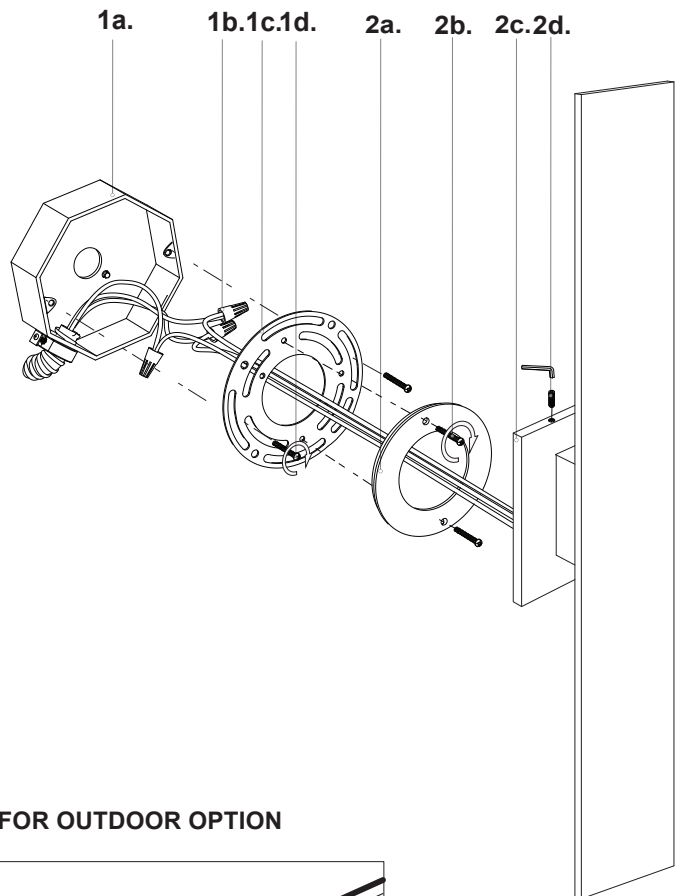

FOR OUTDOOR OPTION

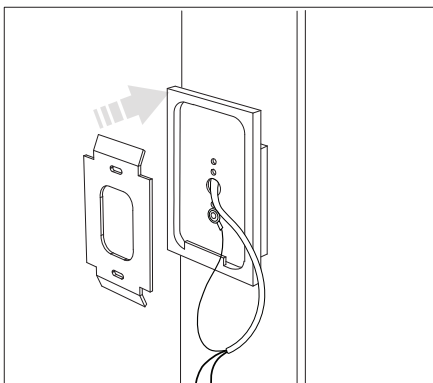

Single gang box for AT79 option
(SOLD SEPARATELY)

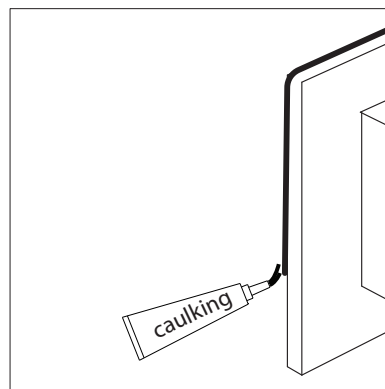

KUZCO

19054 28th Avenue Surrey, BC Canada V3Z 6M3
T: 604 538 7162 TF: 1-855 85 KUZCO F: 604 538 7196
W: kuzcolighting.com
20190926

LED Lamp Wall Sconce

AT7928
INSTALLATION SHEET

START FROM HERE

- Make sure **POWER** is **COMPLETELY OFF** at the fuse box
- Have your fixture installed by a qualified licensed electrician
- Prepare everything in a clear area
- Wear gloves at all time during this installation
- Read instructions carefully before you start assembly
- Keep this installation sheet for future reference

Please Note:

- All Kuzco LED fixtures come with pre-wired LED module(s).
- Unless instructed to do so, please do not touch any part of the LED module(s) as any unnecessary contact with the module could cause permanent damage.
- For dimming, an ELV (Electronic Low Voltage) type of dimmer is required.

Technical Support: 1-855-855-8926

NOTE: there are two options for connecting the base of your fixture. The first using a narrow back plate and the second using a wide back plate. Use the instructions on this page to secure a narrow back plate to a switch box. See instructions on back side for a large box.

- 1.** Remove the fixture from its original packaging. Remove the mounting plate (1c) from within the canopy (2a) by loosening the two set screws (2b). Attach the mounting plate (1c) to the single gang box (1a), using the two screws (1d) provided in the hardware package.
- 2.** Remove the large canopy (3c) from the back side of the fixture by removing all 4 screws (3b) (Illustration_02). Next pull off this canopy (3c). Do not lose this canopy as it contains the ETL number. Connect the small canopy (4a) to the back side of the fixture (3f) using all four screws (3b) see illustration_03. Important, secure the ground lead wire (3d) to one of the screws.
- 3.** Attach the canopy (2a) to the mounting plate (1c) on the wall. First attach all wiring with the provided marettes (1b) (white to white "N", black to black "L", ground to ground "G"). Now attach the canopy (2a) to the mounting plate (1c) (see illustration_01) by tightening the two set screws (2b) using the allen key provided in the hardware package.
- 4. *FOR OUTDOOR OPTION ONLY***
To prevent moisture from entering the outlet box and causing a short, seal around the top and side perimeter between the fixture and the wall surface with weather resistant caulking (see Outdoor Option). The space at bottom should be left un-caulked to prevent moisture build-up.
- 5.** You have now completed the installation of your fixture, please enjoy.

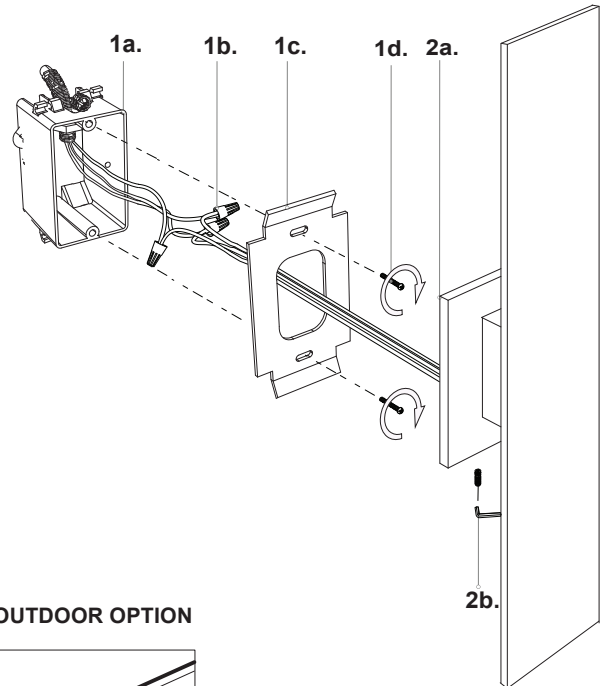

FOR OUTDOOR OPTION

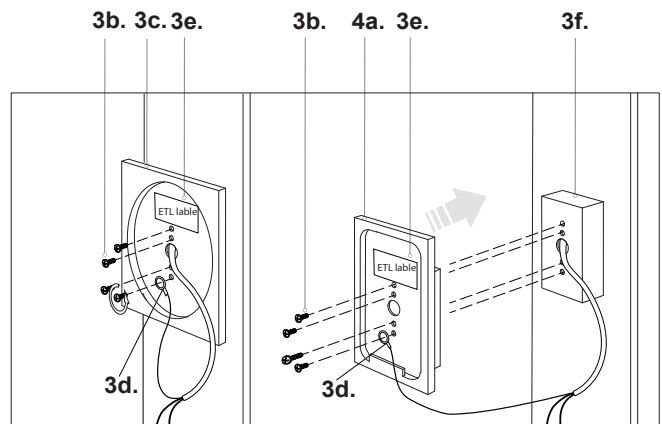
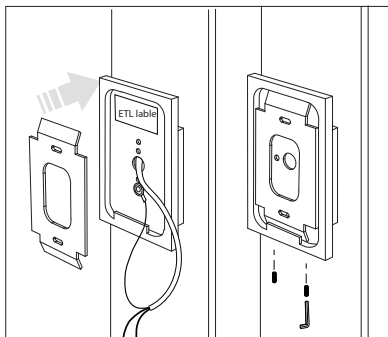
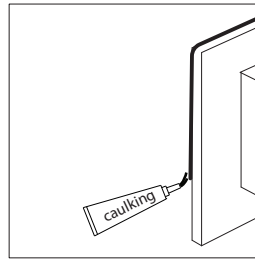

illustration_02

illustration_03

KUZCO

19054 28th Avenue Surrey, BC Canada V3Z 6M3
T: 604 538 7162 TF: 1-855 85 KUZCO F: 604 538 7196
W: kuzcolighting.com
20190926