

INSTALLATION INSTRUCTIONS

Item # P7872-420-L (New. 04/15/2020)

READ AND SAVE THESE INSTRUCTIONS

WARNING! SHUT POWER OFF AT FUSE OR CIRCUIT BREAKER.

AVERTISSEMENT! COUPER LE COURANT AU NIVEAU DES FUSIBLES OU DU DISJONCTEUR.

PREPARATION (Fig. 1)

1. Shut off power at the fuse box or circuit breaker box and remove the old fixture including the mounting hardware.
2. Carefully unpack your new fixture and lay out all the parts in a clean area. Take care not to misplace any small parts necessary for installation.

ASSEMBLING THE FIXTURE WITH CHAIN LOOP (Fig. 2)

3. Screw longest rod (O) onto the all thread (I) on top of fixture.
4. Determine the desired hanging height and thread rods (F1, F2 and F3) to the longest rod (O). Screw loop (H1) to rod (F1). Note: Pass the wires carefully through each rod as you assemble.
5. Attach the quick link (G) to loop (H1) and loop (H2) on the canopy (D). Carefully feed the wires through loop (H1), quick link (G), and loop (H2).
6. Attach the mounting plate (B) to the junction box using the junction box screws (C) (SIZE: #8-32N, L0.5"). The side of the mounting plate marked "GND" must face out.
7. The support cable is provided to support the weight of the fixture while wiring. Raise the fixture to the mounting plate (B) and attach hook (M), on the end of support cable (E), into a slot located on mounting plate (B). Carefully allow the support cable (E) to support the weight of the fixture while wiring (Fig.1).

CONNECTING THE WIRES (Fig. 3)

8. Connect the electrical wires as shown in fig.3, making sure that all wire connectors are secured. If your junction box has a ground wire (green or bare copper), connect the fixture's ground wire to it. Otherwise, connect the fixture's ground wire directly to the mounting plate (B) using the green screw provided. After wires are connected, tuck them carefully inside the junction box.

COMPLETING THE INSTALLATION (Fig. 1)

9. Raise the canopy (D) onto mounting plate (B) and secure with screws (A).
10. Install (12) twelve G9 base bulbs (K) up to 40 watts each or CFL or LED equivalent (not included) in accordance with the fixture specification—DO NOT EXCEED THE MAXIMUM WATTAGE RATING! (NE PAS DEPASSER LA PUISSANCE NOMINALE MAXIMALE!).
11. Place the glass shade (J) over the socket (L) and turn to secure it to the fixture.

Your installation is now complete. Return power to the junction box and test the fixture.

Note: Illustration (Fig. 1) on this manual is for installation purposes only. It may or may not be identical to the fixture purchased.

Fig. 1

Set# A-021-150D
-Mounting plate
-Ground screw
-Mounting screw*2

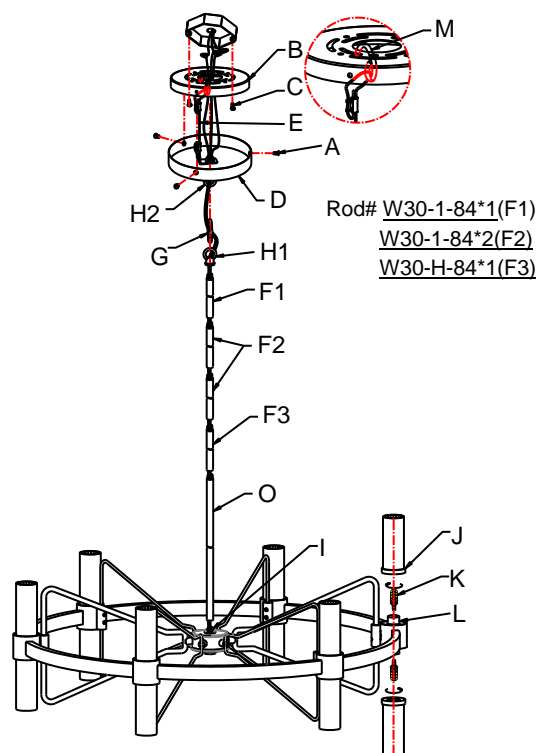

Fig. 3

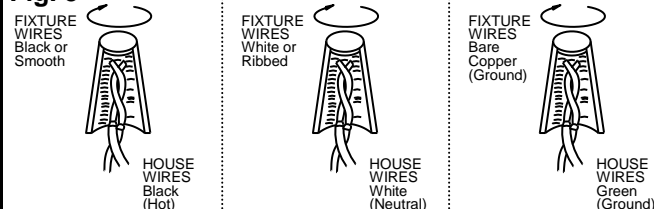
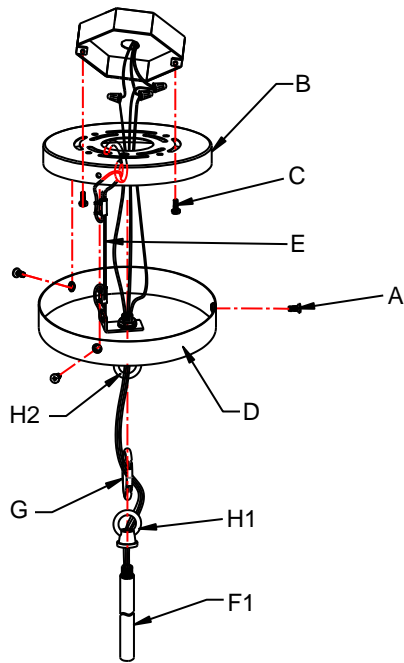
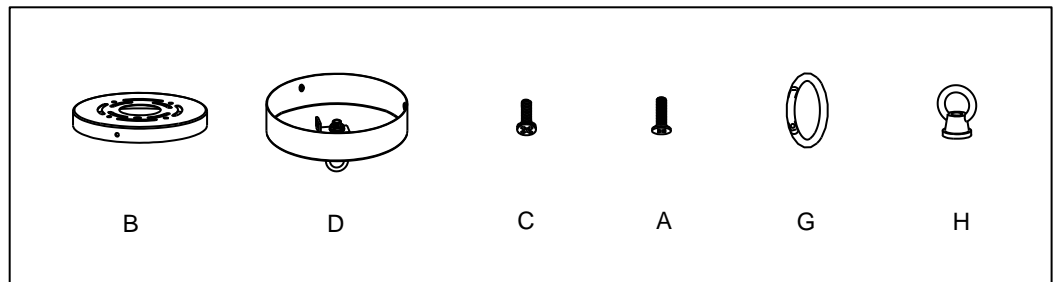

Fig.2



a. Hardware Bag:

- A. Screw*2
- B. Mounting plate*1
- D. Canopy *1
- C. Mounting Screw*2
- H. Loop*1
- G. Quick Link*1



b. Hardware Bag:

- F1. ROD 12"*1
- F2. ROD 12"*2
- F3. ROD 6"*1

