

INSTALLATION INSTRUCTIONS FOR P5292-077-L

For LED Wall Mount

READ AND SAVE THESE INSTRUCTIONS

WARNING! SHUT POWER OFF AT FUSE OR CIRCUIT BREAKER
AVERTISSEMENT! COUPER LE COURANT AU NIVEAU DES FUSIBLES OU DO DISJONCTEU

ASSEMBLING THE FIXTURE (Fig.1)

1. Shut off power at the fuse box or circuit breaker box and remove the old fixture including the mounting hardware.
2. Carefully unpack your new fixture and lay out all the parts in a clean area. Take care not to misplace any small parts necessary for installation.
3. Unscrew screws (G) to remove mounting plate (A) from the canopy (F).
4. Position mounting plate (A) on the wall and attach to the junction box using the mounting screws (B, size 8#-32N 1/2"). The side of the mounting plate marked "GND" must face out as shown in Fig.1.

CONNECTING THE WIRES (Fig. 2)

5. Pass the black/white and bare copper wires through the opening of the mounting plate (A). Connect the electrical wire as shown in figure 2, making sure that all wire connectors are secured. If your junction box has a ground wire (green or bare copper), connect the ground wire from the fixture to it. Otherwise connect fixture ground wire directly to the mounting plate (A) using the green screw (D) provided. Tuck the wire connections neatly into the ceiling junction box as you hold the canopy towards the wall.

FINISHING THE INSTALLATION (Fig.1)

6. Slide the canopy (F) over the mounting plate (A) secure with screws (G).

CAUTION/ATTENTION: When handling the fixture, do not apply pressure to the LEDs. Hold the fixture by the frame only.

Replacing LED module (Fig. 3)

The LED module can be replaced by a qualified electrician without cutting of wire and without damage to any decorative element to which the fixture is attached. See installation steps for more details (Fig 3.)

1. There is 1 LED module in each square of the fixture. If one of them do not work, replace it as shown in Fig. 3. Make sure the power is off before you replace.
2. Unscrew screws (G) and the ground screw (D) with screwdriver and disconnect the ground wire and loosen the wire connectors (N) to remove the fixture from the wall.
3. Loosen wire connectors (E), disconnect the wires respectively, and then unscrew screws (H) and screws (L) to remove lamp shade (M) and cover (K), replace a new module (J).
4. Reverse steps 3-1 to install new module.

Your installation is now complete. Return power to the junction box and test the fixture.

Note: Illustration (Fig.1) on this manual is for installation purposes only. It may or may not be identical to the fixture purchased.

Dimmable with LED compatible wall dimmer switches.

IMPORTANT: Fixtures should be installed by a qualified electrician to ensure proper wiring and installation.

Fig 1

Set# A-020-170105

- mounting plate
- Ground Screw
- Mounting Screw*2

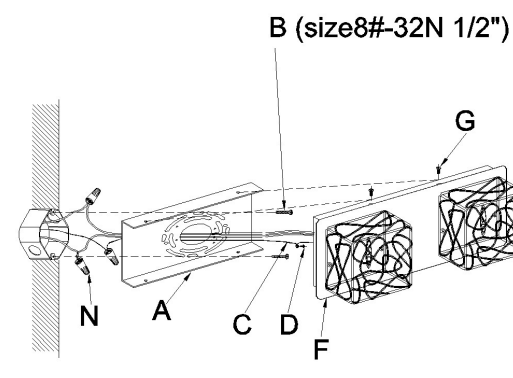

Fig.2

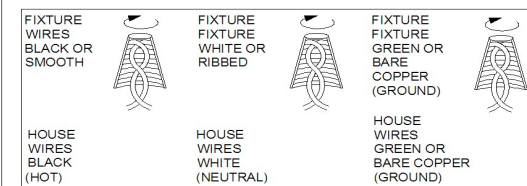

Fig 3

