

Features

- Cast iron with Safeguard® finish
- Integral flange.
- Right centered drain
- Removable drain cover.
- Complements traditional and contemporary bathroom designs
- 60" (1524 mm) x 32" (813 mm) x 4" (102 mm)

Installation

- Alcove

Required Accessories

K-9155

or

K-9156

or

K-9155 Drain Cover

or

K-9156 Drain Cover



Codes/Standards

ASME A112.19.1/CSA B45.2







ASTM F462

KOHLER® Lifetime Limited Warranty for Cast Iron Components

See website for detailed warranty information.

Available Color/Finishes

Color tiles intended for reference only.

Color	Code	Description
	0	White
	96	Biscuit
	47	Almond
	NY	Dune
	95	Ice™ Grey
	G9	Sandbar

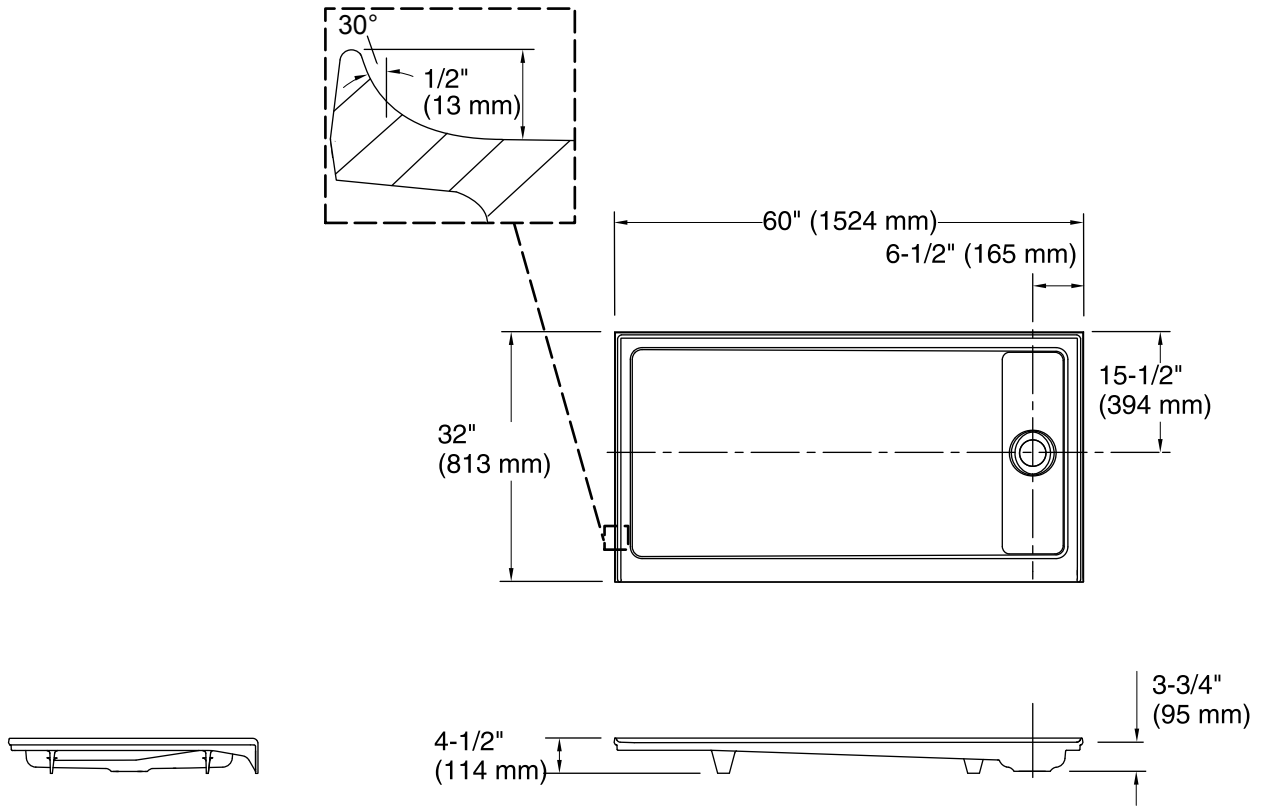

Technical Information

All product dimensions are nominal.

Installation:	3-Wall Alcove
Drain location:	Right
Drain hole diameter:	3-3/8" (86 mm)
Weight:	180 lbs (81.6 kg)
Minimum flat for door:	2-7/16" (62 mm)
Threshold height:	4" (102 mm)

Notes

Measure your actual product for rough-in details.

Install this product according to the installation instructions.

The dimensions are applicable for this product only and should not be used to fabricate substitute bases for shower enclosures.

The K-1657/K-1663 or K-1708/K-1647-PC steam generator/control kit are designed for use with this product. Kohler Co. shall not be responsible for problems encountered due to the installation and use of other manufacturer's steam generators.