



Iron Plains™ Wading Pool®

Bathroom Sink

K-5400-P5

Features

- KOHLER enameled cast iron
- Above-counter, drop-in, or under-mount installation
- With overflow

Optional Accessories

52047 Clamp Accessory Pack, 4 Ea.

Components

Product includes:

1193643 Basin Clamps



ADA

Codes/Standards

ASME A112.19.1/CSA B45.2

ADA









ICC/ANSI A117.1

KOHLER® Lifetime Limited Warranty for Cast Iron Components

See website for detailed warranty information.

Available Color/Finishes

Color tiles intended for reference only.

Color	Code	Description
	0	White
	FF	Sea Salt™
	96	Biscuit
	FD	Cane Sugar™
	NY	Dune
	G9	Sandbar
	KC	Vapour™ Blue
	KG	Vapour™ Green
	K4	Cashmere
	FT	Basalt
	20	Suede
	KA	Black 'n Tan
	7	Black Black™

USA/Canada: 1-800-4KOHLER (1-800-456-4537)

Kohler Co. reserves the right to make revisions without notice to product specifications.

For the most current Specification Sheet, go to www.kohler.com.

2-2-2017 04:05

THE BOLD LOOK
OF **KOHLER**®

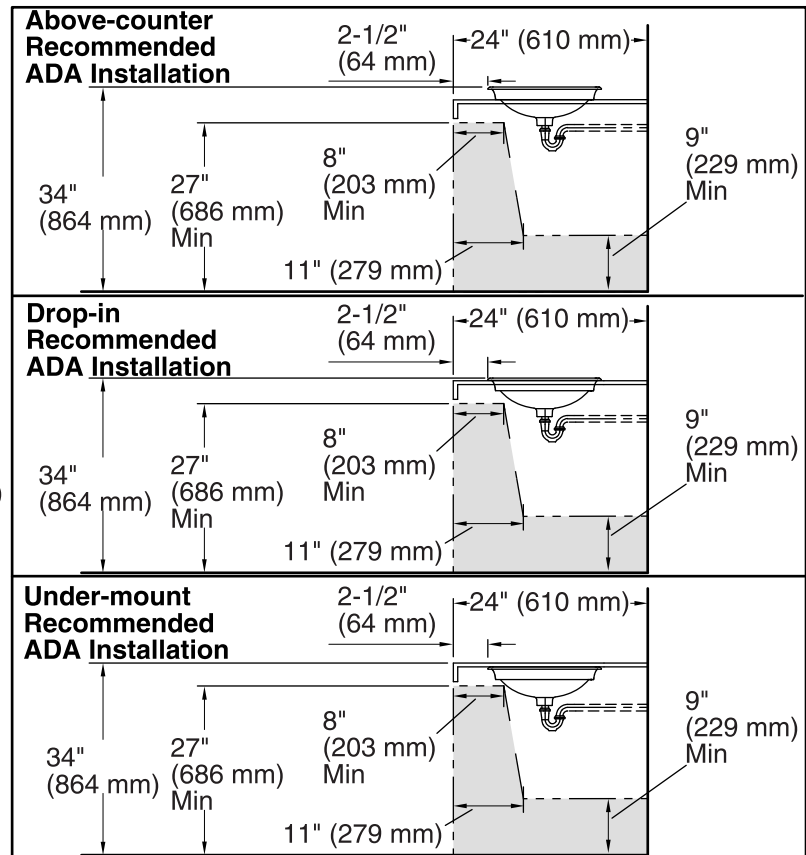
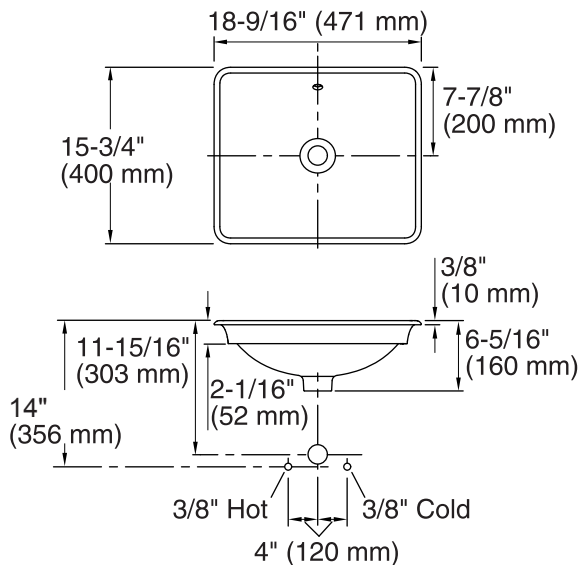

Technical Information

All product dimensions are nominal.

Bowl configuration:	Single
Installation:	Drop-In, Under-mount, Above-counter
Bowl area (Only)	Length: 17-1/2" (445 mm) Width: 14-3/4" (375 mm) Bowl depth: 4-9/16" (116 mm) With overflow: Yes Water depth: 2-15/16" (74 mm)
Bowl area	With overflow: Yes
Template:	1222632-7, required, included

Notes

Install this product according to the installation instructions.

NOTICE: Countertop manufacturer or cutter must use the cut-out template provided with the product, or a current one provided by Kohler Co. (call 1-800-4-KOHLER). Kohler Co. is not responsible for cutout errors when the incorrect cut-out template is used.

ADA compliant when installed to the specific requirements of these regulations.