



### Features

- End drain.
- Slotted overflow allows for deep soaking.
- Integral lumbar support and armrests for comfort.
- 66" (1676 mm) x 32" (813 mm) x 22" (559 mm)

### Material

- Acrylic

### Hydrotherapy

- 118-122 BubbleMassage™ airjets.
- Variable-speed pump for adjusting hydromassage intensity.
- Automatic purge cycles remove residual water from air channels after use.
- Zones of Control™ feature allows you to target airjet massage to back, midsection, or feet.
- Pump with air switch for whirlpool.
- Single-speed whirlpool offers eight fully adjustable hydro-massage jets for water flow and direction.
- Built-in 1500 W heater.
- Lighted keypad control.

### Installation

- Drop-in or under-mount.

### Required Accessories

K-7271 Brass Slotted Overflow Bath Drain

or

K-7272 PVC Slotted Overflow Bath Drain

### Recommended Accessories

K-1491 Bath/Whirlpool Pillow

K-1601 Bath/Whirlpool Footstop

K-9498 3" Keypad Trim

K-24916 Wireless Music Kit

K-550 Under-mount Installation Kit



### Codes/Standards

ASME A112.19.7/CSA B45.10

CSA B45.5/IAPMO Z124

ASTM E162

ASTM E662

UL 1795

CSA C22.2 No. 218.2

Greenguard UL 2818 - Gold











CARB P2

### KOHLER® One-Year Limited Warranty

See website for detailed warranty information.

### Available Color/Finishes

*Color tiles intended for reference only.*

Color	Code	Description
	0	White
	96	Biscuit
	47	Almond
	NY	Dune
	95	Ice™ Grey
	G9	Sandbar
	33	Mexican Sand™
	K4	Cashmere
	58	Thunder™ Grey
	7	Black Black™

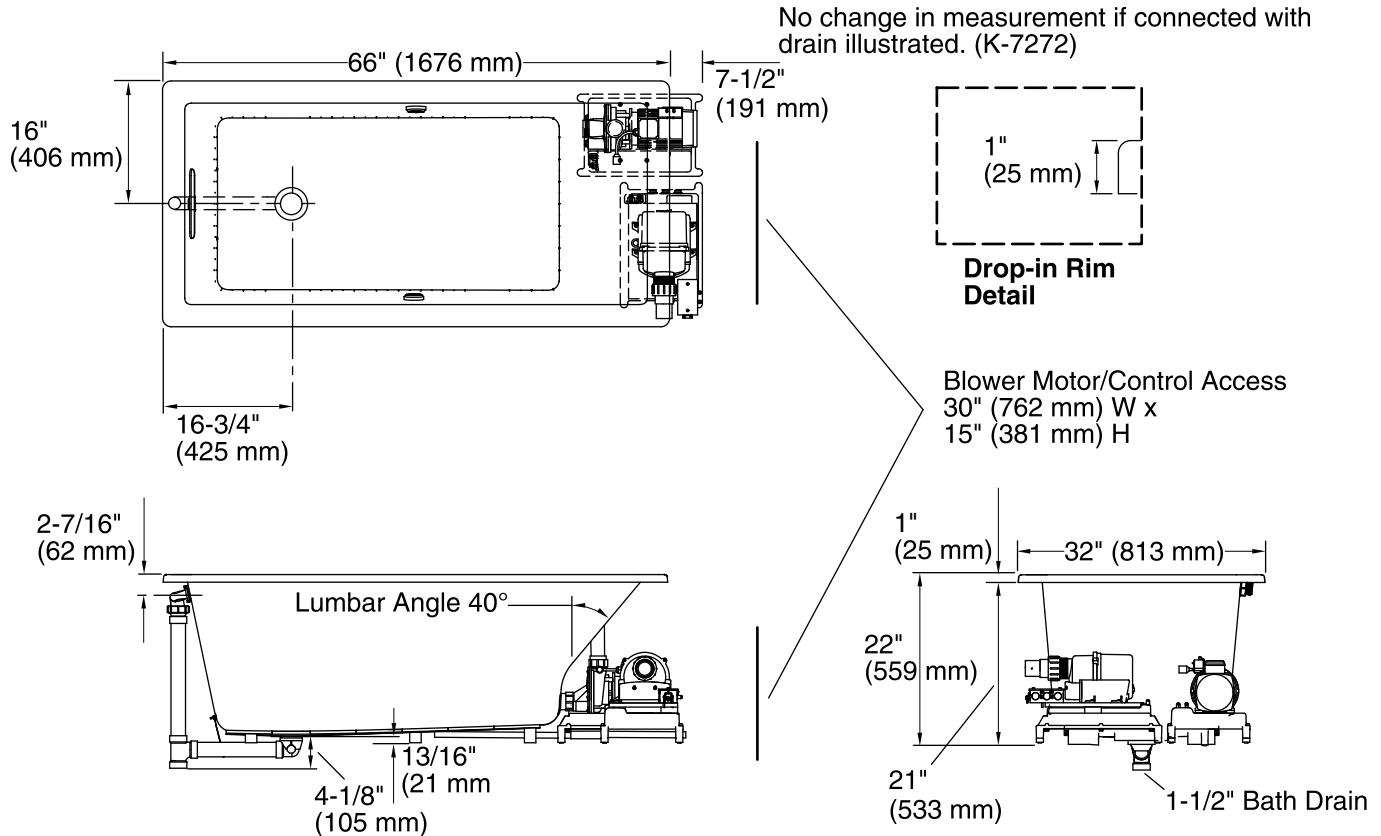

#### Required Electrical Service

One dedicated circuit required, protected with Class A Ground-Fault Circuit-Interrupter (GFCI) or Residual Current Device (RCD).

Blower, Pump: 240 V, 20 A, 50/60 Hz

#### Technical Information

All product dimensions are nominal.

Installation:	Drop-in
Drain location:	Reversible
Basin area, bottom:	44-1/2" x 22-5/16" (1130 mm x 567 mm)
Basin area, top:	59-5/8" x 25-1/2" (1514 mm x 648 mm)
Weight:	172 lbs (78 kg)
Minimum floor load:	61.5 lbs/ft <sup>2</sup> (300.3 kg/m <sup>2</sup> )
Water depth:	18" (457 mm)
Water capacity:	85.8 gal (324.8 L)
Cutout:	Drop-in, 65-1/2" x 31-1/2" (1664 mm x 800 mm)
Electrical component rating:	Blower: 240 V, 5 A, 50/60 Hz Pump: 240 V, 11 A, 50/60 Hz
Minimum flat for door:	2-1/2" (64 mm)

#### Notes

Measure your actual product for rough-in details.

Install this product according to the installation instructions.

The hot water supply should be 70% of the capacity of the bath or greater. Installations will vary.

**IMPORTANT!** Dry fit the drain assembly prior to installing the bath. The bath cannot be installed with all drain components attached.

The pump base extends 7-1/2" (191 mm) beyond the edge of the rim. Modify the framing as needed.