



Features

- End drain.
- Slotted overflow for deep soaking.
- Bask® heated surface creates spa-like relaxation with soothing warmth on your back, shoulders, and neck.
- VibrAcoustic® technology emits sound waves and offers a surround sound experience.
- Six transducers and a control amplifier with 25' (7.6 m) of wiring.
- High-resolution color screen in polished chrome.
- Integral lumbar support.
- 66" (1676 mm) x 32" (813 mm) x 22" (559 mm)

Material

- Acrylic

Installation

- Drop-in or under-mount.

Required Accessories

K-7271 Brass Slotted Overflow Bath Drain

or

K-7272 PVC Slotted Overflow Bath Drain

Recommended Accessories

1184460 Kit, UI Mounting

K-1491 Bath/Whirlpool Pillow

K-1601 Bath/Whirlpool Footstop

K-550 Under-mount Installation Kit



Codes/Standards

CSA B45.11/IAPMO Z401

ASTM E162

ASTM E662

UL 1795











Greenguard UL 2818 - Gold

KOHLER® One-Year Limited Warranty

See website for detailed warranty information.

Available Color/Finishes

Color tiles intended for reference only.

| Color | Code | Description |
|--|------|---------------|
|  | 0 | White |
|  | 96 | Biscuit |
|  | 47 | Almond |
|  | NY | Dune |
|  | 95 | Ice™ Grey |
|  | G9 | Sandbar |
|  | 33 | Mexican Sand™ |
|  | K4 | Cashmere |
|  | 58 | Thunder™ Grey |
|  | 7 | Black Black™ |

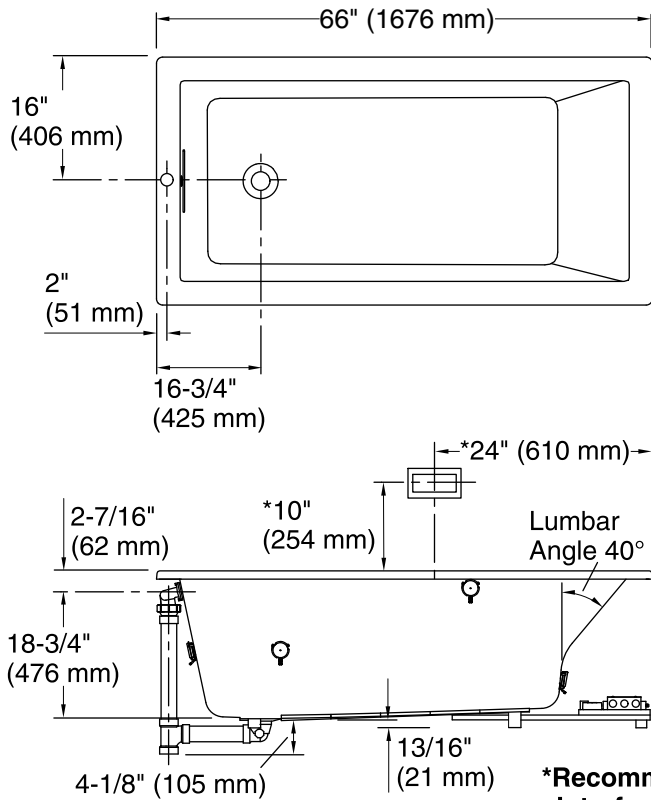

No change in measurement if connected with drain illustrated. (K-7272)

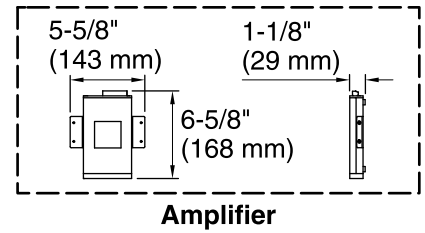
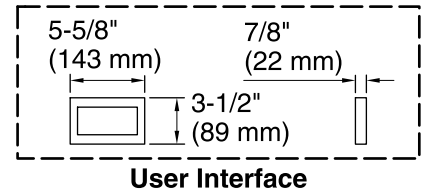
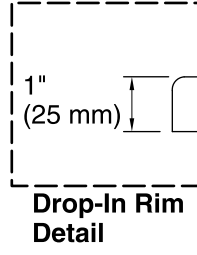

Control Access
30" (762 mm) W
x 15" (381 mm) H
Min

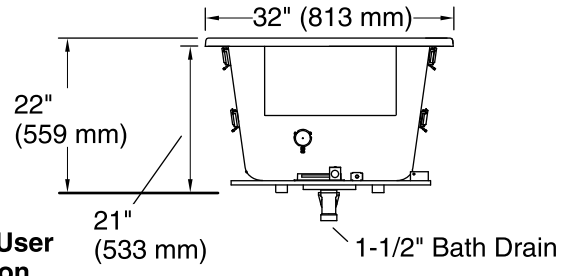

***Recommended User Interface Location**

Required Electrical Service

One circuit required, protected with Class A Ground-Fault Circuit-Interrupter (GFCI) or Residual Current Device (RCD).

Amplifier, Heated 120 V, 15 A, 50/60 Hz
Surface:

Technical Information

All product dimensions are nominal.

- Installation: Drop-in, Under-mount
- Drain location: End
- Basin area, bottom: 44-1/2" x 22-5/16" (1130 mm x 567 mm)
- Basin area, top: 59-5/8" x 25-1/2" (1514 mm x 648 mm)
- Weight: 96 lbs (43.5 kg)
- Minimum floor load: 58 lbs/ft² (283.2 kg/m²)
- Water depth: 18" (457 mm)
- Water capacity: 85 gal (321.8 L)
- Cutout: Drop-in, 64-1/2" x 30-1/2" (1638 mm x 775 mm)
- Electrical component rating: Amplifier: 120 V, 50/60 Hz
Heated Surface: 120 V, 0.5 A, 50/60 Hz, 65 W
- Minimum flat for door: 2-1/2" (64 mm)

Notes

Measure your actual product for rough-in details.

Install this product according to the installation instructions.

The hot water supply should be 70% of the capacity of the bath or greater. Installations will vary.

Provide one grounded electrical outlet within 24" (610 mm) of each component.

Control amplifier fits 16" (406 mm) center studs. 25' (7.6 m) cables are included.