



Features

- Integral flange.
- Right drain.
- Bask® heated surface creates spa-like relaxation with soothing warmth on your back, shoulders, and neck.
- Integral lumbar support and armrests for comfort.
- Integral apron with removable access panel.
- Textured bottom surface.
- 72" (1829 mm) x 36" (914 mm) x 20" (508 mm)

Material

- Acrylic

Installation

- Alcove

Recommended Accessories

- K-7166-AF Bath Drain
- K-24916 Wireless Music Kit
- K-37382 45" Rough-in Cable Bath Drain



Codes/Standards

- CSA B45.5/IAPMO Z124
- ASTM E162
- ASTM E662
- UL 1795
- Greenguard UL 2818 - Gold
- CARB P2





KOHLER® One-Year Limited Warranty

See website for detailed warranty information.

Available Color/Finishes

Color tiles intended for reference only.

| Color | Code | Description |
|-------|------|-------------|
|-------|------|-------------|

| | | |
|--|----|---------|
|  | 0 | White |
|  | 96 | Biscuit |
|  | 47 | Almond |
|  | NY | Dune |
|  | G9 | Sandbar |

No change in measurements if connected with drain illustrated. (K-7166-AF)

■ Recommended Faucet Area

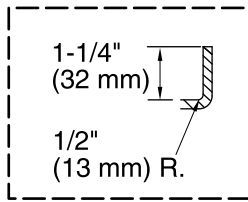

Integral Flange Detail

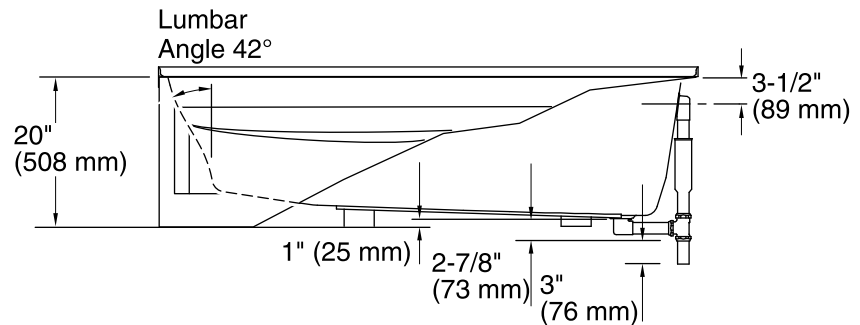
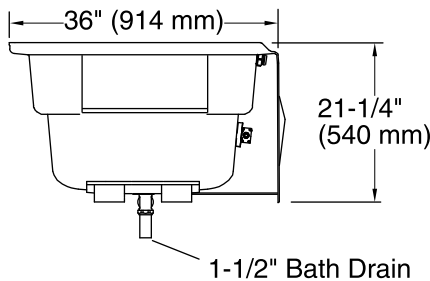
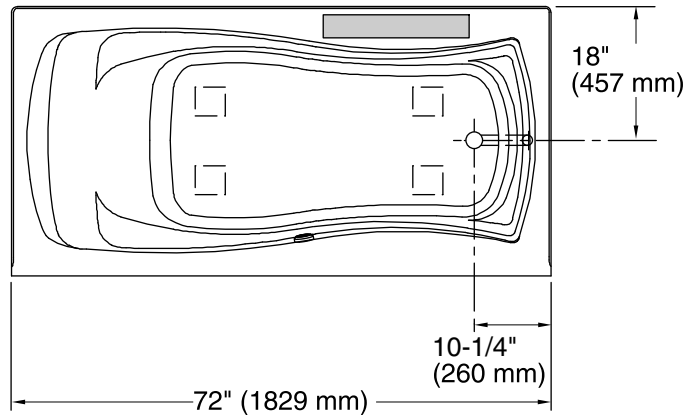

Required Electrical Service

One circuit required, protected with Class A Ground-Fault Circuit-Interrupter (GFCI) or Residual Current Device (RCD).

Heated Surface: 120 V, 15 A

Technical Information

All product dimensions are nominal.

Installation: 3-Wall Alcove

Drain location: Right

Basin area, bottom: 50" x 24" (1270 mm x 610 mm)

Basin area, top: 65" x 27" (1651 mm x 686 mm)

Weight: 77 lbs (34.9 kg)

Minimum floor load: 39 lbs/ft² (190.4 kg/m²)

Water depth: 14" (356 mm)

Water capacity: 72 gal (272.5 L)

Electrical component rating: Heated Surface: 120 V, 0.5 A, 60 Hz, 65 W

Minimum flat for door: 2-1/8" (54 mm)

Notes

Measure your actual product for rough-in details.

Install this product according to the installation instructions.

The hot water supply should be 70% of the capacity of the bath or greater. Installations will vary.

Provide one grounded electrical outlet within 24" (610 mm) of each component.