



### Features

- Integral flange.
- Left drain.
- Bask® heated surface creates spa-like relaxation with soothing warmth on your back, shoulders, and neck.
- Integral lumbar support and armrests for comfort.
- Integral apron with removable access panel.
- Textured bottom surface.
- 66" (1676 mm) x 36" (914 mm) x 21-1/4" (540 mm)

### Material

- Acrylic

### Hydrotherapy

- 120 BubbleMassage™ airjets.
- Zones of Control feature allows you to target massage to back, midsection, or feet.
- Automatic purge cycles remove residual water from air channels after use.
- Built-in 300 W heater.
- Lighted keypad control.

### Installation

- Alcove

### Recommended Accessories

- K-1446 Remote Installation Kit
- K-1491 Bath/Whirlpool Pillow
- K-1601 Bath/Whirlpool Footstop
- K-7166-AF Bath Drain
- K-24916 Wireless Music Kit



### Codes/Standards





ASME A112.19.7/CSA B45.10  
CSA B45.5/IAPMO Z124  
ASTM E162  
ASTM E662  
UL 1795  
Greenguard UL 2818 - Gold  
CARB P2

### KOHLER® One-Year Limited Warranty

See website for detailed warranty information.

### Available Color/Finishes

*Color tiles intended for reference only.*

Color	Code	Description
	0	White
	96	Biscuit
	47	Almond
	NY	Dune
	G9	Sandbar

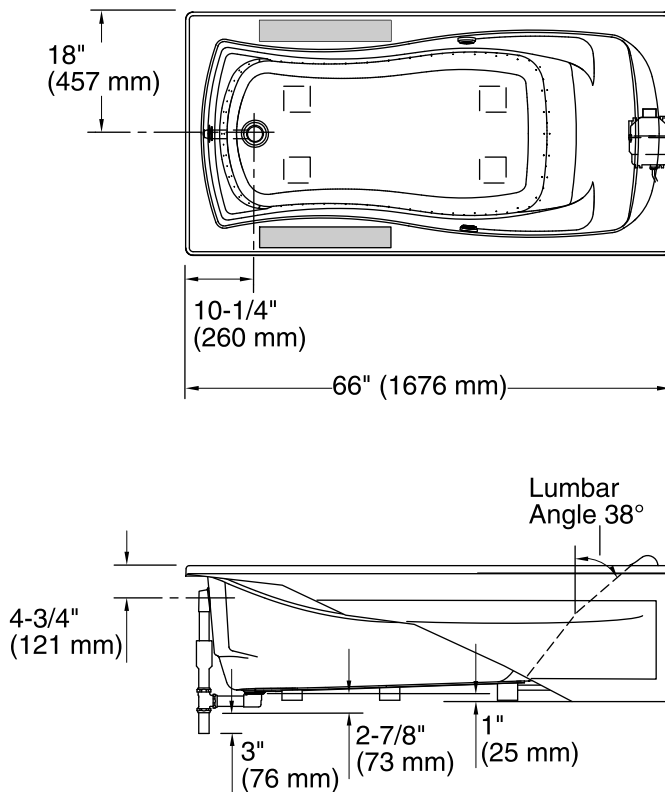

No change in measurements if conneted with drain illustrated. (K-7166-AF)

Recommended faucet area.

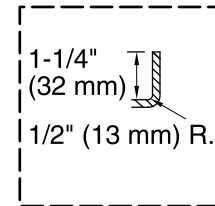

**Integral Flange Detail**

Blower Access  
30" (762 mm) W x  
15" (381 mm) H

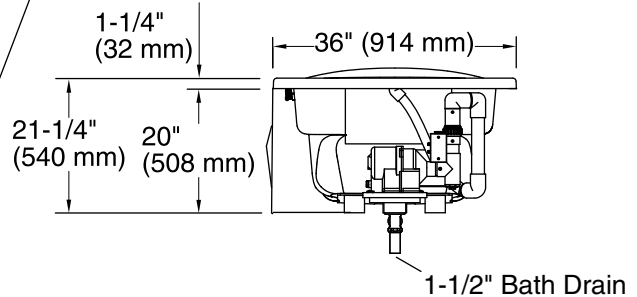

### Required Electrical Service

One dedicated circuit required, protected with Class A Ground-Fault Circuit-Interrupter (GFCI) or Residual Current Device (RCD).

Blower, Heated            120 V, 15 A, 60 Hz  
Surface:

### Technical Information

All product dimensions are nominal.

Installation:            3-Wall Alcove  
Drain location:        Left  
Basin area, bottom:    48" x 24" (1219 mm x 610 mm)  
Basin area, top:        59" x 30" (1499 mm x 762 mm)  
Weight:                115 lbs (52.2 kg)  
Minimum floor load:    42 lbs/ft<sup>2</sup> (205.1 kg/m<sup>2</sup>)  
Water depth:           14" (356 mm)  
Water capacity:        67 gal (253.6 L)  
Electrical component rating:  
Blower: 120 V, 10 A, 60 Hz, 300 W  
Heated Surface: 120 V, 0.5 A, 60 Hz, 65 W  
Minimum flat for door: 1-15/16" (49 mm)

### Notes

Measure your actual product for rough-in details.

Install this product according to the installation instructions.

The hot water supply should be 70% of the capacity of the bath or greater. Installations will vary.

Provide one grounded electrical outlet within 24" (610 mm) of each component.

If installing a rim-mount faucet, make sure there is no interference with drain overflow before drilling any holes. Consult local and national codes for minimum air gap requirements if installing a spout on the faucet deck.

Remote blower installation kit K-1446 is available for relocating the blower. Provide access for servicing the blower.

Do not relocate or alter the PVC tee or coiled flexible tubing connected to the blower. Follow the blower relocation instructions exactly.