



Features

- Integral flange.
- Left drain.
- VibrAcoustic® technology emits sound waves and offers a surround sound experience.
- Six transducers and a control amplifier with 25' (7.6 m) of wiring.
- High-resolution color screen in polished chrome.
- Integral lumbar support and armrests for comfort.
- Integral apron with removable access panel.
- Textured bottom surface.
- 72" (1829 mm) x 36" (914 mm) x 21-1/4" (540 mm)

Material

- Acrylic

Installation

- Alcove
- Syncs with devices enabled with BLUETOOTH® wireless technology including smart phones, MP3 players, tablets and laptops located up to 33 feet away.*

Recommended Accessories

- 1184460 Kit, UI Mounting
- K-1283 Apron
- K-1491 Bath/Whirlpool Pillow
- K-1601 Bath/Whirlpool Footstop
- K-7166-AF Bath Drain
- K-7213 27" Cable Bath Drain
- K-7214 27" Cable Bath Drain
- K-7259 Clearflo Bath Drain
- K-37382 45" Rough-in Cable Bath Drain



Codes/Standards

- CSA B45.5/IAPMO Z124
- ASTM E162
- ASTM E662
- UL 1795
- CSA C22.2 No. 218.2
- Greenguard UL 2818 - Gold
- CARB P2

KOHLER® One-Year Limited Warranty





See website for detailed warranty information.

*The BLUETOOTH® word mark and logos are registered trademarks owned by Bluetooth SIG, Inc. and any use of such marks by Kohler Co. is under license. Other trademarks and trade names are those of their respective owners.

Available Color/Finishes

Color tiles intended for reference only.

Color	Code	Description
-------	------	-------------

	0	White
	96	Biscuit
	47	Almond
	NY	Dune
	G9	Sandbar

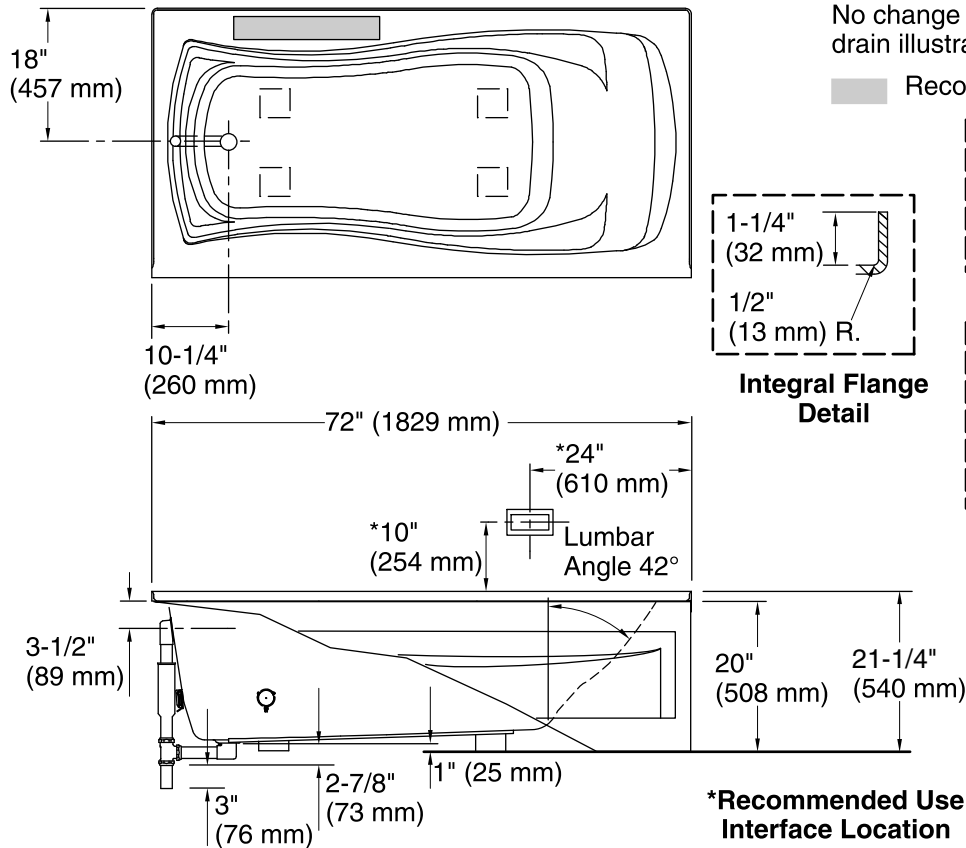

No change in measurements if connected with drain illustrated. (K-7166-AF)

■ Recommended Faucet Area

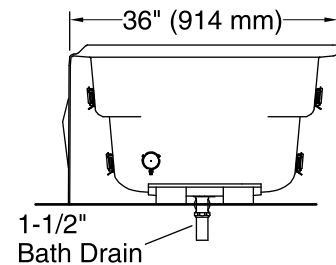
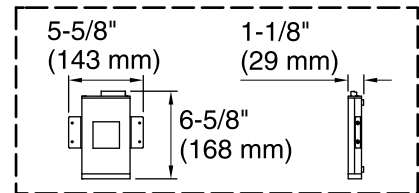
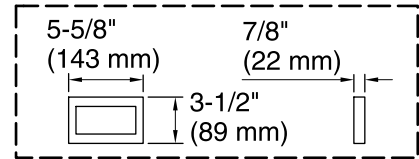

Required Electrical Service

One circuit required, protected with Class A Ground-Fault Circuit-Interrupter (GFCI) or Residual Current Device (RCD).

Amplifier: 120 V, 15 A, 50/60 Hz

Technical Information

All product dimensions are nominal.

Installation: 3-Wall Alcove

Drain location: Left

Basin area, bottom: 50" x 24" (1270 mm x 610 mm)

Basin area, top: 65" x 27" (1651 mm x 686 mm)

Weight: 88 lbs (39.9 kg)

Minimum floor load: 40 lbs/ft² (195.3 kg/m²)

Water depth: 14" (356 mm)

Water capacity: 72 gal (272.5 L)

Electrical component rating: Amplifier: 120 V, 1.1 A, 50/60 Hz

Amplifier channels: 2 at 15 W per channel
2 at 30 W per channel

Minimum flat for door: 2-1/8" (54 mm)

Notes

Measure your actual product for rough-in details.

Install this product according to the installation instructions.

If installing a rim-mount faucet, make sure there is no interference with drain overflow before drilling any holes. Consult local and national codes for minimum air gap requirements if installing a spout on the faucet deck.

Control amplifier fits 16" (406 mm) center studs. 25' (7.6 m) cables are included.