



Features

- End drain.
- 66" (1676 mm) x 36" (914 mm) x 20" (508 mm)
- Bask® heated surface creates spa-like relaxation with soothing warmth on your back, shoulders, and neck.
- Textured bottom surface.

Material

- Acrylic

Installation

- Drop-in

Recommended Accessories

- K-7161-AF Bath Drain
- K-24916 Wireless Music Kit
- K-37380 30" Rough-in Cable Bath Drain
- K-37383 30" Rough-in Cable Bath Drain

Components

Additional included component/s: 40" (1016 mm) cable.



Codes/Standards





- CSA B45.5/IAPMO Z124
- ASTM E162
- ASTM E662
- UL 1795
- Greenguard UL 2818 - Gold

KOHLER® One-Year Limited Warranty

See website for detailed warranty information.

Available Color/Finishes

Color tiles intended for reference only.

| Color | Code | Description |
|--|------|-------------|
|  | 0 | White |
|  | 96 | Biscuit |
|  | 47 | Almond |
|  | NY | Dune |
|  | G9 | Sandbar |

No change in measurements if connected with drain illustrated. (K-7161-AF)

■ Recommended faucet area.

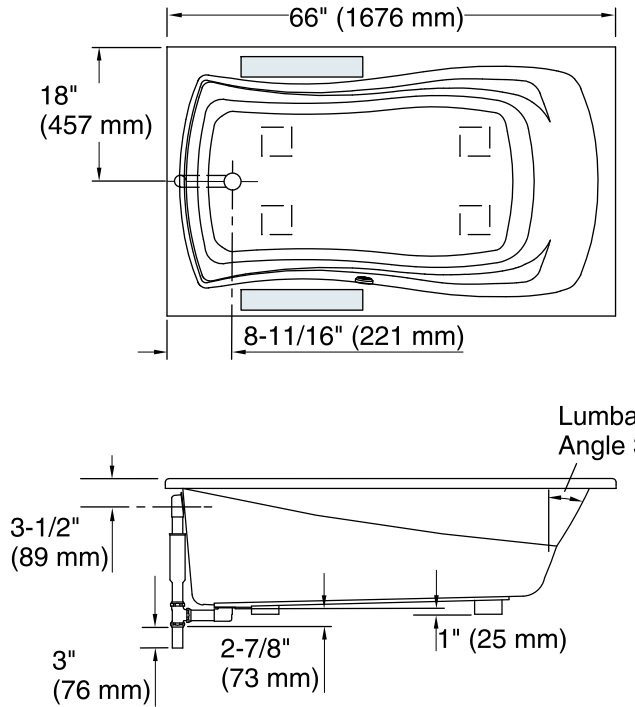

Access Panel
20" (508 mm) L x
15" (381 mm) H Min

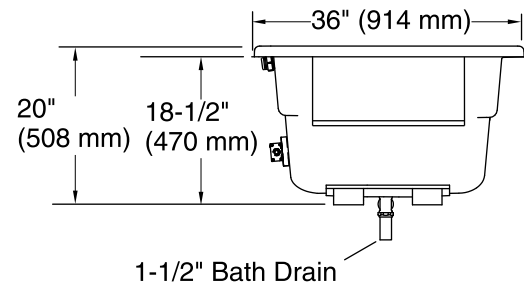
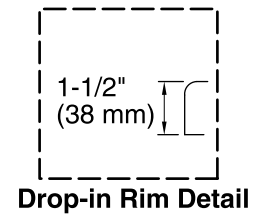

Required Electrical Service

One circuit required, protected with Class A Ground-Fault Circuit-Interrupter (GFCI) or Residual Current Device (RCD).

Heated Surface: 120 V, 15 A

Technical Information

All product dimensions are nominal.

| | |
|------------------------------|---|
| Installation: | Drop-in |
| Drain location: | End |
| Basin area, bottom: | 48" x 24" (1219 mm x 610 mm) |
| Basin area, top: | 59" x 30" (1499 mm x 762 mm) |
| Weight: | 65 lbs (29.5 kg) |
| Minimum floor load: | 39 lbs/ft ² (190.4 kg/m ²) |
| Water depth: | 14" (356 mm) |
| Water capacity: | 67 gal (253.6 L) |
| Cutout: | Drop-in, 64" x 34" (1626 mm x 864 mm) |
| Electrical component rating: | Heated Surface: 120 V, 0.5 A, 60 Hz, 65 W |
| Minimum flat for door: | 1-15/16" (49 mm) |

Notes

Measure your actual product for rough-in details.

Install this product according to the installation instructions.

The hot water supply should be 70% of the capacity of the bath or greater. Installations will vary.

Provide one grounded electrical outlet within 24" (610 mm) of each component.