



Features

- Integral flange.
- Left drain.
- VibrAcoustic® technology emits sound waves and offers a surround sound experience.
- Six transducers and a control amplifier with 25' (7.6 m) of wiring.
- High-resolution color screen in polished chrome.
- Integral lumbar support and armrests for comfort.
- Integral apron with removable access panel.
- Textured bottom surface.
- 66" (1676 mm) x 36" (914 mm) x 21-1/4" (540 mm)

Material

- Acrylic

Installation

- Alcove

Recommended Accessories

- 1184460 Kit, UI Mounting
- K-1234 Apron
- K-1491 Bath/Whirlpool Pillow
- K-1601 Bath/Whirlpool Footstop
- K-7161-AF Bath Drain
- K-7213 27" Cable Bath Drain
- K-7214 27" Cable Bath Drain
- K-7259 Clearflo Bath Drain
- K-7272 PVC Slotted Overflow Bath Drain



Codes/Standards





- CSA B45.5/IAPMO Z124
- ASTM E162
- ASTM E662
- UL 1795
- CSA C22.2 No. 218.2
- Greenguard UL 2818 - Gold
- CARB P2

KOHLER® One-Year Limited Warranty

See website for detailed warranty information.

Available Color/Finishes

Color tiles intended for reference only.

Color	Code	Description
	0	White
	96	Biscuit
	47	Almond
	NY	Dune
	G9	Sandbar

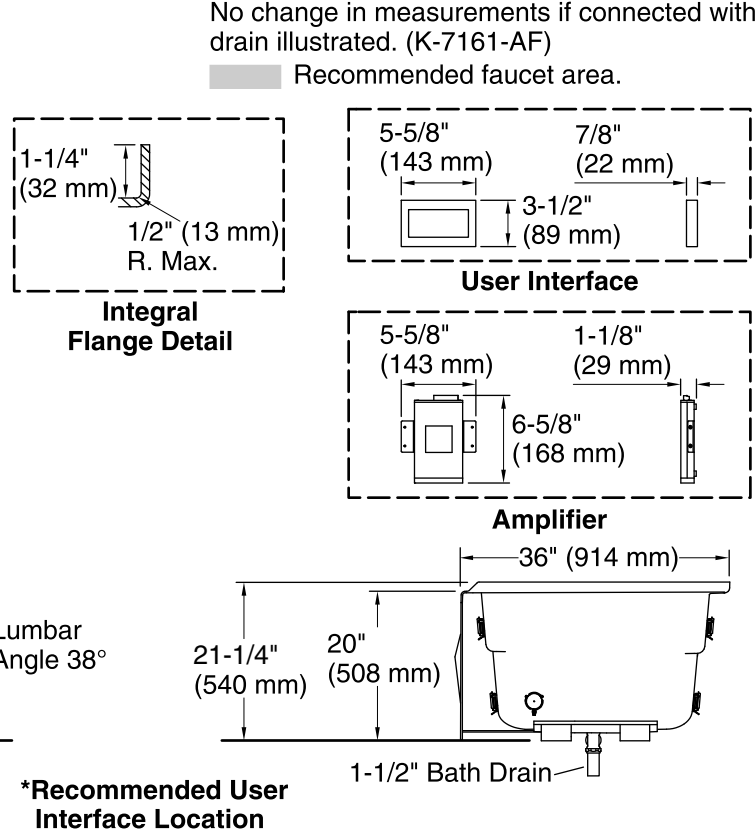
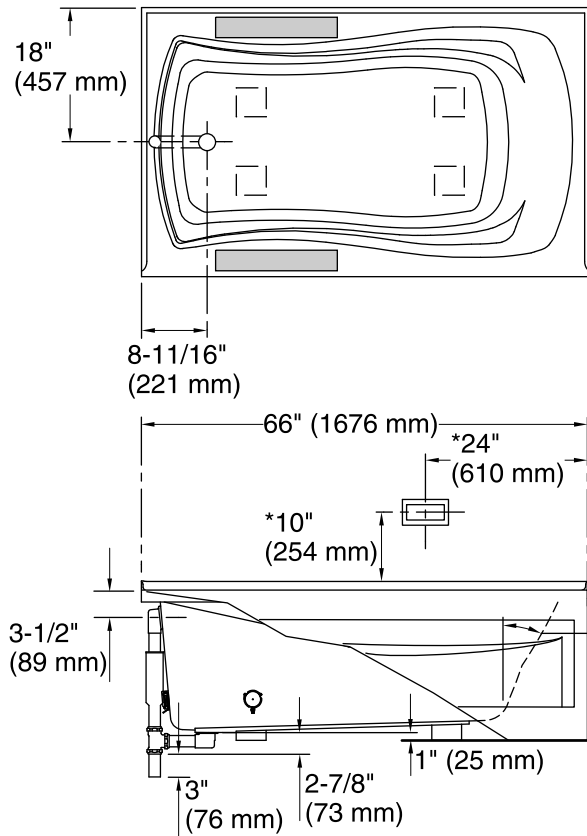

No change in measurements if connected with drain illustrated. (K-7161-AF)

■ Recommended faucet area.

Required Electrical Service

One circuit required, protected with Class A Ground-Fault Circuit-Interrupter (GFCI) or Residual Current Device (RCD).

Amplifier: 120 V, 15 A, 50/60 Hz

Technical Information

All product dimensions are nominal.

Installation: 3-Wall Alcove

Drain location: Left

Basin area, bottom: 48" x 24" (1219 mm x 610 mm)

Basin area, top: 59" x 30" (1499 mm x 762 mm)

Weight: 76 lbs (34.5 kg)

Minimum floor load: 40 lbs/ft² (195.3 kg/m²)

Water depth: 14" (356 mm)

Water capacity: 67 gal (253.6 L)

Electrical component rating: Amplifier: 120 V, 50/60 Hz

Minimum flat for door: 1-15/16" (49 mm)

Notes

Measure your actual product for rough-in details.

Install this product according to the installation instructions.

The hot water supply should be 70% of the capacity of the bath or greater. Installations will vary.

Provide one grounded electrical outlet within 24" (610 mm) of each component.

If installing a rim-mount faucet, make sure there is no interference with drain overflow before drilling any holes. Consult local and national codes for minimum air gap requirements if installing a spout on the faucet deck.

Control amplifier fits 16" (406 mm) center studs. 25' (7.6 m) cables are included.