



Features

- End drain.
- Slotted overflow for deep soaking.
- VibrAcoustic® technology emits sound waves and offers a surround sound experience.
- Six transducers and a control amplifier with 25' (7.6 m) of wiring.
- High-resolution color screen in polished chrome.
- Integral lumbar support.
- 66" (1676 mm) x 32" (813 mm) x 22" (559 mm)

Material

- Acrylic

Installation

- Drop-in or under-mount.
- Syncs with devices enabled with BLUETOOTH® wireless technology including smart phones, MP3 players, tablets and laptops located up to 33 feet away.*

Required Accessories

K-7271 Brass Slotted Overflow Bath Drain

or

K-7272 PVC Slotted Overflow Bath Drain

Recommended Accessories

1184460 Kit, UI Mounting

K-1491 Bath/Whirlpool Pillow

K-1601 Bath/Whirlpool Footstop

K-550 Under-mount Installation Kit



Codes/Standards

ASME A112.19.7/CSA B45.10

CSA B45.5/IAPMO Z124

ASTM E162

ASTM E662

UL 1795

Greenguard UL 2818 - Gold











KOHLER® One-Year Limited Warranty

See website for detailed warranty information.

*The BLUETOOTH® word mark and logos are registered trademarks owned by Bluetooth SIG, Inc. and any use of such marks by Kohler Co. is under license. Other trademarks and trade names are those of their respective owners.

Available Color/Finishes

Color tiles intended for reference only.

Color	Code	Description
	0	White
	96	Biscuit
	47	Almond
	NY	Dune
	95	Ice™ Grey
	G9	Sandbar
	33	Mexican Sand™
	K4	Cashmere
	58	Thunder™ Grey
	7	Black Black™

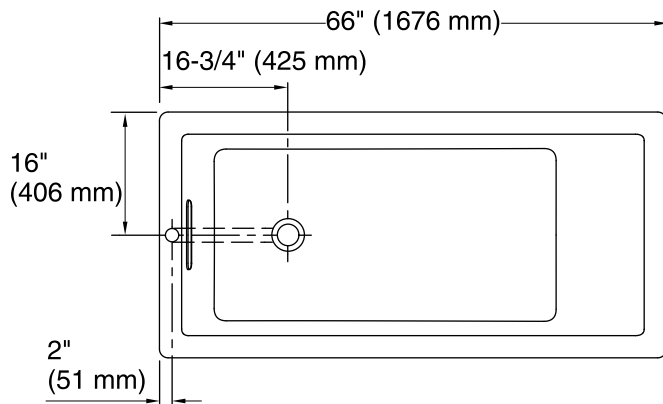

No change in measurement if connected with drain illustrated. (K-7272)

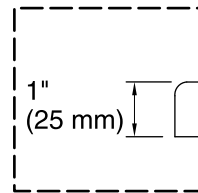

Drop-In Rim Detail

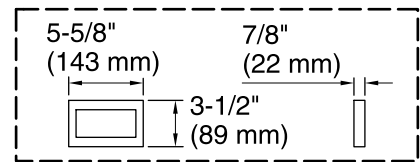

User Interface

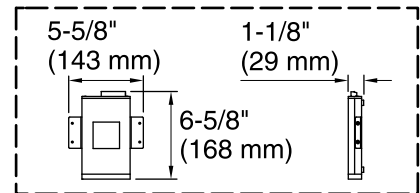

Amplifier

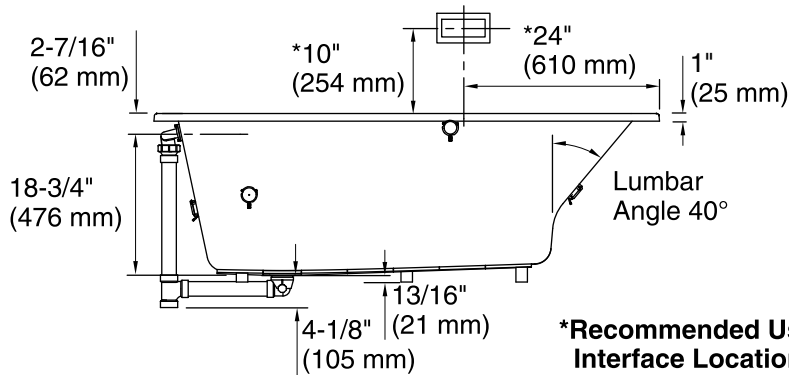

***Recommended User Interface Location**

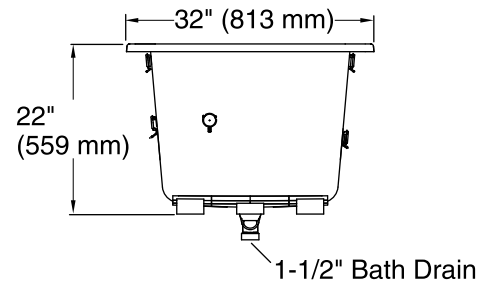

Required Electrical Service

One circuit required, protected with Class A Ground-Fault Circuit-Interrupter (GFCI) or Residual Current Device (RCD).

Amplifier: 120 V, 15 A, 50/60 Hz

Technical Information

All product dimensions are nominal.

Installation:	Drop-in, Under-mount
Drain location:	End
Basin area, bottom:	44-1/2" x 22-5/16" (1130 mm x 567 mm)
Basin area, top:	59-5/8" x 25-1/2" (1514 mm x 648 mm)
Weight:	91 lbs (41.3 kg)
Minimum floor load:	58 lbs/ft ² (283.2 kg/m ²)
Water depth:	18" (457 mm)
Water capacity:	85 gal (321.8 L)
Cutout:	Drop-in, 64-1/2" x 30-1/2" (1638 mm x 775 mm)
Electrical component rating:	Amplifier: 120 V, 1.1 A, 50/60 Hz
Amplifier channels:	2 at 15 W per channel 2 at 30 W per channel
Minimum flat for door:	2-1/2" (64 mm)

Notes

Measure your actual product for rough-in details.

Install this product according to the installation instructions.

Control amplifier fits 16" (406 mm) center studs. 25' (7.6 m) cables are included.