

## Features

- Integral flange.
- Left drain.
- Textured bottom surface.
- One-piece construction.
- Compliments traditional and contemporary bathroom designs.
- Coordinates with Choreograph™ walls.

## Material

- Cast iron with Safeguard® finish.

## Installation

- Alcove

## Recommended Accessories

K-9132 Shower Drain  
1647-PC  
1708  
K-1733 9 kW Steam Generator  
K-702206-G54 Frameless Sliding Shower Door  
K-702206-G73 Frameless Sliding Shower Door  
K-702206-L Frameless Sliding Shower Door  
K-702207-L Frameless Sliding Shower Door  
K-702217-L Frameless Sliding Shower Door  
K-705705-L Frameless Pivot Shower Door  
K-705711-L Frameless Pivot Shower Door  
K-705717-L Frameless Pivot Shower Door  
K-705723-L Frameless Pivot Shower Door  
K-705729-L Frameless Pivot Shower Door  
K-705741-L Frameless Pivot Shower Door  
K-705810-L Semi-Frameless Pivot Shower Door  
K-705811-L Semi-Frameless Pivot Shower Door  
K-705824-L Semi-Frameless Pivot Shower Door  
K-705825-L Semi-Frameless Pivot Shower Door  
K-706009-D3 Frameless Sliding Shower Door  
K-706009-L Frameless Sliding Shower Door  
K-706012-L Frameless Sliding Shower Door  
K-706013-L Frameless Sliding Shower Door  
K-706015-D3 Frameless Sliding Shower Door  
K-706015-L Frameless Sliding Shower Door  
K-706019-L Frameless Sliding Shower Door



## Codes/Standards















ASME A112.19.1/CSA B45.2  
ASTM F462  
ASTM F462

## KOHLER® Lifetime Limited Warranty for Cast Iron Components

See website for detailed warranty information.

## Available Color/Finishes

*Color tiles intended for reference only.*

Color	Code	Description
	0	White
	FF	Sea Salt™
	96	Biscuit
	47	Almond
	FD	Cane Sugar™
	NY	Dune
	95	Ice™ Grey
	G9	Sandbar
	33	Mexican Sand™
	K4	Cashmere
	FT	Basalt
	58	Thunder™ Grey
	KA	Black 'n Tan
	7	Black Black™

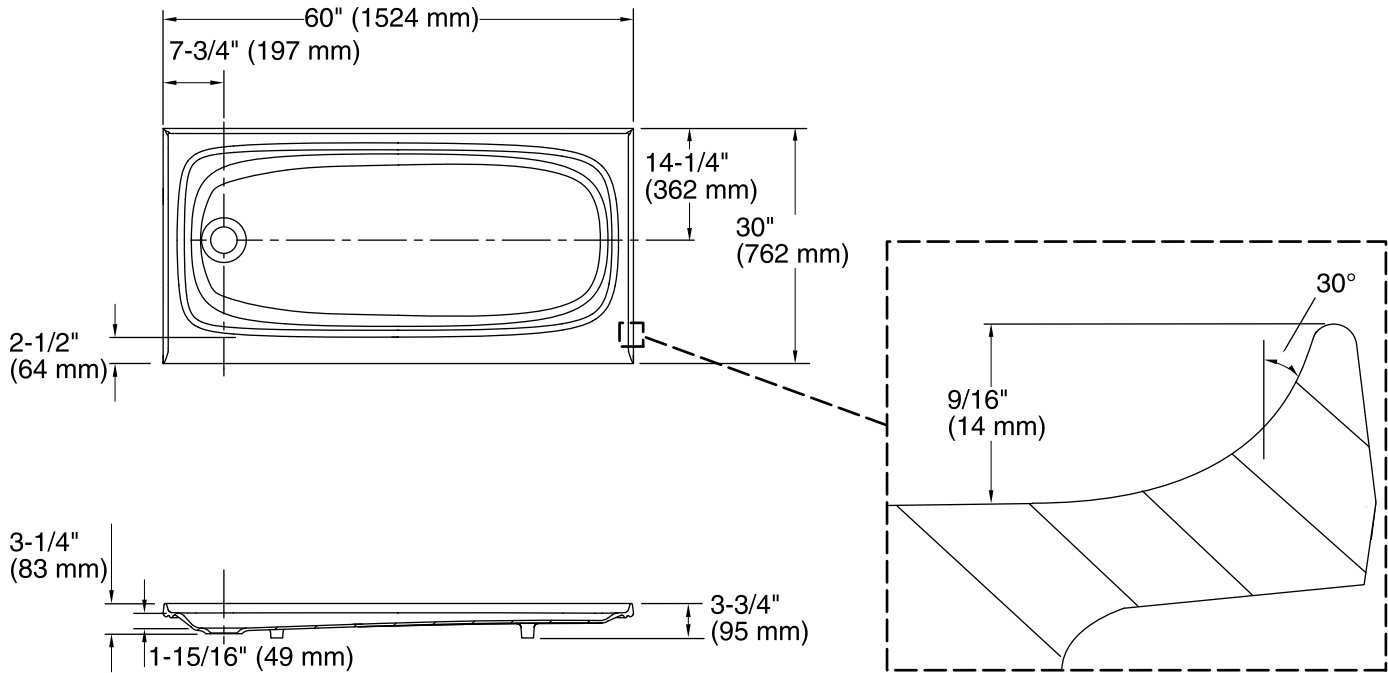

## Technical Information

All product dimensions are nominal.

Installation: 3-Wall Alcove  
 Drain location: Left  
 Drain hole diameter: 3-3/8" (86 mm)  
 Weight: 193 lbs (87.5 kg)  
 Minimum floor load: 40 lbs/ft<sup>2</sup> (195.3 kg/m<sup>2</sup>)  
 Minimum flat for door: 0" (0 mm)

## Notes

Measure your actual product for rough-in details.

Install this product according to the installation instructions.

KOHLER steam generator/control kit is designed for use with this product. Kohler Co. shall not be responsible for problems encountered due to the installation and use of other manufacturer's steam generators.