

## Features

- 36-inch minimum base cabinet width.
- KOHLER cast iron.
- Acid-resistant enamel finish.
- Under-mount.
- Single faucet hole.
- Smart Divide® lowered divider.
- Large/small bowl.
- 33" (838 mm) x 21-1/8" (537 mm)

## Recommended Accessories

K- 9000 P-Trap

## Optional Accessories

K- 5807 36" Under-mount Sink Kit  
K- 8801 Sink Strainer

## Components

Product includes:

K- 6163 Sink Rack  
K- 6164 Sink Rack  
K- 6165 Cutting Board  
K- 6166 Colander  
1054375 Under-mount Sink Kit, 23"



## Codes/Standards











ASME A112.19.1/CSA B45.2

## KOHLER® Lifetime Limited Warranty for Cast Iron Components

See website for detailed warranty information.

## Available Color/Finishes

*Color tiles intended for reference only.*

Color	Code	Description
	0	White
	FF	Sea Salt™
	96	Biscuit
	47	Almond
	FD	Cane Sugar™
	NY	Dune
	95	Ice™ Grey
	G9	Sandbar
	33	Mexican Sand™
	K4	Cashmere
	FT	Basalt
	58	Thunder™ Grey
	20	Suede
	KA	Black 'n Tan
	FP	Caviar
	7	Black Black™

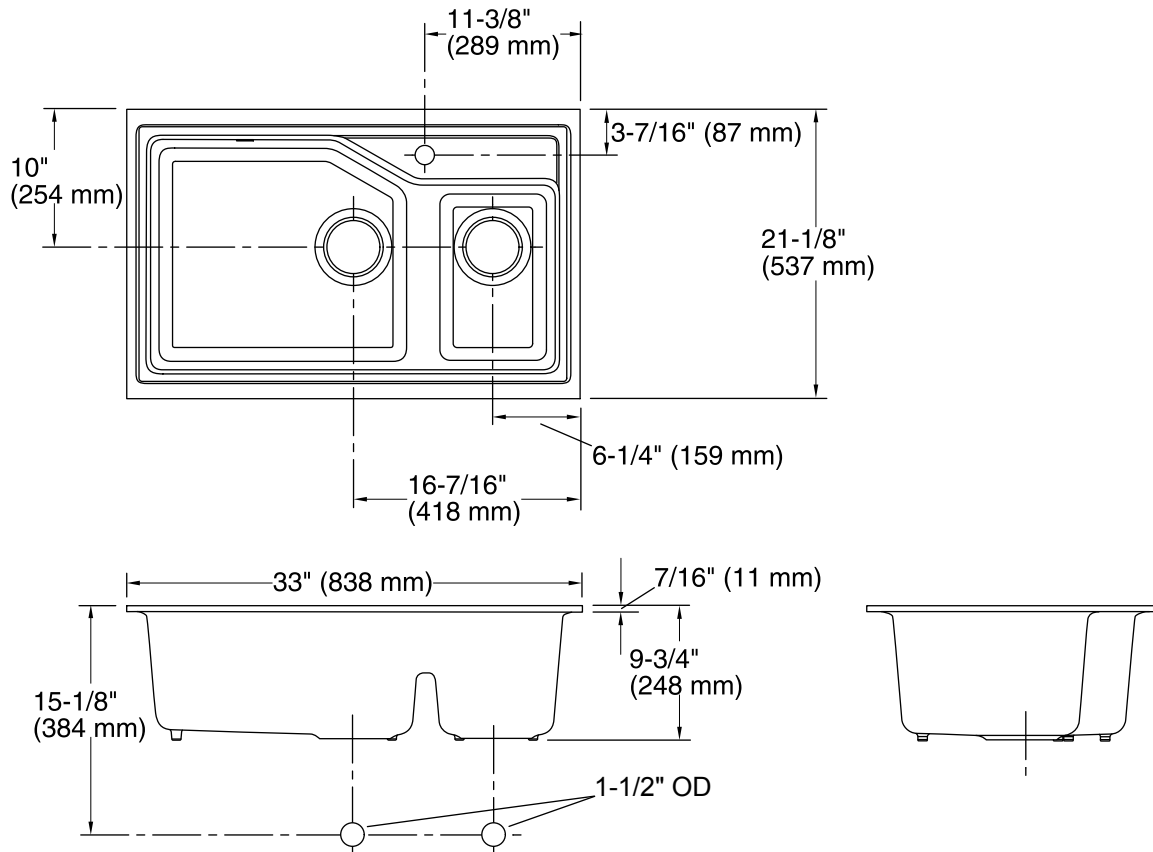

## Technical Information

All product dimensions are nominal.

Installation:	Under-mount
Bowl area (Left)	Length: 18-15/16" (481 mm) Width: 16-3/4" (425 mm) Bowl depth: 9" (229 mm) Water depth: 9" (229 mm)
Bowl area (Right)	Length: 8-11/16" (221 mm) Width: 13-1/2" (343 mm) Bowl depth: 9" (229 mm) Water depth: 9" (229 mm)
Number of deck holes:	1
Faucet hole(s):	1-3/8" (35 mm)
Drain hole:	3-7/8" (98 mm)
Template:	Under-mount, 1106715-7, required, included

## Notes

Install this product according to the installation guide.

**NOTICE:** The countertop manufacturer or cutter must use the cut-out template provided with the product, or a current one provided by the Kohler Co. (Call 1-800-4-KOHLER.) Kohler Co. is not responsible for cut-out errors when the incorrect cut-out template is used.