



Features

- End drain.
- Integral lumbar support and armrests for comfort.
- Textured bottom surface.
- 60" (1524 mm) x 36" (914 mm) x 20" (508 mm)

Material

- Acrylic

Installation

- Drop-in

Recommended Accessories

- K-1278 Removable Apron
- K-1491 Bath/Whirlpool Pillow
- K-7161-AF Bath Drain
- K-24916 Wireless Music Kit
- K-1601 Bath/Whirlpool Footstop
- K-7259 Clearflo Bath Drain
- K-37380 30" Rough-in Cable Bath Drain
- K-37383 30" Rough-in Cable Bath Drain
- K-702200-G54 Frameless Sliding Bath Door
- K-702200-G73 Frameless Sliding Bath Door
- K-702200-L Frameless Sliding Bath Door
- K-702205-L Frameless Sliding Bath Door
- K-706000-D3 Frameless Sliding Bath Door
- K-706000-L Frameless Sliding Bath Door
- K-706003-L Frameless Sliding Bath Door
- K-706004-D3 Frameless Sliding Bath Door
- K-706004-L Frameless Sliding Bath Door
- K-706007-L Frameless Sliding Bath Door



Codes/Standards

- CSA B45.5/IAPMO Z124
- ASTM E162
- ASTM E662
- Greenguard UL 2818 - Gold





KOHLER® One-Year Limited Warranty

See website for detailed warranty information.

Available Color/Finishes

Color tiles intended for reference only.

Color Code Description

	0	White
	96	Biscuit
	47	Almond
	NY	Dune
	G9	Sandbar

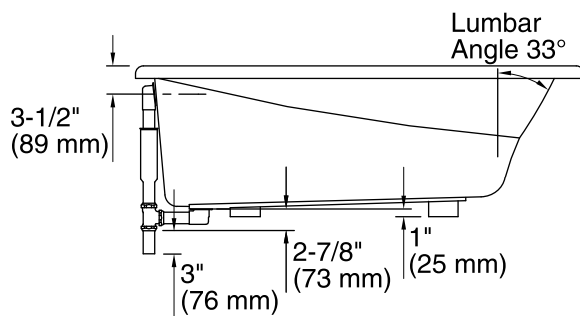
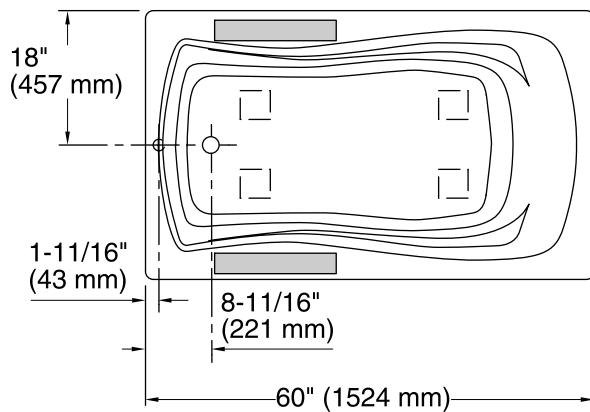

No change in measurements if connected with drain illustrated. (K-7161-AF)

Recommended faucet area

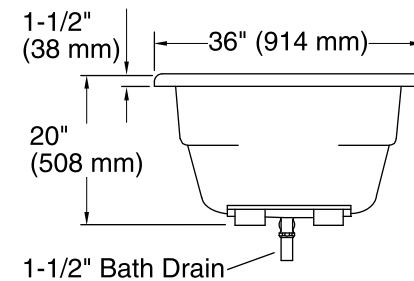
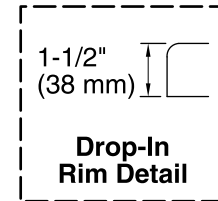

Technical Information

All product dimensions are nominal.

Installation:	Drop-in
Drain location:	End
Basin area, bottom:	46" x 24" (1168 mm x 610 mm)
Basin area, top:	54" x 27" (1372 mm x 686 mm)
Weight:	62 lbs (28.1 kg)
Minimum floor load:	41 lbs/ft ² (200.2 kg/m ²)
Water depth:	14" (356 mm)
Water capacity:	63 gal (238.5 L)
Cutout:	Drop-in, 58" x 34" (1473 mm x 864 mm)
Minimum flat for door:	2" (50 mm)

Notes

Measure your actual product for rough-in details.

Install this product according to the installation instructions.

The hot water supply should be 70% of the capacity of the bath or greater. Installations will vary.

If installing a rim-mount faucet, make sure there is no interference with drain overflow before drilling any holes. Consult local and national codes for minimum air gap requirements if installing a spout on the faucet deck.