



Features

- Integral flange.
- Left drain.
- Integral lumbar support and armrests for comfort.
- Textured bottom surface.
- 72" (1829 mm) x 36" (914 mm) x 20" (508 mm)

Material

- Acrylic

Hydrotherapy

- Single-speed whirlpool offers 6 fully adjustable hydro-massage jets for water flow and direction.
- Pump with air switch for whirlpool.

Installation

- Alcove

Recommended Accessories

- K-1283 Apron
- K-1491 Bath/Whirlpool Pillow
- K-7166-AF Bath Drain
- K-9696 Whirlpool 6-Jet Trim Kit
- K-24916 Wireless Music Kit
- K-1601 Bath/Whirlpool Footstop
- K-7213 27" Cable Bath Drain
- K-7214 27" Cable Bath Drain
- K-7259 Clearflo Bath Drain
- K-37382 45" Rough-in Cable Bath Drain



Codes/Standards





- ASME A112.19.7/CSA B45.10
- CSA B45.5/IAPMO Z124
- ASTM E162
- ASTM E662
- UL 1795
- Greenguard UL 2818 - Gold
- CARB P2

KOHLER® One-Year Limited Warranty

See website for detailed warranty information.

Available Color/Finishes

Color tiles intended for reference only.

Color	Code	Description
	0	White
	96	Biscuit
	47	Almond
	NY	Dune
	G9	Sandbar

Pump/Control Access (If Apron Is Not Used):
20" (508 mm) W x 15" (381 mm) H

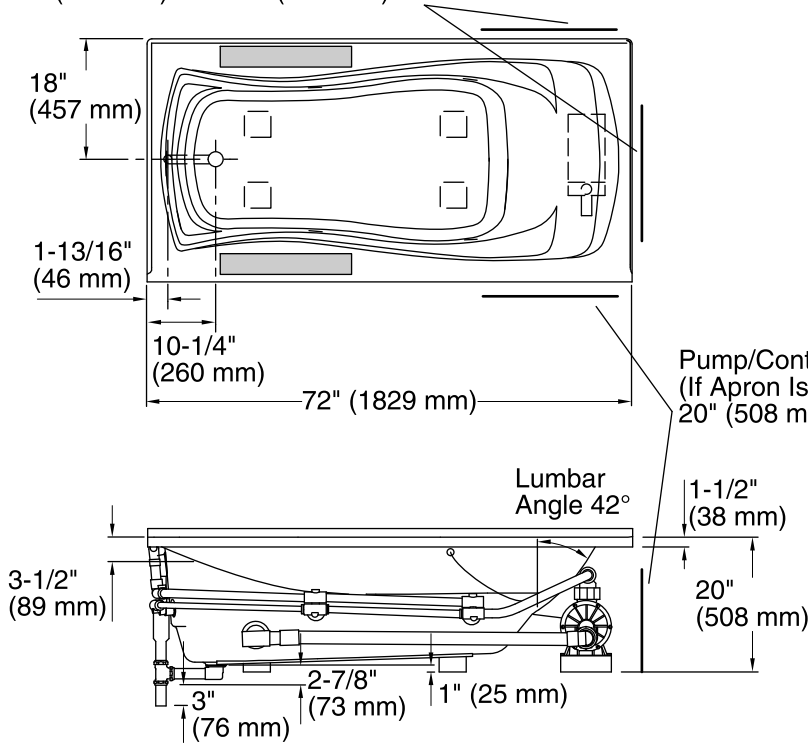

No change in measurements if connected with drain illustrated. (K-11677)

Recommended Faucet Area

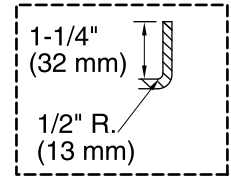

Integral Flange Detail

Pump/Control Access
(If Apron Is Not Used):
20" (508 mm) W x 15" (381 mm) H

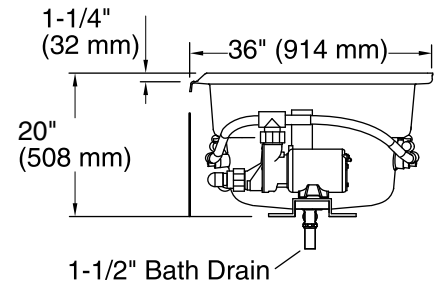

Required Electrical Service

One dedicated circuit required, protected with Class A Ground-Fault Circuit-Interrupter (GFCI) or Residual Current Device (RCD).

Pump: 120 V, 15 A, 60 Hz

Technical Information

All product dimensions are nominal.

Installation: 3-Wall Alcove
 Drain location: Left
 Basin area, bottom: 50" x 24" (1270 mm x 610 mm)
 Basin area, top: 65" x 27" (1651 mm x 686 mm)
 Weight: 110 lbs (49.9 kg)
 Minimum floor load: 41 lbs/ft² (200.2 kg/m²)
 Water depth: 14" (356 mm)
 Water capacity: 72 gal (272.5 L)
 Electrical component rating: Pump: 120 V, 7.5 A, 60 Hz
 Pump speed: Single
 Minimum flat for door: 2-1/8" (54 mm)

Notes

Measure your actual product for rough-in details.

Install this product according to the installation instructions.

The hot water supply should be 70% of the capacity of the bath or greater. Installations will vary.

Provide one grounded electrical outlet within 24" (610 mm) of each component.

If installing a rim-mount faucet, make sure there is no interference with drain overflow before drilling any holes. Consult local and national codes for minimum air gap requirements if installing a spout on the faucet deck.