



### Features

- End drain.
- Integral lumbar support and armrests for comfort.
- Textured bottom surface.
- 72" (1829 mm) x 36" (914 mm) x 20" (508 mm)

### Material

- Acrylic

### Hydrotherapy

- Single-speed whirlpool offers 6 fully adjustable hydro-massage jets for water flow and direction.
- Pump with air switch for whirlpool.
- Multiple pump location options give you more choices for installation and access.
- Built-in 1500 W heater.

### Installation

- Drop-in

### Recommended Accessories

- K-1283 Apron
- K-1491 Bath/Whirlpool Pillow
- K-7166-AF Bath Drain
- K-9696 Whirlpool 6-Jet Trim Kit
- K-24916 Wireless Music Kit
- K-1601 Bath/Whirlpool Footstop
- K-7213 27" Cable Bath Drain
- K-7214 27" Cable Bath Drain
- K-7259 Clearflo Bath Drain
- K-37382 45" Rough-in Cable Bath Drain



### Codes/Standards

ASME A112.19.7/CSA B45.10  
CSA B45.5/IAPMO Z124  
ASTM E162  
ASTM E662  
UL 1795  
Greenguard UL 2818 - Gold  
CARB P2





### KOHLER® One-Year Limited Warranty

See website for detailed warranty information.

### Available Color/Finishes

*Color tiles intended for reference only.*

| Color | Code | Description |
|-------|------|-------------|
|-------|------|-------------|

|  |    |         |
|--|----|---------|
|  | 0  | White   |
|  | 96 | Biscuit |
|  | 47 | Almond  |
|  | NY | Dune    |
|  | G9 | Sandbar |

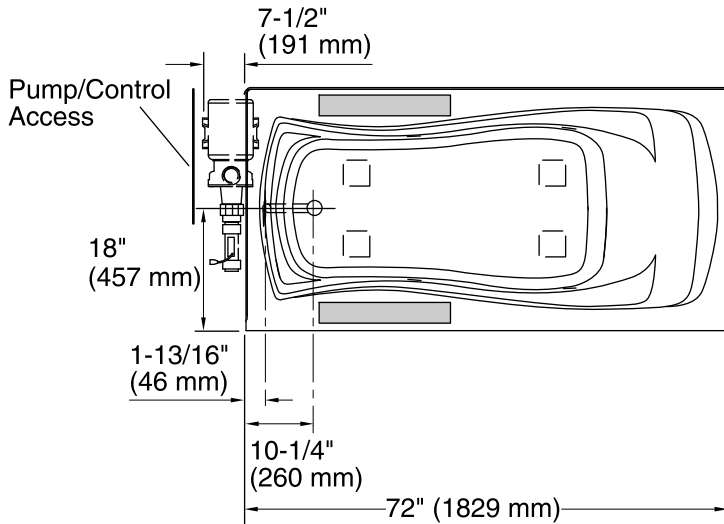

No change in measurements if connected with drain illustrated. (K-7166-AF)

Recommended Faucet Area

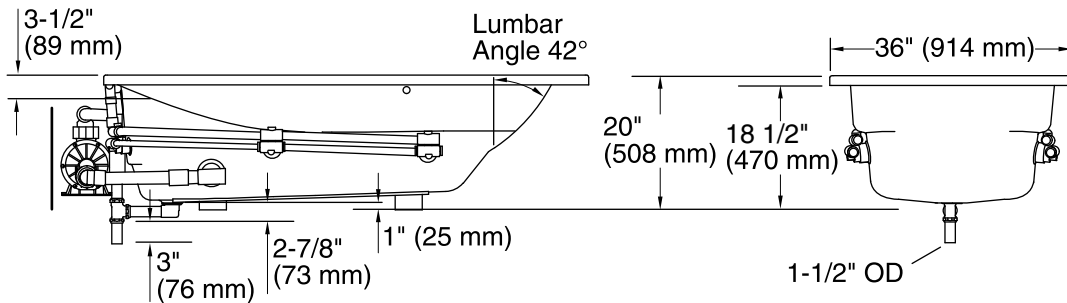
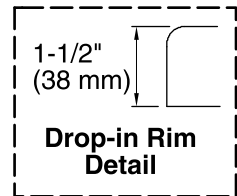

### Required Electrical Service

Two dedicated circuits required, protected with Class A Ground-Fault Circuit-Interrupter (GFCI) or Residual Current Device (RCD).

Pump: 120 V, 15 A, 60 Hz  
Heater: 120 V, 15 A, 60 Hz

### Technical Information

All product dimensions are nominal.

Installation: Drop-in  
Drain location: End  
Basin area, bottom: 50" x 24" (1270 mm x 610 mm)  
Basin area, top: 65" x 27" (1651 mm x 686 mm)  
Weight: 115 lbs (52.2 kg)  
Minimum floor load: 41 lbs/ft<sup>2</sup> (200.2 kg/m<sup>2</sup>)  
Water depth: 14" (356 mm)  
Water capacity: 72 gal (272.5 L)  
Cutout: Drop-in, 70" x 34" (1778 mm x 864 mm)  
Electrical component rating: Pump: 120 V, 7.5 A, 60 Hz  
Heater: 120 V, 12.5 A, 60 Hz, 1500 W  
Pump speed: Single

### Notes

Measure your actual product for rough-in details.

Install this product according to the installation instructions.

The hot water supply should be 70% of the capacity of the bath or greater. Installations will vary.

Provide one grounded electrical outlet within 24" (610 mm) of each component.

Pump must be relocated to custom position at the time of installation. Provide adequate clearance.

If installing a rim-mount faucet, make sure there is no interference with drain overflow before drilling any holes. Consult local and national codes for minimum air gap requirements if installing a spout on the faucet deck.