



### Features

- Integral flange.
- Comfort Depth® design offers a 19" (483 mm) step-over height.
- Left drain.
- Slotted overflow for deep soaking.
- Coordinates with other products in the Archer® collection.
- 72" (1829 mm) x 36" (914 mm) x 19" (483 mm)
- Integral lumbar support and armrests for comfort.
- Textured bottom surface.
- Integral apron.

### Material

- Acrylic

### Installation

- Alcove

### Required Accessories

K-7271 Brass Slotted Overflow Bath Drain

or

K-7272 PVC Slotted Overflow Bath Drain

### Recommended Accessories

K-9529 Removable Bath Seat



### ADA

### Codes/Standards

CSA B45.5/IAPMO Z124

ASTM E162

ASTM E662

Greenguard UL 2818 - Gold

ADA











ICC/ANSI A117.1

### KOHLER® One-Year Limited Warranty

See website for detailed warranty information.

### Available Color/Finishes

*Color tiles intended for reference only.*

Color	Code	Description
	0	White
	96	Biscuit
	47	Almond
	NY	Dune
	95	Ice™ Grey
	G9	Sandbar
	33	Mexican Sand™
	K4	Cashmere
	58	Thunder™ Grey
	7	Black Black™

No change in measurements if connected with drain illustrated. (K-7272)

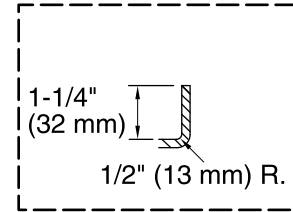
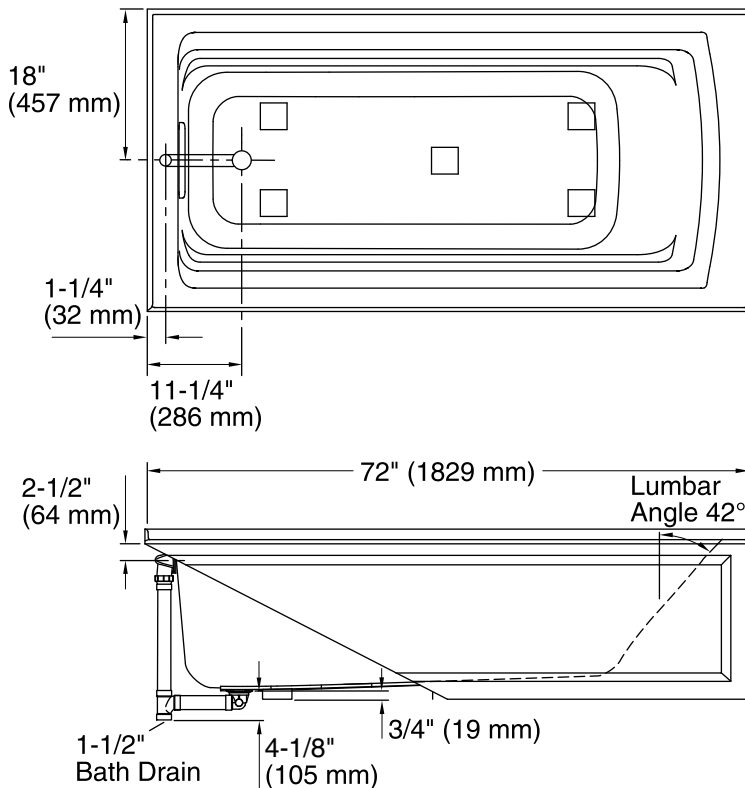

**Integral Flange Detail**

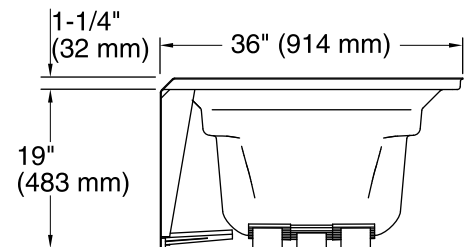

### Technical Information

All product dimensions are nominal.

Installation:	3-Wall Alcove
Drain location:	Left
Basin area, bottom:	51-3/8" x 21" (1305 mm x 533 mm)
Basin area, top:	64-1/2" x 30-1/2" (1638 mm x 775 mm)
Weight:	80 lbs (36.3 kg)
Minimum floor load:	40 lbs/ft <sup>2</sup> (195.3 kg/m <sup>2</sup> )
Water depth:	15" (381 mm)
Water capacity:	72 gal (272.5 L)
Minimum flat for door:	1-9/16" (40 mm)

### Notes

Measure your actual product for rough-in details.

Install this product according to the installation instructions.

The hot water supply should be 70% of the capacity of the bath or greater. Installations will vary.

ADA compliant when installed to the specific requirements of these regulations.