



Features

- Integral flange.
- Comfort Depth® design offers a 19" (483 mm) step-over height.
- Left drain.
- Slotted overflow for deep soaking.
- Integral lumbar support.
- 60" (1524 mm) x 30" (762 mm) x 19" (483 mm)

Material

- Acrylic

Installation

- Alcove

Required Accessories

K-7271 Brass Slotted Overflow Bath Drain

or

K-7272 PVC Slotted Overflow Bath Drain

Recommended Accessories

K-1491 Bath/Whirlpool Pillow

K-1601 Bath/Whirlpool Footstop

K-24916 Wireless Music Kit



ADA

Codes/Standards

CSA B45.5/IAPMO Z124

ASTM E162

ASTM E662

Greenguard UL 2818 - Gold

ADA

ICC/ANSI A117.1

KOHLER® One-Year Limited Warranty

See website for detailed warranty information.

Available Color/Finishes

Color tiles intended for reference only.

Color	Code	Description
	0	White
	96	Biscuit
	47	Almond
	NY	Dune
	95	Ice™ Grey
	G9	Sandbar
	33	Mexican Sand™
	K4	Cashmere
	58	Thunder™ Grey
	7	Black Black™

No change in measurement if connected with drain illustrated. (K-7272)

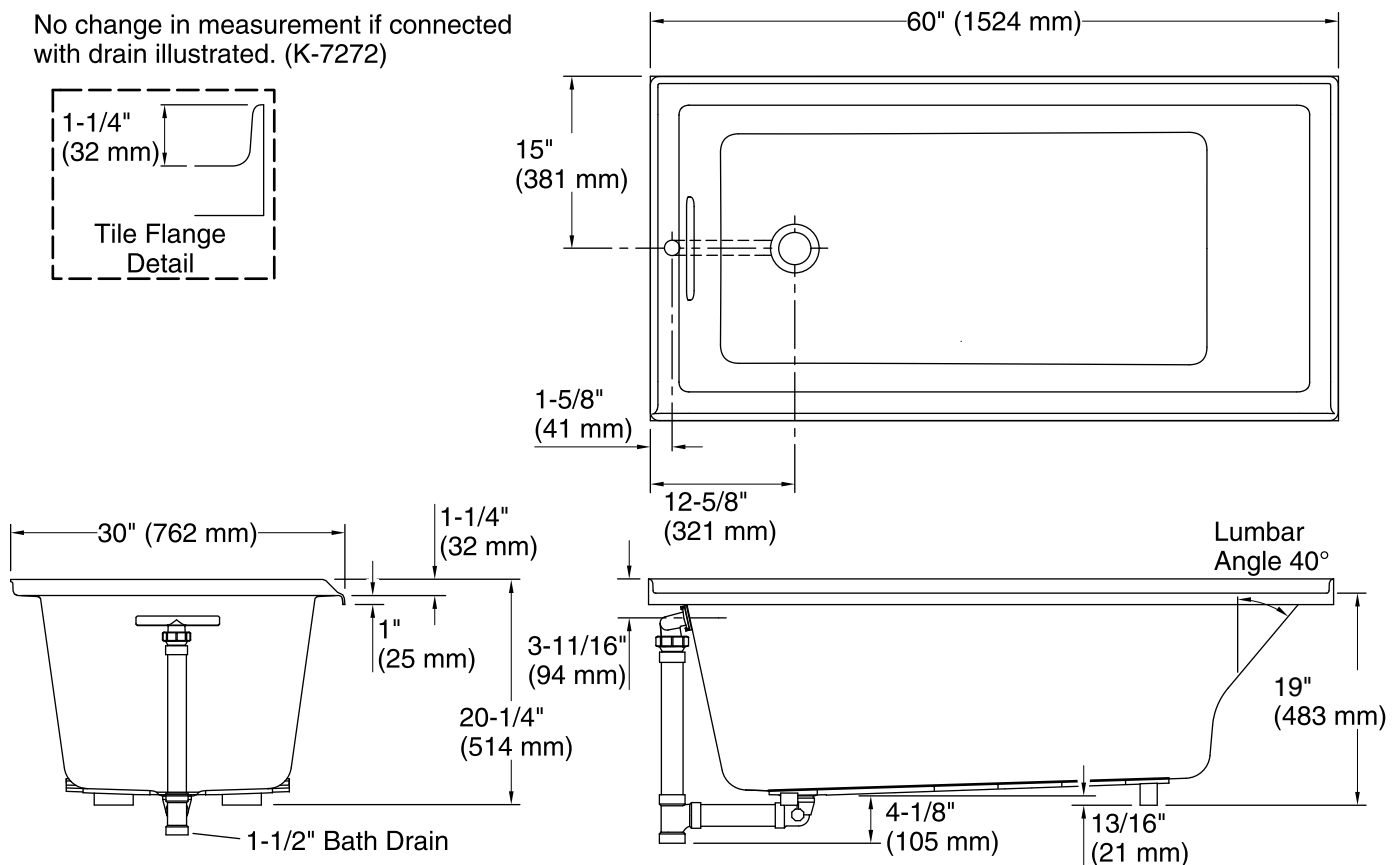
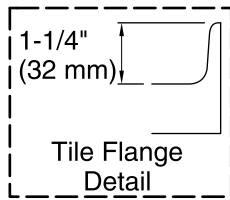

Technical Information

All product dimensions are nominal.

Installation:	3-Wall Alcove
Drain location:	Left
Basin area, bottom:	42-7/16" x 20" (1078 mm x 508 mm)
Basin area, top:	54-5/16" x 24-1/4" (1380 mm x 616 mm)
Weight:	75 lbs (34 kg)
Minimum floor load:	42 lbs/ft ² (205.1 kg/m ²)
Water depth:	15-1/8" (384 mm)
Water capacity:	59.8 gal (226.4 L)
Minimum flat for door:	1-15/16" (50 mm)

Notes

Measure your actual product for rough-in details.

Install this product according to the installation instructions.

The hot water supply should be 70% of the capacity of the bath or greater. Installations will vary.

ADA compliant when installed to the specific requirements of these regulations.