



Features

- End drain.
- Integral lumbar support and armrests for comfort.
- Textured bottom surface.
- 72" (1829 mm) x 42" (1067 mm) x 21" (533 mm)

Material

- Acrylic

Hydrotherapy

- Single-speed whirlpool offers six fully adjustable hydro-massage jets for water flow and direction.
- Pump with air switch for whirlpool.
- Multiple pump location options give you more choices for installation and access.

Installation

- Drop-in

Recommended Accessories

- K-11677 Bath Drain
- K-1491 Bath/Whirlpool Pillow
- K-1601 Bath/Whirlpool Footstop
- K-577 Undermount Install Kit
- K-24916 Wireless Music Kit
- K-7213 27" Cable Bath Drain
- K-7214 27" Cable Bath Drain
- K-7259 Clearflo Bath Drain
- K-9696 Whirlpool 6-Jet Trim Kit
- K-37382 45" Rough-in Cable Bath Drain



Codes/Standards



- ASME A112.19.7/CSA B45.10
- CSA B45.5/IAPMO Z124
- ASTM E162
- ASTM E662
- UL 1795
- Greenguard UL 2818 - Gold
- CARB P2

KOHLER® One-Year Limited Warranty

See website for detailed warranty information.

Available Color/Finishes

Color tiles intended for reference only.

Color	Code	Description
	0	White
	96	Biscuit
	47	Almond

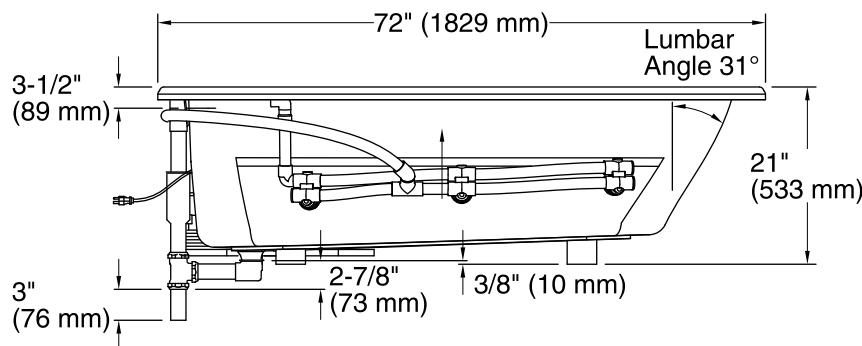
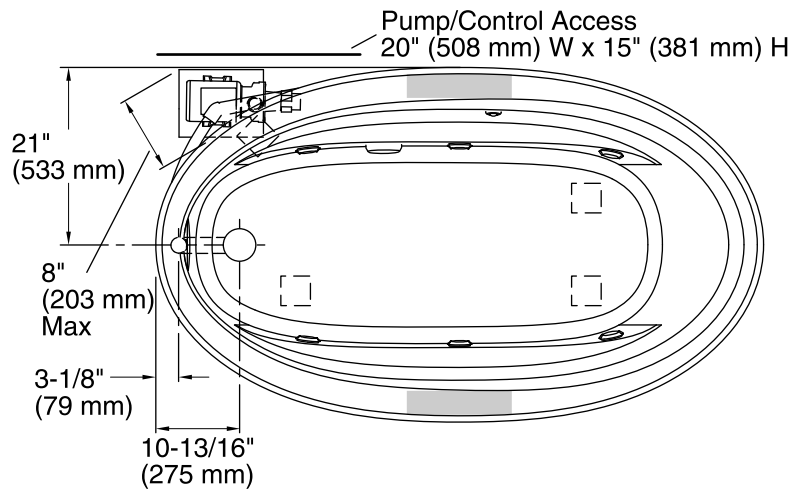

No change in measurements if connected with drain illustrated. (K-11677)

Recommended faucet area

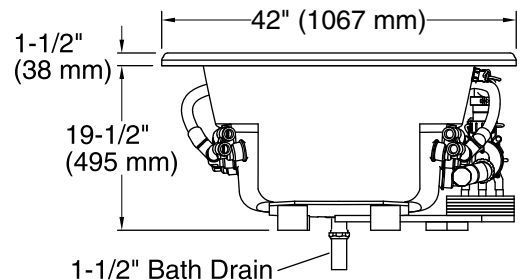
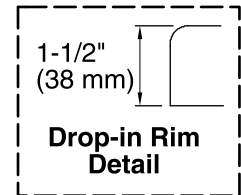

Required Electrical Service

One dedicated circuit required, protected with Class A Ground-Fault Circuit-Interrupter (GFCI) or Residual Current Device (RCD).

Pump: 120 V, 15 A, 60 Hz

Technical Information

All product dimensions are nominal.

Installation: Drop-in
 Drain location: End
 Basin area, bottom: 55-1/4" x 23-1/2" (1403 mm x 597 mm)
 Basin area, top: 64-1/2" x 32" (1638 mm x 813 mm)
 Weight: 112 lbs (50.8 kg)
 Minimum floor load: 36 lbs/ft² (175.8 kg/m²)
 Water depth: 15" (381 mm)
 Water capacity: 75 gal (283.9 L)
 Template: Drop-in, 1042557-7, required, included
 Electrical component rating: Pump: 120 V, 7.5 A, 60 Hz
 Pump speed: Single

Notes

Measure your actual product for rough-in details.

Install this product according to the installation instructions.

The hot water supply should be 70% of the capacity of the bath or greater. Installations will vary.

Provide one grounded electrical outlet within 24" (610 mm) of each component.