

Features

- Single-speed whirlpool offers performance and value, with 6 fully adjustable jets.
- Hydromassage flow and direction can be controlled at each jet.
- Oval-shaped basin creates a graceful and spacious bathing experience.
- Molded lumbar support and armrests offer extra comfort while bathing.
- Multiple pump location options give you more choices for installation and access. (See specification sheet for pump locations.)
- Reversible drain.

Material

- Acrylic

Hydrotherapy

- Whirlpool

Installation

- Drop-in

Recommended Products/Accessories

K-1491 Bath/Whirlpool Pillow
K-1601 Bath/Whirlpool Footstop
K-11677 Bath Drain
K-24916 Wireless Music Kit
K-7213 27" Cable Bath Drain
K-7214 27" Cable Bath Drain



Codes/Standards

ASME A112.19.7/CSA B45.10
CSA B45.5/IAPMO Z124
UL 1795



**KOHLER® Plastic Baths and Receptors
Lifetime Limited Warranty
KOHLER® Hydrotherapy Components
Five-Year Limited Warranty**

See website for detailed warranty information.

Available Colors/Finishes

Color tiles intended for reference only.

Color Code Description

	0	White
	96	Biscuit
	47	Almond

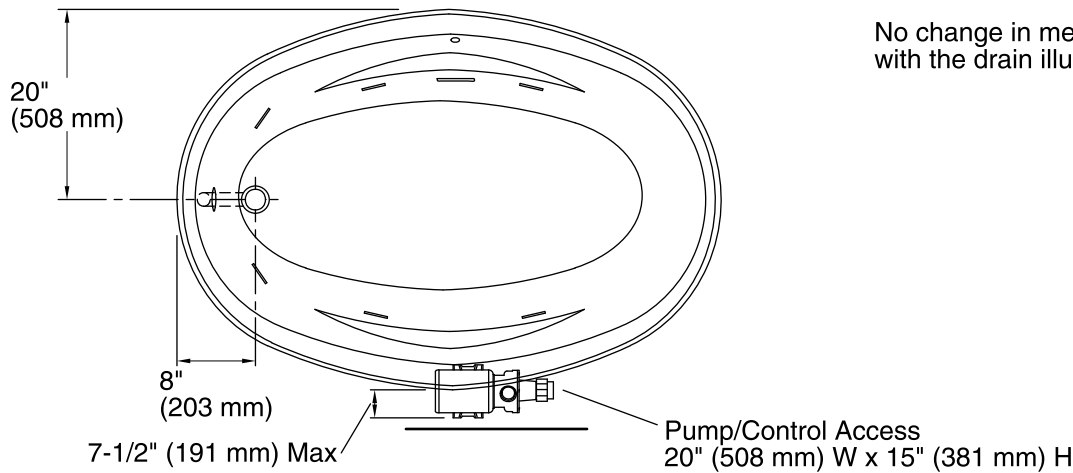

No change in measurements if connected with the drain illustrated. (K-11677)

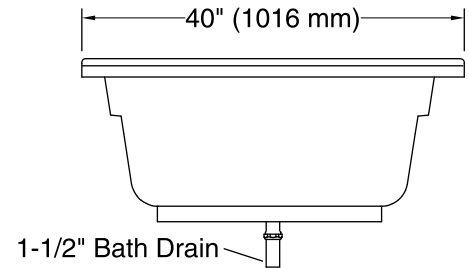
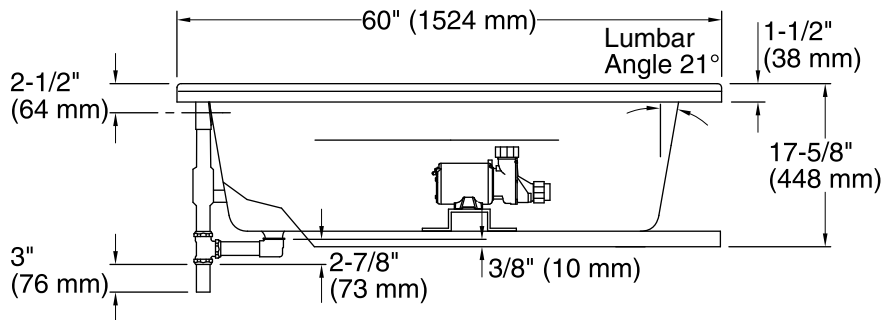
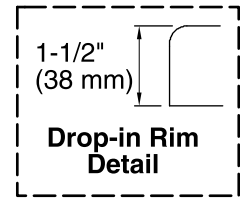

Required Electrical Service

One dedicated circuit required, protected with Class A Ground-Fault Circuit-Interrupter (GFCI). Outside North America, this device may be known as a Residual Current Device (RCD).

Pump: 120 V, 15 A, 60 Hz

Technical Information

All product dimensions are nominal.

Installation:	Drop-in
Drain location:	End
Basin area, bottom:	46" x 19" (1168 mm x 483 mm)
Basin area, top:	55" x 29" (1397 mm x 737 mm)
Weight:	56 lbs (25.4 kg)
Minimum floor load:	32 lbs/ft ² (156.2 kg/m ²)
Water depth:	14" (356 mm)
Water capacity:	54 gal (204.4 L)
Template:	Drop-in, 114859-7, required, included
Electrical component rating:	Pump: 120 V, 7.5 A, 60 Hz
Pump speed:	Single

Notes

Measure your actual product for rough-in details. Install this product according to the installation instructions.

The hot water supply should be 70% of the capacity of the bath or greater. Installations will vary.

Provide one grounded electrical outlet within 24" (610 mm) of each component.