

Features

- Vitreous china.
- One-piece.
- Comfort Height® Compact elongated bowl.
- AquaPiston® flushing system.
- Includes left-hand polished chrome trip lever.
- 1.28 gpf (4.8 lpf).
- 2-1/8" (54 mm) plastic trapway.
- 12" (305 mm) rough-in.
- Includes Glenbury™ Quiet-Close™ with Grip-Tight seat.
- Less supply.
- 9-5/8" (244 mm) x 7-3/8" (187 mm) water area.
- 27-3/4" (705 mm) x 18-1/4" (464 mm) x 28-1/4" (718 mm).
- Floor mount/Floor outlet.

Optional Accessories

- K-5383 10" Rough-in Full Skirt Trap and Attachment System
- K-5381 14" Rough-in Full Skirt Trap and Attachment System
- K-7637 Angle Supply with Stop (single)



ADA **CSA B651** **OBC**











Codes/Standards

ASME A112.19.2/CSA B45.1
DOE - Energy Policy Act 1992
EPA WaterSense®
California Energy Commission (CEC)
ADA
ICC/ANSI A117.1
CSA B651
OBC

See website for detailed warranty information.

Available Color/Finishes

Color tiles intended for reference only.

| Color | Code | Description |
|--|------|---------------|
|  | 0 | |
|  | 96 | |
|  | 47 | Almond |
|  | NY | |
|  | 95 | |
|  | G9 | |
|  | 33 | Mexican Sand™ |
|  | K4 | |
|  | 58 | |
|  | 7 | |

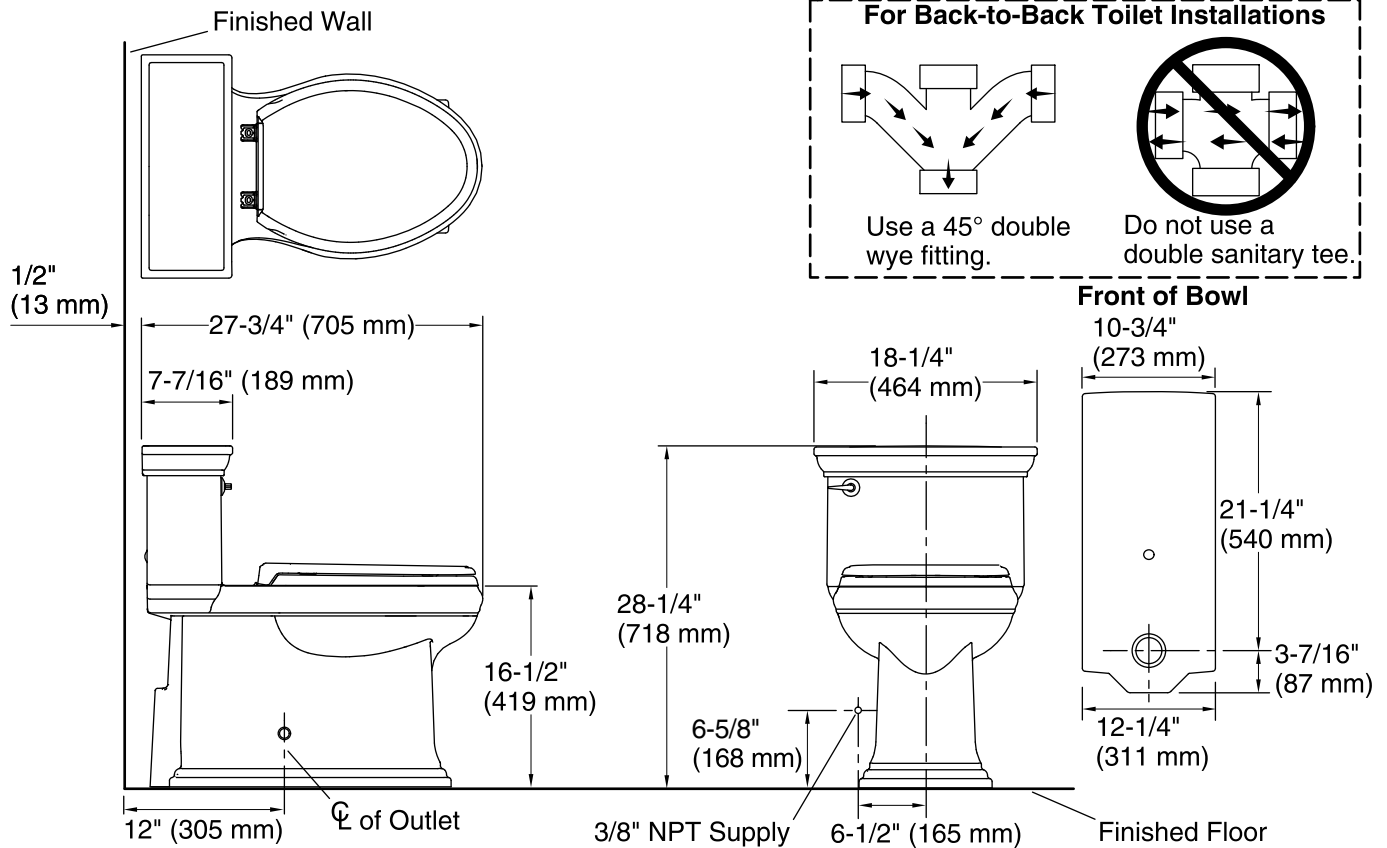

Technical Information

All product dimensions are nominal.

| | |
|-----------------------|-----------------------------------|
| Toilet type: | One-piece |
| Bowl shape: | Compact Elongated front |
| Flush type: | AquaPiston |
| Trap passageway: | 2-1/8" (54 mm) |
| Water Consumption | |
| Full: | 1.28 gpf (4.8 lpf) |
| Water surface size: | 9-5/8" x 7-3/8" (244 mm x 187 mm) |
| Rim to water surface: | 5-3/8" (137 mm) |
| Rough-in: | 12" (305 mm) |
| Seat-mounting holes: | 5-1/2" (140 mm) |

Notes

Install this product according to the installation instructions.

For back-to-back toilet installations: Use only a 45° double wye fitting.

ADA, OBC, CSA B651 compliant when installed to the specific requirements of these regulations.

Plumbing Codes require elongated toilets and elongated, open-front toilet seats in public bathrooms.

Accessibility standards require controls to be located on the open side of the toilet.

Features

- Elongated seat with Cleansing Functionality.
- Touchscreen Remote Control (includes 2 programmable user presets)
- Continuously heated water with adjustable temperature settings
- Heated seat with adjustable temperature settings
- Quick-Release™ design for ease of cleaning
- Quiet-Close™ functionality to prevent seat from slamming
- Automatic deodorization function for odor control
- Automatic nightlight function to illuminate the bowl
- Energy save function
- Anti-microbial materials used in seat and nozzle
- Air blower function allowing selection of air speed and temperature
- Single stainless steel wand with adjustable water pressure, temperature, and pulsate settings

Components

Additional included component/s: Remote, and Supply hose.



Codes/Standards

ASME A112.4.2
UL 1431
CSA C22.2 No. 64
CSA C22.2 No. 68

KOHLER Intelligent Toilet and C3 Cleansing Seat Three-Year Limited Warranty



KOHLER Intelligent Toilet and C3 Cleansing Seat Three-Year Limited Warranty

See website for detailed warranty information.

Available Color/Finishes

Color tiles intended for reference only.

| Color | Code | Description |
|-------|------|-------------|
|-------|------|-------------|

| | | |
|--|----|---------|
|  | 0 | White |
|  | 96 | Biscuit |

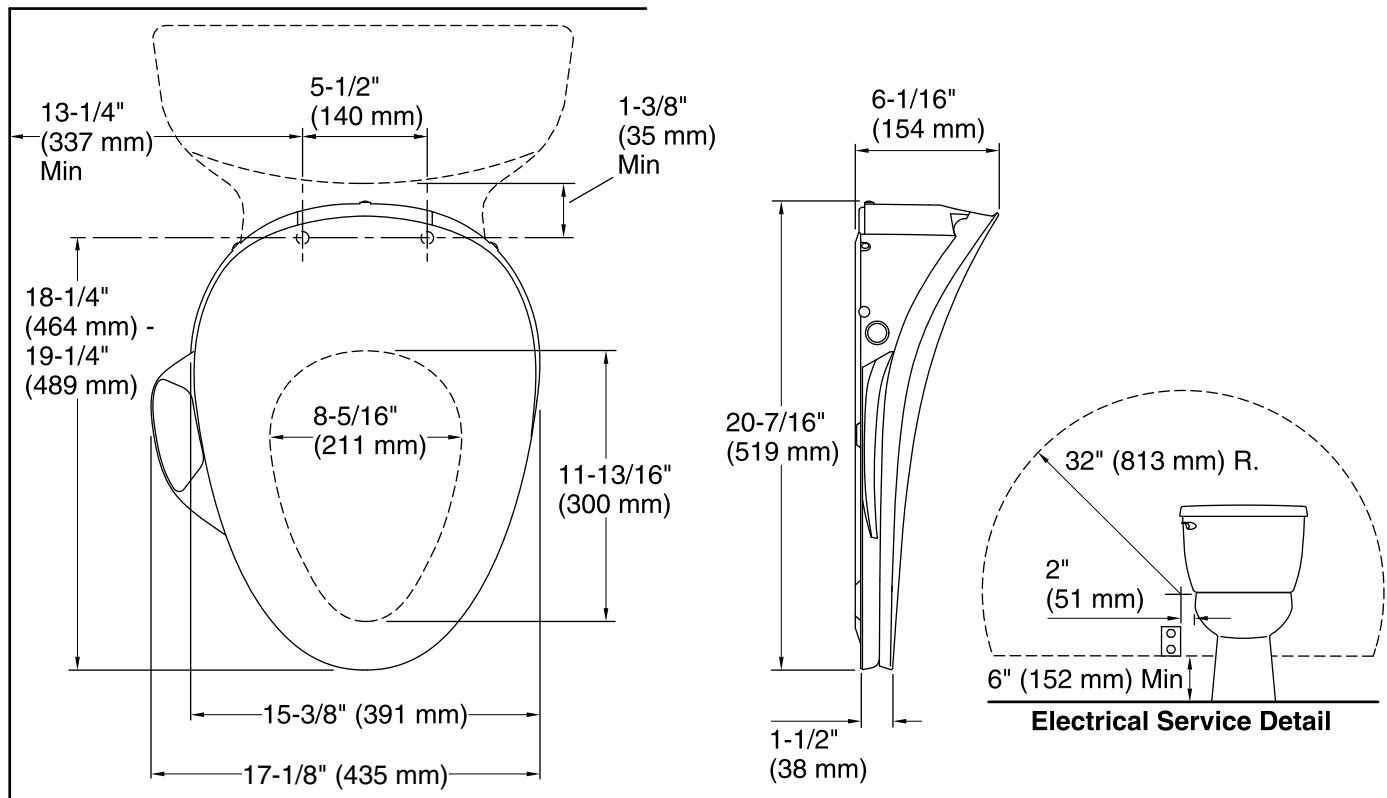

Required Electrical Service

One dedicated circuit required, protected with Class A Ground-Fault Circuit-Interrupter (GFCI) or Residual Current Device (RCD).

120 V, 15 A, 60 Hz

Technical Information

All product dimensions are nominal.

Seat shape type: Elongated
 Seat front type: Closed front
 Seat hinge type: Quiet-Close™
 Seat-mounting holes: 5-1/2" (139 mm)
 Power cord length: 46" (1168 mm)

Notes

Install this product according to the installation guide.

Connect the seat to a cold water supply of drinking quality water at a pressure of 20 psi - 80 psi (139 kPa - 551 kPa).

Do not install this seat in a location where: (1) water might be splashed on the product or (2) excessive moisture, high humidity levels, or condensation is present. This will avoid damage to the electronic components.

Do not use an extension cord with this product.

To avoid possible product malfunction, do not plug in the seat until instructed to do so.

Locate the receptacle at least 6" (152 mm) above the floor, and within a 32" (813 mm) radius measured 2" (51 mm) from the bowl ledge.