

Features

- Vitreous china
- Comfort Height® Compact elongated bowl
- AquaPiston® flushing system
- Includes left-hand polished chrome trip lever
- 1.28 gpf (4.8 lpf)
- Fully Skirted 2 1/8" (54 mm) plastic trapway
- 12" (305 mm) rough-in
- Patented ReadyLock™ installation system
- Includes Glenbury™ Q3 seat, cover [K-4733]
- 9-5/8" (245 mm) x 6-7/8" (174 mm) water area
- 28-1/2" (724 mm) x 17-5/16" (440 mm) x 28-1/4" (718 mm)
- Floor Mount / Floor Outlet

Recommended Accessories

- K-75796 Cachet® Nightlight Quiet-Close™ Elongated Toilet Seat
- K-4108 C3®-230 Elongated Cleansing Toilet Seat
- K-5381 14" Rough-in Full Skirt Trap and Attachment System
- K-5383 10" Rough-in Full Skirt Trap and Attachment System
- K-9375 Trip Lever

Components

Additional included component/s: Tank Cover, Trip Lever, and ReadyLock™ installation system.



ADA **CSA B651** **OBC**

Codes/Standards











ASME A112.19.2/CSA B45.1
DOE - Energy Policy Act 1992
EPA WaterSense®
California Energy Commission (CEC)
ADA
ICC/ANSI A117.1
CSA B651
OBC

KOHLER® One-Year Limited Warranty

See website for detailed warranty information.

Available Color/Finishes

Color tiles intended for reference only.

Color	Code	Description
	0	White
	96	Biscuit
	47	Almond
	NY	Dune
	95	Ice™ Grey
	G9	Sandbar
	33	Mexican Sand™
	K4	Cashmere
	58	Thunder™ Grey
	7	Black Black™

Features

- Hybrid heater provides continuously heated water for consistent comfort.
- Heated seat with five temperature settings.
- Stainless steel wand with automatic UV-light self-sanitization.
- LED lighting illuminates the bowl to serve as a night-light.
- Sleek, handheld remote control with two programmable user presets.
- Front and Rear Wash modes provide warm water for cleansing.
- Adjustable water temperature and water pressure.
- Choose oscillating or pulsating spray.
- Warm-air drying system with adjustable air speed and temperature.
- Automatic deodorization with carbon filter for odor control.
- Quiet-Close™ lid closes slowly and quietly without slamming.
- Quick-Release™ hinges allow seat to be unlatched from toilet for easy removal and convenient cleaning; no tools required.
- Grip-Tight bumpers add stability and prevent shifting.
- Ergonomically designed for comfortable seating.

Material

- Plastic

Installation

- Requires connection to toilet water supply line. All hoses and connections are included.
- Requires Phillips screwdriver and adjustable wrench for installation.
- Dedicated electrical GFCI circuit required (120V, 15A, 60Hz, 1800W).
- Fits most elongated toilets.

Components

Additional included component/s: T-fitting, Inlet water supply hose, and Seat mounting bracket.



Codes/Standards

ASME A112.4.2/CSA B45.16
UL 1431
CSA C22.2 No. 64
CSA C22.2 No. 68

KOHLER® Intelligent Toilet and C3® Cleansing Seat Three-Year Limited Warranty

See website for detailed warranty information.

Available Color/Finishes

Color tiles intended for reference only.

Color	Code	Description
-------	------	-------------

	0	White
--	---	-------

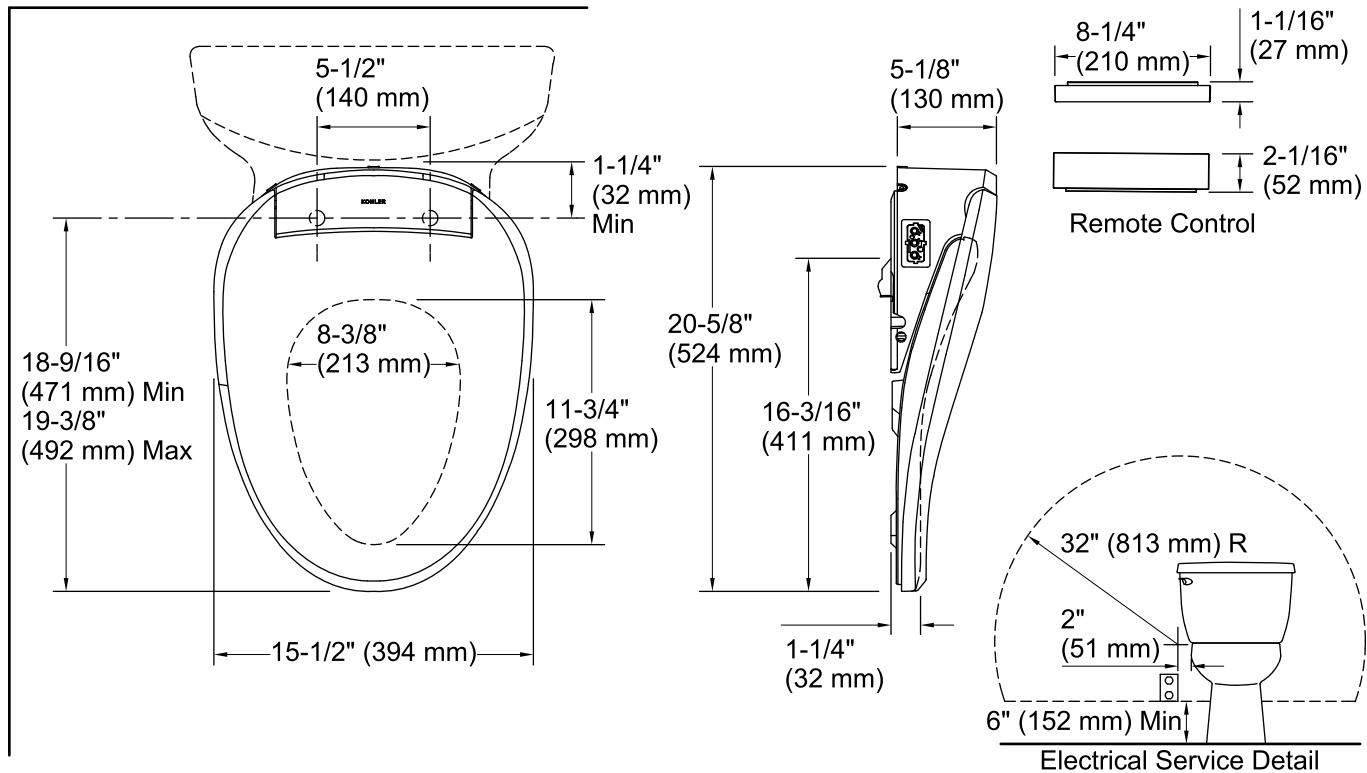

Required Electrical Service

One circuit required, protected with Class A Ground-Fault Circuit-Interrupter (GFCI) or Residual Current Device (RCD).

120 V, 15 A, 60 Hz

Technical Information

All product dimensions are nominal.

Seat shape type: Elongated
 Seat front type: Closed-front
 Seat-mounting holes: 5-1/2" (140 mm)
 Power cord length: 43" (1092 mm)

Notes

Install this product according to the installation instructions.

Connect the seat to a cold water supply of drinking quality water at a pressure of 20 psi - 80 psi (139 kPa - 551 kPa).

Do not install this seat in a location where: (1) water might be splashed on the product or (2) excessive moisture, high humidity levels, or condensation is present. This will avoid damage to the electronic components.

Do not use an extension cord with this product.

To avoid possible product malfunction, do not plug in the seat until instructed to do so.

Locate the receptacle at least 6" (152 mm) above the floor, and within a 32" (813 mm) radius measured 2" (51 mm) from the bowl ledge.