

Features

- One-piece toilets integrate the tank and bowl into a seamless, easy-to-clean design.
- Elongated bowl offers added room and comfort.
- Comfort Height® feature offers chair-height seating that makes sitting down and standing up easier for most adults.
- 1.28 gallons per flush (gpf).
- Concealed trapway facilitates easy cleaning and enhances design.
- Standard left-hand Polished Chrome trip lever included.
- Grip-Tight Glenbury Quiet-Close™ seat with Quick-Release™ functionality allows seat to close quietly and quickly unlatch from the toilet for easy removal and convenient cleaning.
- Supply line not included.
- Coordinates with other products in the Kathryn collection.

Technology

- Single-flush gravity uses the force of gravity and a precision-engineered tank to create a strong siphon during flushing.
- AquaPiston canister allows water to flow into the bowl from all sides (360 degrees), increasing the power and effectiveness of the flush.
- Flush valve's 3:2 ratio harnesses the natural force of gravity and optimizes flush performance.
- Durable canister design has 90% less exposed seal material than a 3-inch flapper, for leak-free performance.
- Light-touch canister flush requires a lower actuation force than a flapper.

Installation

- Standard 12-inch rough-in.

Water Conservation & Rebates

- WaterSense® toilets meet strict EPA flushing guidelines, including using at least 20 percent less water than 1.6-gallon toilets.
- Eligible for consumer rebates in some municipalities.

Recommended Accessories

K-7637 Angle Supply with Stop (single)

Optional Accessories

K-9131 Trip Lever
K-4650 Toilet Seat

Components

Product includes:

K-4733 Toilet Seat

Additional included component/s: Tank cover, trip lever, tank accessory pack, and bolt cap accessory pack.



ADA CSA B651 OBC

Codes/Standards











ASME A112.19.2/CSA B45.1
EPA WaterSense®
ADA
ICC/ANSI A117.1
CSA B651
OBC

Kohler One-Year Limited Warranty

See website for detailed warranty information.

Available Color/Finishes

Color tiles intended for reference only.

Color	Code	Description
	0	White
	96	Biscuit
	47	Almond
	NY	Dune
	95	Ice™ Grey
	G9	Sandbar
	33	Mexican Sand™
	K4	Cashmere
	58	Thunder™ Grey
	7	Black Black™

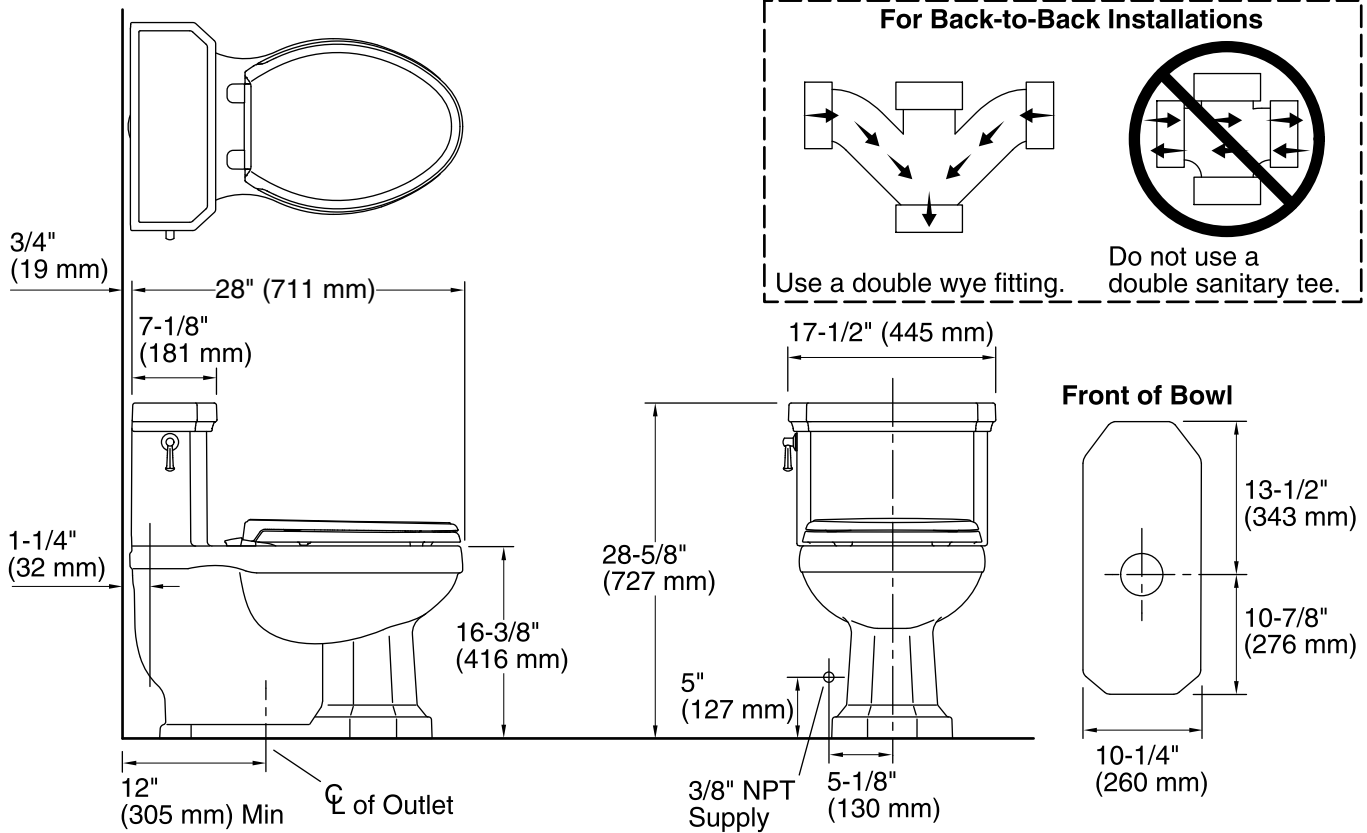

Technical Information

All product dimensions are nominal.

Toilet type:	One-piece
Bowl shape:	Elongated front
Trap passageway:	2-1/8" (54 mm)
Water Consumption	
Full:	1.28 gpf (4.8 lpf)
Water surface size:	10-1/2" x 7-1/2" (267 mm x 191 mm)
Rim to water surface:	5-5/8" (143 mm)
Rough-in:	12" (305 mm)
Seat-mounting holes:	5-1/2" (140 mm)

Notes

Install this product according to the installation instructions.

For back-to-back toilet installations: Use only a 45 degree double wye fitting.

ADA, OBC, CSA B651 compliant when installed to the specific requirements of these regulations.

Plumbing Codes require elongated toilets and elongated, open-front toilet seats in public bathrooms.

Accessibility standards require controls to be located on the open side of the toilet.

Features

- Elongated seat with Cleansing Functionality.
- Touchscreen Remote Control (includes 2 programmable user presets)
- Continuously heated water with adjustable temperature settings
- Heated seat with adjustable temperature settings
- Quick-Release™ design for ease of cleaning
- Quiet-Close™ functionality to prevent seat from slamming
- Automatic deodorization function for odor control
- Automatic nightlight function to illuminate the bowl
- Energy save function
- Anti-microbial materials used in seat and nozzle
- Air blower function allowing selection of air speed and temperature
- Single stainless steel wand with adjustable water pressure, temperature, and pulsate settings

Components

Additional included component/s: Remote, and Supply hose.



Codes/Standards

ASME A112.4.2
UL 1431
CSA C22.2 No. 64
CSA C22.2 No. 68

KOHLER Intelligent Toilet and C3 Cleansing Seat Three-Year Limited Warranty



KOHLER Intelligent Toilet and C3 Cleansing Seat Three-Year Limited Warranty

See website for detailed warranty information.

Available Color/Finishes

Color tiles intended for reference only.

Color	Code	Description
-------	------	-------------

	0	White
	96	Biscuit

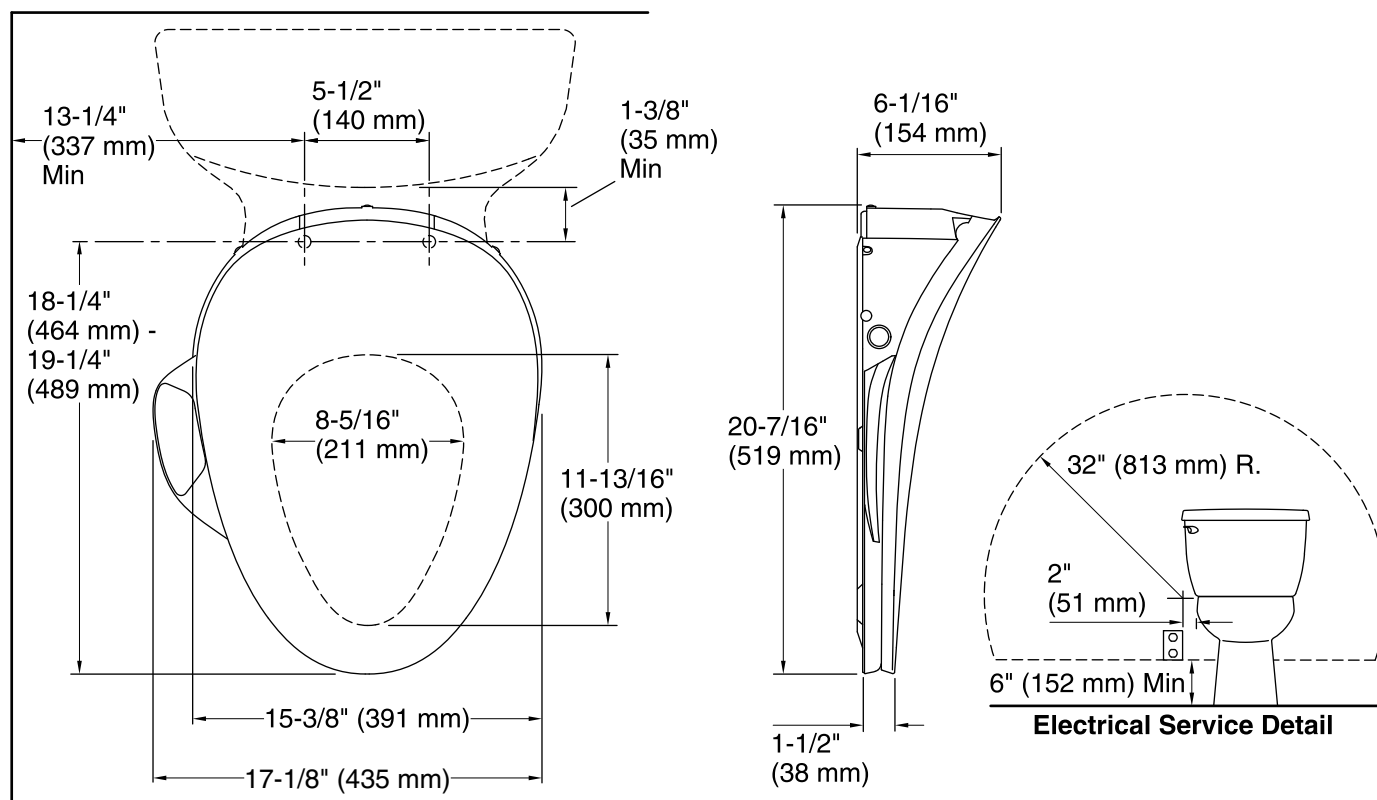

Required Electrical Service

One dedicated circuit required, protected with Class A Ground-Fault Circuit-Interrupter (GFCI) or Residual Current Device (RCD).

120 V, 15 A, 60 Hz

Technical Information

All product dimensions are nominal.

Seat shape type: Elongated
 Seat front type: Closed front
 Seat hinge type: Quiet-Close™
 Seat-mounting holes: 5-1/2" (139 mm)
 Power cord length: 46" (1168 mm)

Notes

Install this product according to the installation guide.

Connect the seat to a cold water supply of drinking quality water at a pressure of 20 psi - 80 psi (139 kPa - 551 kPa).

Do not install this seat in a location where: (1) water might be splashed on the product or (2) excessive moisture, high humidity levels, or condensation is present. This will avoid damage to the electronic components.

Do not use an extension cord with this product.

To avoid possible product malfunction, do not plug in the seat until instructed to do so.

Locate the receptacle at least 6" (152 mm) above the floor, and within a 32" (813 mm) radius measured 2" (51 mm) from the bowl ledge.