



Memoirs® Stately

Toilet tank, 1.28 gpf
K-4434

Features

- Left-hand Polished Chrome trip lever
- Combines with the K-4387 bowl to create a complete K-3933 Memoirs toilet
- Coordinates with other products in the Memoirs collection
- Class Five® canister optimizes the flow out of the tank, harnessing gravity and the natural powerful reducing cascade of water to increase the power and effectiveness of the flush
- 1.28 gpf (4.8 lpf)

Installation

- Supply line sold separately

Recommended Products/Accessories

K-4387 Round-front toilet bowl
K-23726 Drain treatment



Codes/Standards

ASME A112.19.2/CSA B45.1
EPA WaterSense®
IAPMO Certification

KOHLER® Toilets and Seats Limited Warranty

See website for detailed warranty information.

Available Colors/Finishes

Color tiles intended for reference only.

| Color | Code | Description |
|-------|------|--------------|
| | 0 | White |
| | 96 | Biscuit |
| | NY | Dune |
| | 95 | Ice™ Grey |
| | 7 | Black Black™ |
| | 17 | Teal |
| | 42 | Aspen Green |
| | H15 | Spring Green |
| | V10 | Peachblow |

1-800-4KOHLER (1-800-456-4537)

Kohler Co. reserves the right to make revisions without notice to product specifications.

For the most current Specification Sheet, go to www.kohler.com USA or www.kohler.ca Canada

2-22-2024 10:29 - US

THE BOLD LOOK
OF **KOHLER**®



Memoirs® Stately
Toilet tank, 1.28 gpf
K-4434

No image available.
This product is a component and not intended to be a standalone installation.

Technical Information

All product dimensions are nominal.

Toilet type: Bowl-mount

Flush type: Class Five

Notes

Install this product according to the installation instructions.

Features

- Vitreous china
- Comfort Height Elongated bowl
- 2-1/8" (54 mm) fully glazed trapway
- 12" (305 mm) rough-in
- Combines with the K-4433 or K-4434 tank to create a complete K-3816 or K-3817 toilet



Codes/Standards







ASME A112.19.2/CSA B45.1

KOHLER® One-Year Limited Warranty

See website for detailed warranty information.

Available Color/Finishes

Color tiles intended for reference only.

| Color | Code | Description |
|--|------|--------------|
|  | 0 | White |
|  | 96 | Biscuit |
|  | 47 | Almond |
|  | NY | Dune |
|  | 95 | Ice™ Grey |
|  | G9 | Sandbar |
|  | 7 | Black Black™ |

No image available.

This product is a component and not intended to be a standalone installation.

Technical Information

All product dimensions are nominal.

Toilet type: Two-piece, Floor-mount

Waste Outlet: Floor

Bowl shape: Elongated front

Flush type: AquaPiston

Trap passageway: 2-1/8" (54 mm)

Rough-in: 12" (305 mm)

Seat-mounting holes: 5-1/2" (140 mm)

Notes

Install this product according to the installation instructions.

Features

- Hybrid heater provides continuously heated water for consistent comfort.
- Heated seat with five temperature settings.
- Stainless steel wand with automatic UV-light self-sanitization.
- LED lighting illuminates the bowl to serve as a night-light.
- Sleek, handheld remote control with two programmable user presets.
- Front and Rear Wash modes provide warm water for cleansing.
- Adjustable water temperature and water pressure.
- Choose oscillating or pulsating spray.
- Warm-air drying system with adjustable air speed and temperature.
- Automatic deodorization with carbon filter for odor control.
- Quiet-Close™ lid closes slowly and quietly without slamming.
- Quick-Release™ hinges allow seat to be unlatched from toilet for easy removal and convenient cleaning; no tools required.
- Grip-Tight bumpers add stability and prevent shifting.
- Ergonomically designed for comfortable seating.

Material

- Plastic

Installation

- Requires connection to toilet water supply line. All hoses and connections are included.
- Requires Phillips screwdriver and adjustable wrench for installation.
- Dedicated electrical GFCI circuit required (120V, 15A, 60Hz, 1800W).
- Fits most elongated toilets.

Components

Additional included component/s: T-fitting, Inlet water supply hose, and Seat mounting bracket.



Codes/Standards

ASME A112.4.2/CSA B45.16
UL 1431
CSA C22.2 No. 64
CSA C22.2 No. 68

KOHLER® Intelligent Toilet and C3® Cleansing Seat Three-Year Limited Warranty

See website for detailed warranty information.

Available Color/Finishes

Color tiles intended for reference only.

| Color | Code | Description |
|-------|------|-------------|
|-------|------|-------------|

| | | |
|--|---|-------|
|  | 0 | White |
|--|---|-------|

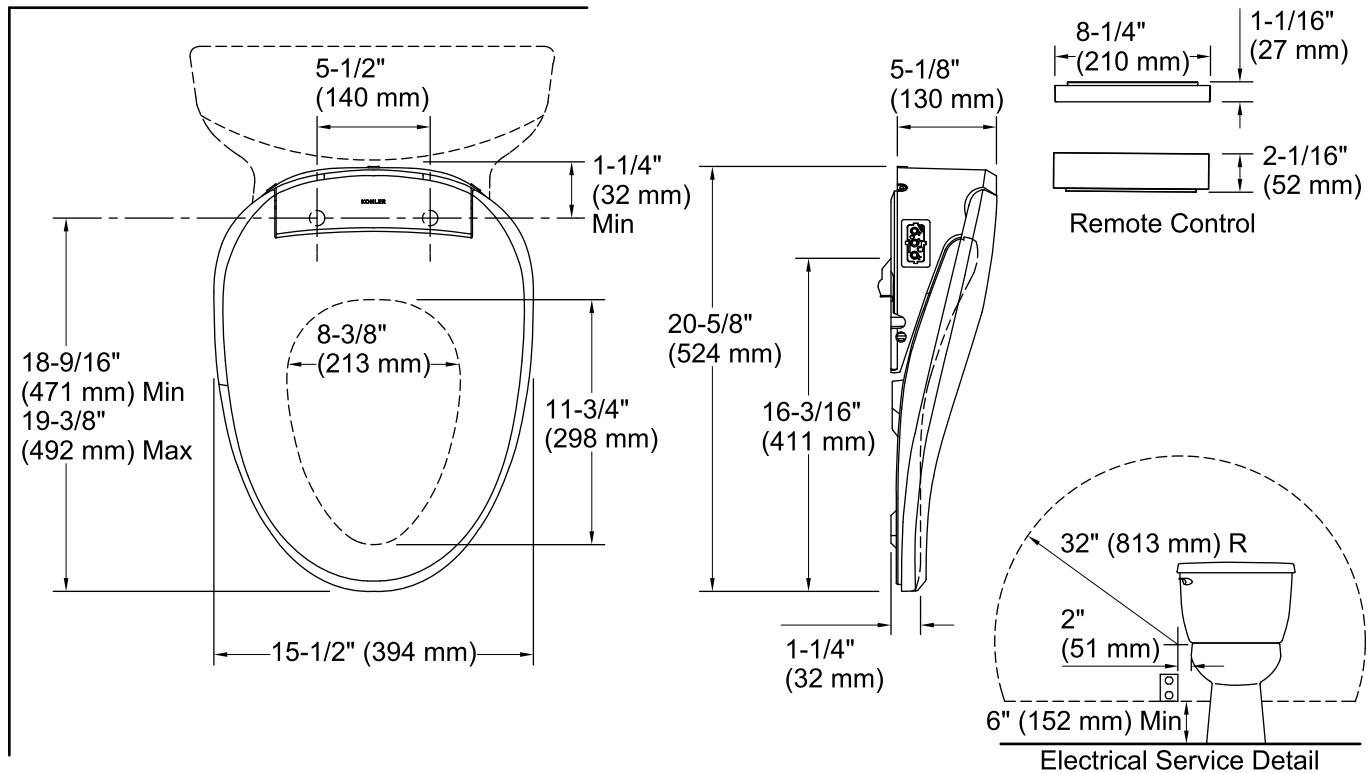

Required Electrical Service

One circuit required, protected with Class A Ground-Fault Circuit-Interrupter (GFCI) or Residual Current Device (RCD).

120 V, 15 A, 60 Hz

Technical Information

All product dimensions are nominal.

Seat shape type: Elongated
 Seat front type: Closed-front
 Seat-mounting holes: 5-1/2" (140 mm)
 Power cord length: 43" (1092 mm)

Notes

Install this product according to the installation instructions.

Connect the seat to a cold water supply of drinking quality water at a pressure of 20 psi - 80 psi (139 kPa - 551 kPa).

Do not install this seat in a location where: (1) water might be splashed on the product or (2) excessive moisture, high humidity levels, or condensation is present. This will avoid damage to the electronic components.

Do not use an extension cord with this product.

To avoid possible product malfunction, do not plug in the seat until instructed to do so.

Locate the receptacle at least 6" (152 mm) above the floor, and within a 32" (813 mm) radius measured 2" (51 mm) from the bowl ledge.