



Memoirs® Stately

Toilet tank, 1.28 gpf
K-4434

Features

- Left-hand Polished Chrome trip lever
- Combines with the K-4387 bowl to create a complete K-3933 Memoirs toilet
- Coordinates with other products in the Memoirs collection
- Class Five® canister optimizes the flow out of the tank, harnessing gravity and the natural powerful reducing cascade of water to increase the power and effectiveness of the flush
- 1.28 gpf (4.8 lpf)

Installation

- Supply line sold separately

Recommended Products/Accessories

K-4387 Round-front toilet bowl
K-23726 Drain treatment



Codes/Standards

ASME A112.19.2/CSA B45.1
EPA WaterSense®
IAPMO Certification

KOHLER® Toilets and Seats Limited Warranty

See website for detailed warranty information.

Available Colors/Finishes

Color tiles intended for reference only.

Color	Code	Description
	0	White
	96	Biscuit
	NY	Dune
	95	Ice™ Grey
	7	Black Black™
	17	Teal
	42	Aspen Green
	H15	Spring Green
	V10	Peachblow

1-800-4KOHLER (1-800-456-4537)

Kohler Co. reserves the right to make revisions without notice to product specifications.

For the most current Specification Sheet, go to www.kohler.com USA or www.kohler.ca Canada

2-22-2024 10:29 - US

THE BOLD LOOK
OF **KOHLER**®



Memoirs® Stately
Toilet tank, 1.28 gpf
K-4434

No image available.
This product is a component and not intended to be a standalone installation.

Technical Information

All product dimensions are nominal.

Toilet type: Bowl-mount

Flush type: Class Five

Notes

Install this product according to the installation instructions.

Features

- Vitreous china
- Comfort Height Elongated bowl
- 2-1/8" (54 mm) fully glazed trapway
- 12" (305 mm) rough-in
- Combines with the K-4433 or K-4434 tank to create a complete K-3816 or K-3817 toilet



Codes/Standards







ASME A112.19.2/CSA B45.1

KOHLER® One-Year Limited Warranty

See website for detailed warranty information.

Available Color/Finishes

Color tiles intended for reference only.

Color	Code	Description
	0	White
	96	Biscuit
	47	Almond
	NY	Dune
	95	Ice™ Grey
	G9	Sandbar
	7	Black Black™

No image available.

This product is a component and not intended to be a standalone installation.

Technical Information

All product dimensions are nominal.

Toilet type:	Two-piece, Floor-mount
Waste Outlet:	Floor
Bowl shape:	Elongated front
Flush type:	AquaPiston
Trap passageway:	2-1/8" (54 mm)
Rough-in:	12" (305 mm)
Seat-mounting holes:	5-1/2" (140 mm)

Notes

Install this product according to the installation instructions.

Features

- Elongated seat with Cleansing Functionality.
- Touchscreen Remote Control (includes 2 programmable user presets)
- Continuously heated water with adjustable temperature settings
- Heated seat with adjustable temperature settings
- Quick-Release™ design for ease of cleaning
- Quiet-Close™ functionality to prevent seat from slamming
- Automatic deodorization function for odor control
- Automatic nightlight function to illuminate the bowl
- Energy save function
- Anti-microbial materials used in seat and nozzle
- Air blower function allowing selection of air speed and temperature
- Single stainless steel wand with adjustable water pressure, temperature, and pulsate settings

Components

Additional included component/s: Remote, and Supply hose.



Codes/Standards

ASME A112.4.2
UL 1431
CSA C22.2 No. 64
CSA C22.2 No. 68

KOHLER Intelligent Toilet and C3 Cleansing Seat Three-Year Limited Warranty



KOHLER Intelligent Toilet and C3 Cleansing Seat Three-Year Limited Warranty

See website for detailed warranty information.

Available Color/Finishes

Color tiles intended for reference only.

Color	Code	Description
-------	------	-------------

	0	White
	96	Biscuit

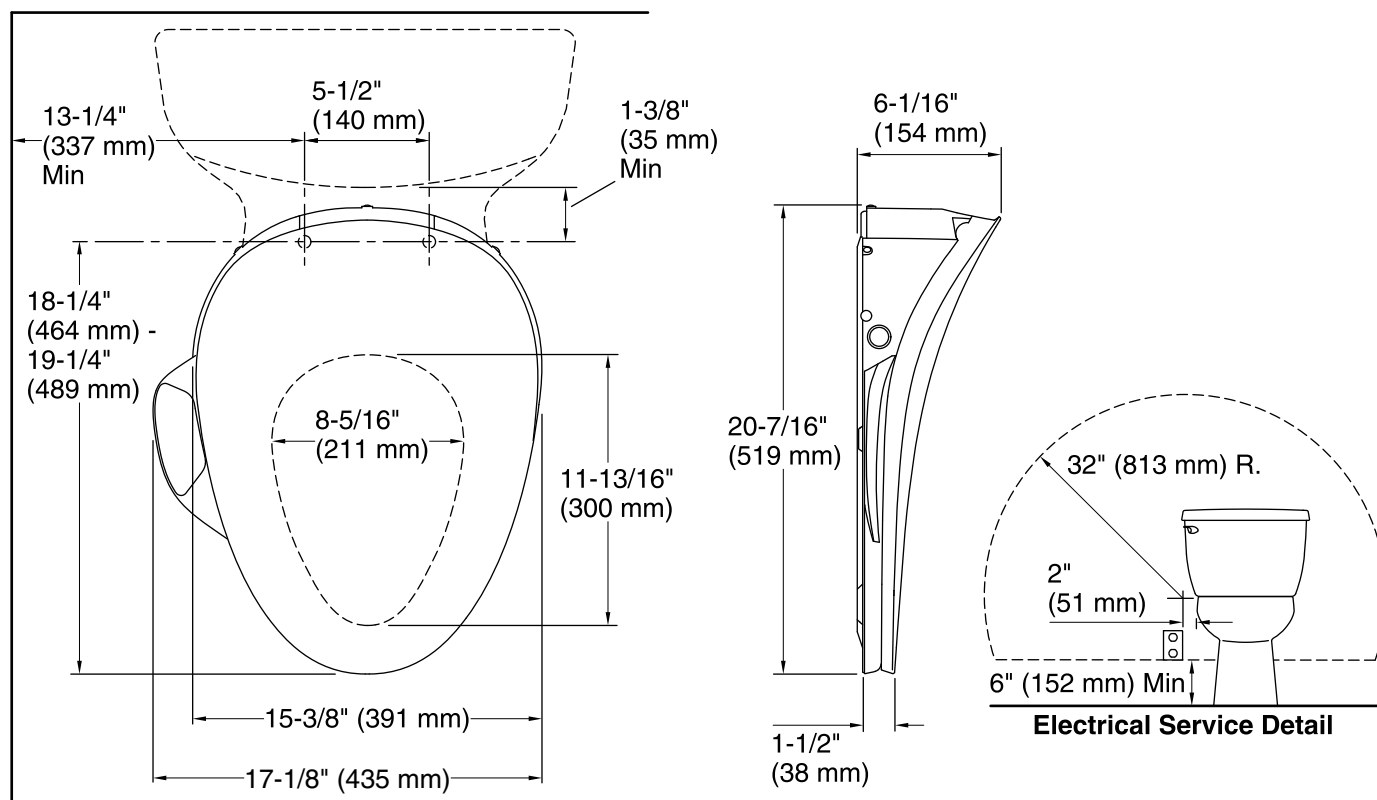

Required Electrical Service

One dedicated circuit required, protected with Class A Ground-Fault Circuit-Interrupter (GFCI) or Residual Current Device (RCD).

120 V, 15 A, 60 Hz

Technical Information

All product dimensions are nominal.

Seat shape type: Elongated
 Seat front type: Closed front
 Seat hinge type: Quiet-Close™
 Seat-mounting holes: 5-1/2" (139 mm)
 Power cord length: 46" (1168 mm)

Notes

Install this product according to the installation guide.

Connect the seat to a cold water supply of drinking quality water at a pressure of 20 psi - 80 psi (139 kPa - 551 kPa).

Do not install this seat in a location where: (1) water might be splashed on the product or (2) excessive moisture, high humidity levels, or condensation is present. This will avoid damage to the electronic components.

Do not use an extension cord with this product.

To avoid possible product malfunction, do not plug in the seat until instructed to do so.

Locate the receptacle at least 6" (152 mm) above the floor, and within a 32" (813 mm) radius measured 2" (51 mm) from the bowl ledge.