

Features

- Vitreous china
- Class Five® flushing system
- Includes left-hand polished chrome trip lever
- 1.28 gpf (4.8 lpf)
- Less supply line
- Combines with the K-4199 bowl to create a complete K-3999 Highline toilet
- Coordinates with other products in the Wellworth collection

Technology

- Single-flush gravity uses the force of gravity and a precision-engineered tank to create a strong siphon during flushing
- Canister flush valve optimizes flush performance and resists warping and deterioration
- Class Five® flushing technology offers plug- and leak-free performance, extraordinary flushing, and better rinsing power for a cleaner bowl

Water Conservation & Rebates

- WaterSense® toilets meet strict EPA flushing guidelines, including using at least 20 percent less water than 1.6-gallon toilets
- Eligible for consumer rebates in some municipalities

Optional Accessories

K-1954 Touchless Toilet Flush Kit



Codes/Standards





ASME A112.19.2/CSA B45.1

KOHLER® One-Year Limited Warranty

See website for detailed warranty information.

Available Color/Finishes

Color tiles intended for reference only.

| Color | Code | Description |
|--|------|--------------|
|  | 0 | White |
|  | 96 | Biscuit |
|  | 47 | Almond |
|  | 7 | Black Black™ |

No image available.

This product is a component and not intended to be a standalone installation.

Technical Information

All product dimensions are nominal.

Toilet type: Two-piece

Notes

Install this product according to the installation instructions.



Highline® Tall

Elongated tall toilet bowl
K-22661

Features

- Elongated bowl offers added room and comfort.
- Highline® Tall bowl offers seating 2" higher than Comfort Height® for enhanced comfort, ease of sitting and standing, and gracious accessibility.
- Combines with a K-4467 tank to create a complete K-25224 toilet.

Installation

- Standard 12" (305 mm) rough-in.
- Three-bolt quick-connect installation.
- Seat not included.

Recommended Products/Accessories

K-23726 Drain treatment
K-23724 Toilet cleaner & disinfectant
K-23734 Toilet bowl cleaner & disinfectant



Codes/Standards



ASME A112.19.2/CSA B45.1

KOHLER® Toilets and Seats Limited Warranty

See website for detailed warranty information.

Available Colors/Finishes

Color tiles intended for reference only.

| Color | Code | Description |
|--|------|--------------|
|  | 0 | White |
|  | 96 | Biscuit |
|  | 7 | Black Black™ |

No image available.
This product is a component and not intended to be a standalone installation.

Technical Information

All product dimensions are nominal.

| | |
|---------------|------------------------|
| Toilet type: | Two-piece, Floor-mount |
| Waste Outlet: | Floor |
| Bowl shape: | Elongated |
| Flush type: | Class Five® |
| Rough-in: | 12" (305 mm) |

Notes

Install this product according to the installation instructions.

Features

- Hybrid heater provides continuously heated water for consistent comfort.
- Heated seat with five temperature settings.
- Stainless steel wand with automatic UV-light self-sanitization.
- LED lighting illuminates the bowl to serve as a night-light.
- Sleek, handheld remote control with two programmable user presets.
- Front and Rear Wash modes provide warm water for cleansing.
- Adjustable water temperature and water pressure.
- Choose oscillating or pulsating spray.
- Warm-air drying system with adjustable air speed and temperature.
- Automatic deodorization with carbon filter for odor control.
- Quiet-Close™ lid closes slowly and quietly without slamming.
- Quick-Release™ hinges allow seat to be unlatched from toilet for easy removal and convenient cleaning; no tools required.
- Grip-Tight bumpers add stability and prevent shifting.
- Ergonomically designed for comfortable seating.

Material

- Plastic

Installation

- Requires connection to toilet water supply line. All hoses and connections are included.
- Requires Phillips screwdriver and adjustable wrench for installation.
- Dedicated electrical GFCI circuit required (120V, 15A, 60Hz, 1800W).
- Fits most elongated toilets.

Components

Additional included component/s: T-fitting, Inlet water supply hose, and Seat mounting bracket.



Codes/Standards

ASME A112.4.2/CSA B45.16
UL 1431
CSA C22.2 No. 64
CSA C22.2 No. 68

KOHLER® Intelligent Toilet and C3® Cleansing Seat Three-Year Limited Warranty

See website for detailed warranty information.

Available Color/Finishes

Color tiles intended for reference only.

| Color | Code | Description |
|-------|------|-------------|
|-------|------|-------------|

| | | |
|--|---|-------|
|  | 0 | White |
|--|---|-------|

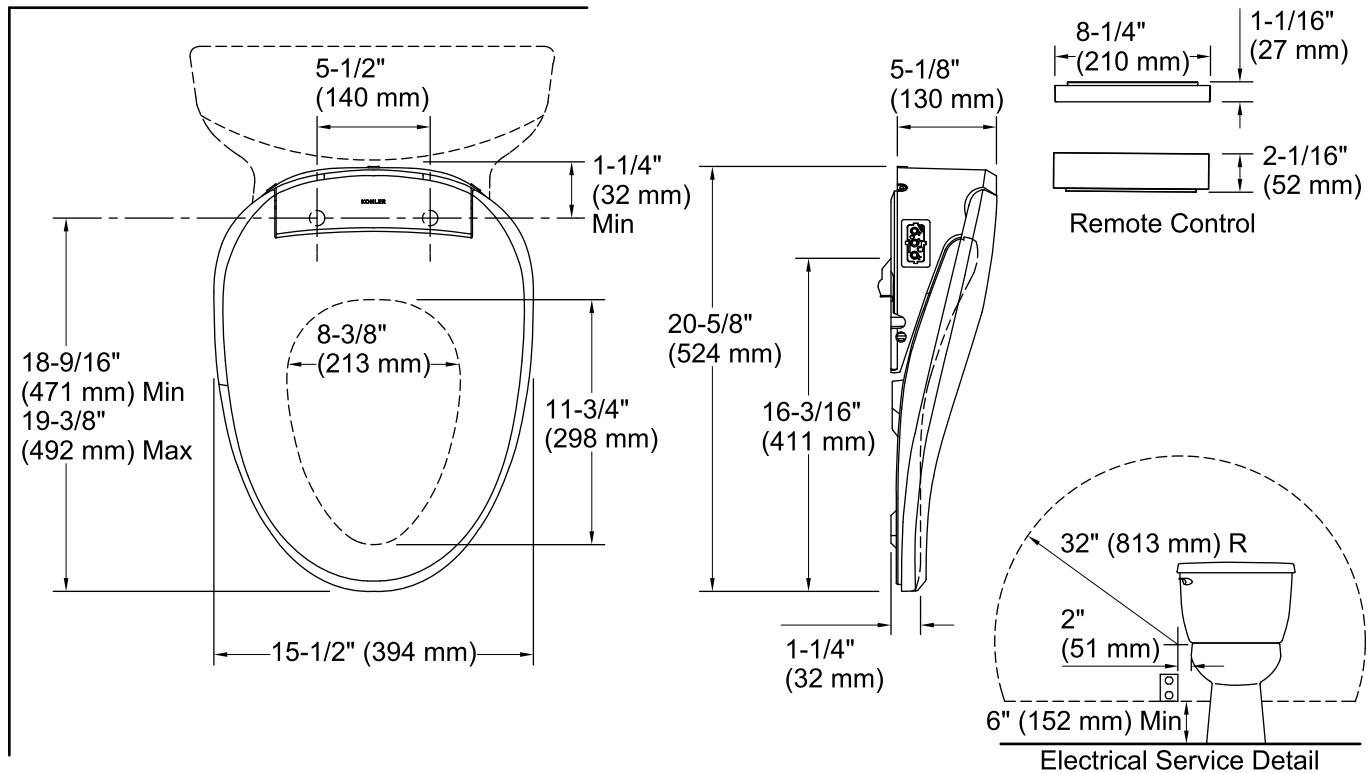

Required Electrical Service

One circuit required, protected with Class A Ground-Fault Circuit-Interrupter (GFCI) or Residual Current Device (RCD).

120 V, 15 A, 60 Hz

Technical Information

All product dimensions are nominal.

Seat shape type: Elongated
 Seat front type: Closed-front
 Seat-mounting holes: 5-1/2" (140 mm)
 Power cord length: 43" (1092 mm)

Notes

Install this product according to the installation instructions.

Connect the seat to a cold water supply of drinking quality water at a pressure of 20 psi - 80 psi (139 kPa - 551 kPa).

Do not install this seat in a location where: (1) water might be splashed on the product or (2) excessive moisture, high humidity levels, or condensation is present. This will avoid damage to the electronic components.

Do not use an extension cord with this product.

To avoid possible product malfunction, do not plug in the seat until instructed to do so.

Locate the receptacle at least 6" (152 mm) above the floor, and within a 32" (813 mm) radius measured 2" (51 mm) from the bowl ledge.