

Features

- Vitreous china
- Class Five® flushing system
- Includes left-hand polished chrome trip lever
- 1.28 gpf (4.8 lpf)
- Less supply line
- Combines with the K-4199 bowl to create a complete K-3999 Highline toilet
- Coordinates with other products in the Wellworth collection

Technology

- Single-flush gravity uses the force of gravity and a precision-engineered tank to create a strong siphon during flushing
- Canister flush valve optimizes flush performance and resists warping and deterioration
- Class Five® flushing technology offers plug- and leak-free performance, extraordinary flushing, and better rinsing power for a cleaner bowl

Water Conservation & Rebates

- WaterSense® toilets meet strict EPA flushing guidelines, including using at least 20 percent less water than 1.6-gallon toilets
- Eligible for consumer rebates in some municipalities

Optional Accessories

K-1954 Touchless Toilet Flush Kit



Codes/Standards





ASME A112.19.2/CSA B45.1

KOHLER® One-Year Limited Warranty

See website for detailed warranty information.

Available Color/Finishes

Color tiles intended for reference only.

Color	Code	Description
	0	White
	96	Biscuit
	47	Almond
	7	Black Black™

No image available.

This product is a component and not intended to be a standalone installation.

Technical Information

All product dimensions are nominal.

Toilet type: Two-piece

Notes

Install this product according to the installation instructions.



Highline® Tall

Elongated tall toilet bowl
K-22661

Features

- Elongated bowl offers added room and comfort.
- Highline® Tall bowl offers seating 2" higher than Comfort Height® for enhanced comfort, ease of sitting and standing, and gracious accessibility.
- Combines with a K-4467 tank to create a complete K-25224 toilet.

Installation

- Standard 12" (305 mm) rough-in.
- Three-bolt quick-connect installation.
- Seat not included.

Recommended Products/Accessories

K-23726 Drain treatment
K-23724 Toilet cleaner & disinfectant
K-23734 Toilet bowl cleaner & disinfectant



Codes/Standards



ASME A112.19.2/CSA B45.1

KOHLER® Toilets and Seats Limited Warranty

See website for detailed warranty information.

Available Colors/Finishes

Color tiles intended for reference only.

Color	Code	Description
	0	White
	96	Biscuit
	7	Black Black™

No image available.
This product is a component and not intended to be a standalone installation.

Technical Information

All product dimensions are nominal.

Toilet type:	Two-piece, Floor-mount
Waste Outlet:	Floor
Bowl shape:	Elongated
Flush type:	Class Five®
Rough-in:	12" (305 mm)

Notes

Install this product according to the installation instructions.

Features

- Elongated seat with Cleansing Functionality.
- Touchscreen Remote Control (includes 2 programmable user presets)
- Continuously heated water with adjustable temperature settings
- Heated seat with adjustable temperature settings
- Quick-Release™ design for ease of cleaning
- Quiet-Close™ functionality to prevent seat from slamming
- Automatic deodorization function for odor control
- Automatic nightlight function to illuminate the bowl
- Energy save function
- Anti-microbial materials used in seat and nozzle
- Air blower function allowing selection of air speed and temperature
- Single stainless steel wand with adjustable water pressure, temperature, and pulsate settings

Components

Additional included component/s: Remote, and Supply hose.



Codes/Standards

ASME A112.4.2
UL 1431
CSA C22.2 No. 64
CSA C22.2 No. 68

KOHLER Intelligent Toilet and C3 Cleansing Seat Three-Year Limited Warranty



KOHLER Intelligent Toilet and C3 Cleansing Seat Three-Year Limited Warranty

See website for detailed warranty information.

Available Color/Finishes

Color tiles intended for reference only.

Color	Code	Description
-------	------	-------------

	0	White
	96	Biscuit

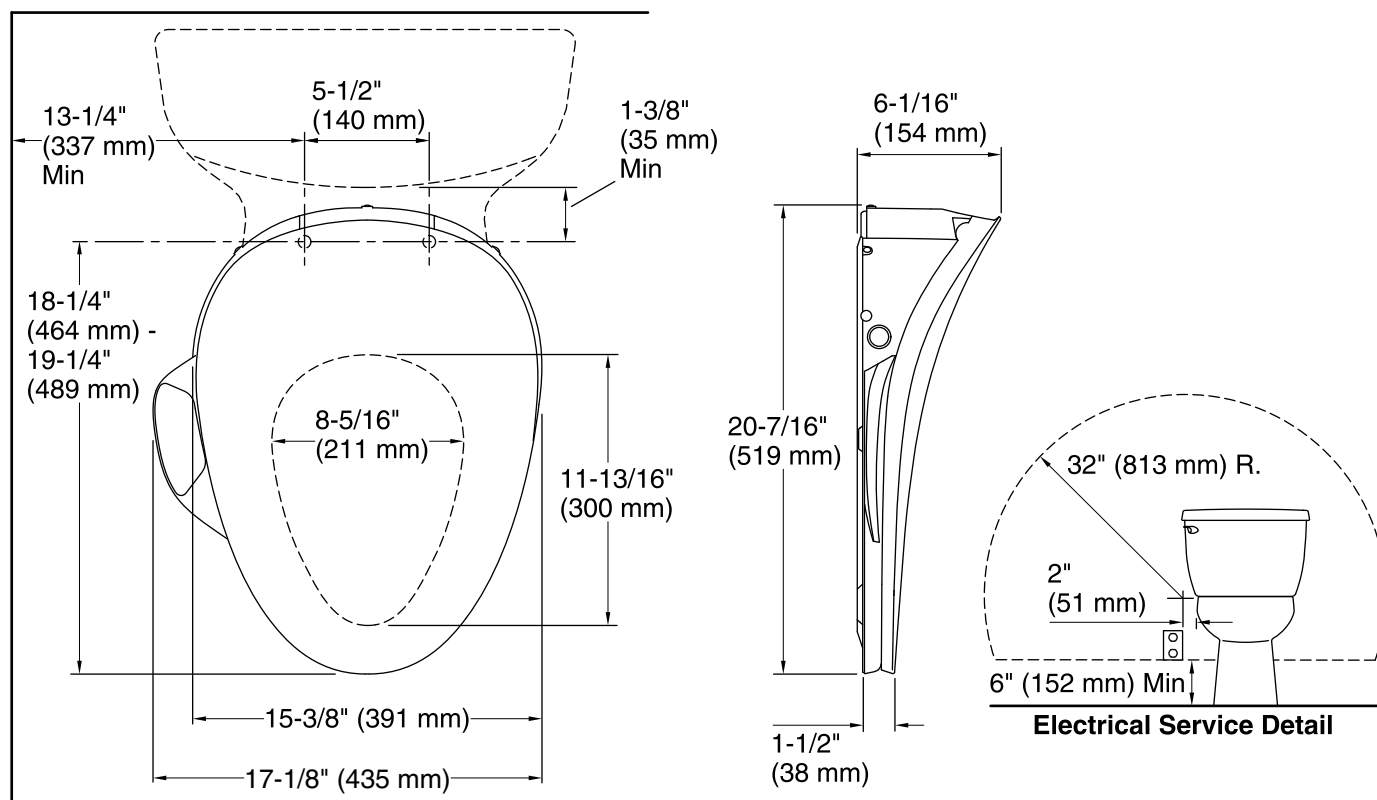

Required Electrical Service

One dedicated circuit required, protected with Class A Ground-Fault Circuit-Interrupter (GFCI) or Residual Current Device (RCD).

120 V, 15 A, 60 Hz

Technical Information

All product dimensions are nominal.

Seat shape type: Elongated
 Seat front type: Closed front
 Seat hinge type: Quiet-Close™
 Seat-mounting holes: 5-1/2" (139 mm)
 Power cord length: 46" (1168 mm)

Notes

Install this product according to the installation guide.

Connect the seat to a cold water supply of drinking quality water at a pressure of 20 psi - 80 psi (139 kPa - 551 kPa).

Do not install this seat in a location where: (1) water might be splashed on the product or (2) excessive moisture, high humidity levels, or condensation is present. This will avoid damage to the electronic components.

Do not use an extension cord with this product.

To avoid possible product malfunction, do not plug in the seat until instructed to do so.

Locate the receptacle at least 6" (152 mm) above the floor, and within a 32" (813 mm) radius measured 2" (51 mm) from the bowl ledge.