

Features

- Vitreous china
- Class Five® flushing system
- Includes left-hand polished chrome trip lever
- 1.28 gpf (4.8 lpf)
- Less supply line
- Combines with the K-4199 bowl to create a complete K-3999 Highline toilet
- Coordinates with other products in the Wellworth collection

Technology

- Single-flush gravity uses the force of gravity and a precision-engineered tank to create a strong siphon during flushing
- Canister flush valve optimizes flush performance and resists warping and deterioration
- Class Five® flushing technology offers plug- and leak-free performance, extraordinary flushing, and better rinsing power for a cleaner bowl

Water Conservation & Rebates

- WaterSense® toilets meet strict EPA flushing guidelines, including using at least 20 percent less water than 1.6-gallon toilets
- Eligible for consumer rebates in some municipalities

Optional Accessories

K-1954 Touchless Toilet Flush Kit



Codes/Standards





ASME A112.19.2/CSA B45.1

KOHLER® One-Year Limited Warranty

See website for detailed warranty information.

Available Color/Finishes

Color tiles intended for reference only.

Color	Code	Description
	0	White
	96	Biscuit
	47	Almond
	7	Black Black™

No image available.

This product is a component and not intended to be a standalone installation.

Technical Information

All product dimensions are nominal.

Toilet type: Two-piece

Notes

Install this product according to the installation instructions.



Highline® Tall

Elongated tall toilet bowl
K-22661

Features

- Elongated bowl offers added room and comfort.
- Highline® Tall bowl offers seating 2" higher than Comfort Height® for enhanced comfort, ease of sitting and standing, and gracious accessibility.
- Combines with a K-4467 tank to create a complete K-25224 toilet.

Installation

- Standard 12" (305 mm) rough-in.
- Three-bolt quick-connect installation.
- Seat not included.

Recommended Products/Accessories

- K-23726 Drain treatment
- K-23724 Toilet cleaner & disinfectant
- K-23734 Toilet bowl cleaner & disinfectant



Codes/Standards



ASME A112.19.2/CSA B45.1

KOHLER® Toilets and Seats Limited Warranty

See website for detailed warranty information.

Available Colors/Finishes

Color tiles intended for reference only.

Color	Code	Description
	0	White
	96	Biscuit
	7	Black Black™

No image available.

This product is a component and not intended to be a standalone installation.

Technical Information

All product dimensions are nominal.

Toilet type:	Two-piece, Floor-mount
Waste Outlet:	Floor
Bowl shape:	Elongated
Flush type:	Class Five®
Rough-in:	12" (305 mm)

Notes

Install this product according to the installation instructions.

Features

- Hybrid heater provides continuously heated water for consistent comfort.
- Stainless steel wand with automatic UV-light self-sanitization.
- Sleek, handheld remote control with two programmable user presets.
- LED lighting illuminates the bowl to serve as a nightlight.
- Heated seat with five temperature settings.
- Front and rear wash modes provide warm water for cleansing.
- Adjustable water temperature and water pressure.
- Quiet-Close™ lid closes slowly and quietly without slamming.
- Quick-Release™ hinges allow seat to be unlatched from toilet for easy removal and convenient cleaning; no tools required.
- Toilet seats are not returnable to Kohler Co. if opened or outside of original packaging.

Material

- Plastic.

Installation

- Requires connection to toilet water supply line. All hoses and connections are included.

Recommended Products/Accessories

K-3814 Skirted Trapway Two-Piece Toilet
K-3814-RA Skirted Trapway Two-Piece Toilet
K-5172 Comfort Height® Toilet
K-5172-RA Comfort Height® Toilet
K-3551 Comfort Height® Toilet
K-3619 Comfort Height® Toilet
K-3619-RA Comfort Height® Toilet

Included Components

Additional Components:
Inlet water supply hose
Seat mounting bracket
T-fitting



Codes/Standards

ASME A112.4.2/CSA B45.16
UL 1431
CSA C22.2 No. 64
CSA C22.2 No. 68

KOHLER® Intelligent Toilet and C3® Cleansing Seat Three-Year Limited Warranty

See website for detailed warranty information.

Available Colors/Finishes

Color tiles intended for reference only.

Color	Code	Description
-------	------	-------------

	0	White
--	---	-------

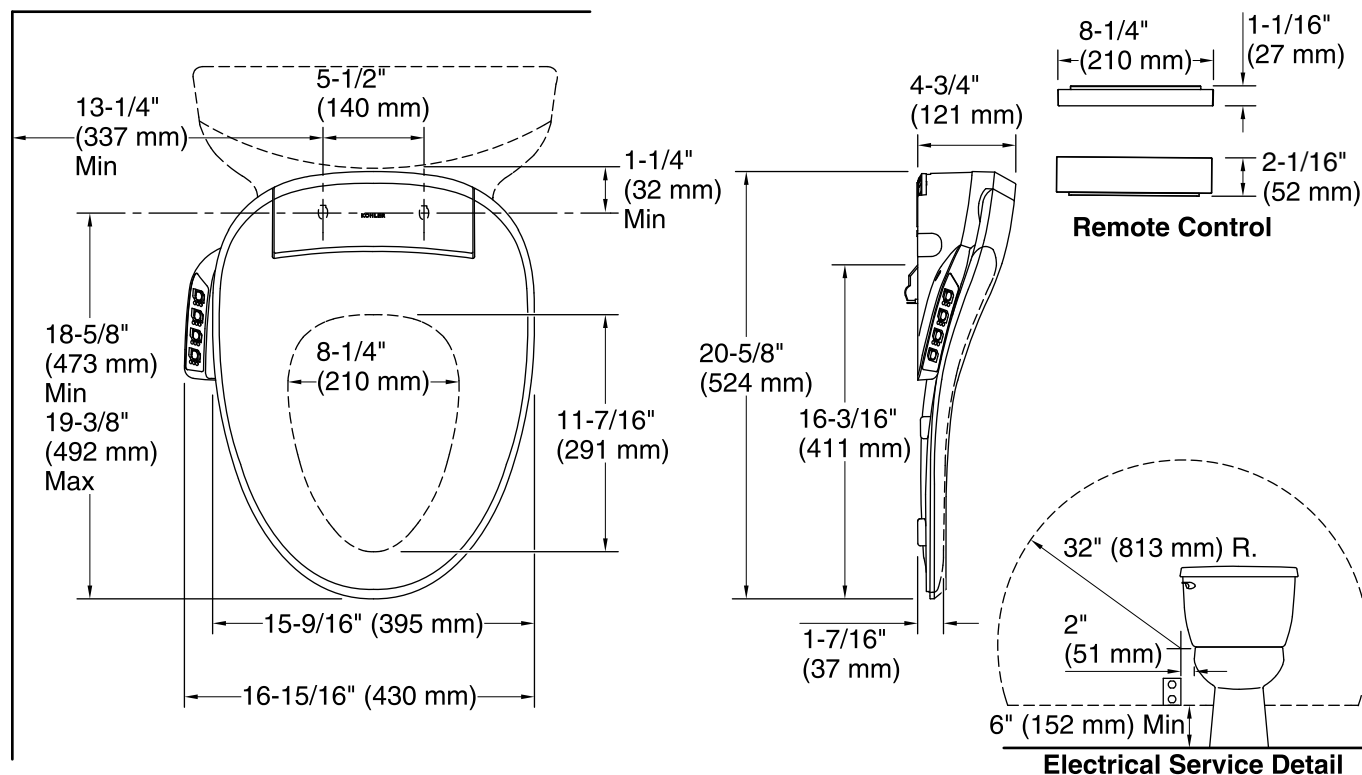

Required Electrical Service

One dedicated circuit required, protected with Class A Ground-Fault Circuit-Interrupter (GFCI). Outside North America, this device may be known as a Residual Current Device (RCD).
 120 V, 15 A, 60 Hz

Technical Information

All product dimensions are nominal.

Seat shape type: Elongated
 Seat front type: Closed-front
 Seat-mounting holes: 5-1/2" (140 mm)
 Power cord length: 43" (1092 mm)

Notes

- Install this product according to the installation instructions.
- Connect the seat to a cold water supply of drinking quality water at a pressure of 20 psi - 80 psi (139 kPa - 551 kPa).
- Do not install this seat in a location where: (1) water might be splashed on the product or (2) excessive moisture, high humidity levels, or condensation is present. This will avoid damage to the electronic components.
- Do not use an extension cord with this product.
- To avoid possible product malfunction, do not plug in the seat until instructed to do so.
- Locate the receptacle at least 6" (152 mm) above the floor, and within a 32" (813 mm) radius measured 2" (51 mm) from the bowl ledge.