



Premium XL 25" x 26" rectangular two-door medicine cabinet
Embark™
cabinet
K-56003

Features

- 4" (102 mm) -deep shelves offer more room for larger jars, bottles, and grooming supplies
- Two adjustable tempered-glass shelves offer additional bathroom storage
- Two full-overlay mirrored doors with flat edges
- Mirrored interior
- Three-way adjustable slow-close hinges with 105° opening capability for easy cabinet access
- Easy-hang bracket mounts cabinet securely and simplifies surface-mount applications
- Includes side mirror kit for surface-mount installation



Material

- Anodized aluminum construction with a durable rustproof and chip-resistant finish

Codes/Standards

None Applicable

Installation

- Surface-mount or recessed
- Can be installed with left- or right-hand swing
- Includes mounting hardware for surface or recessed installation

KOHLER® One-Year Limited Warranty

See website for detailed warranty information.

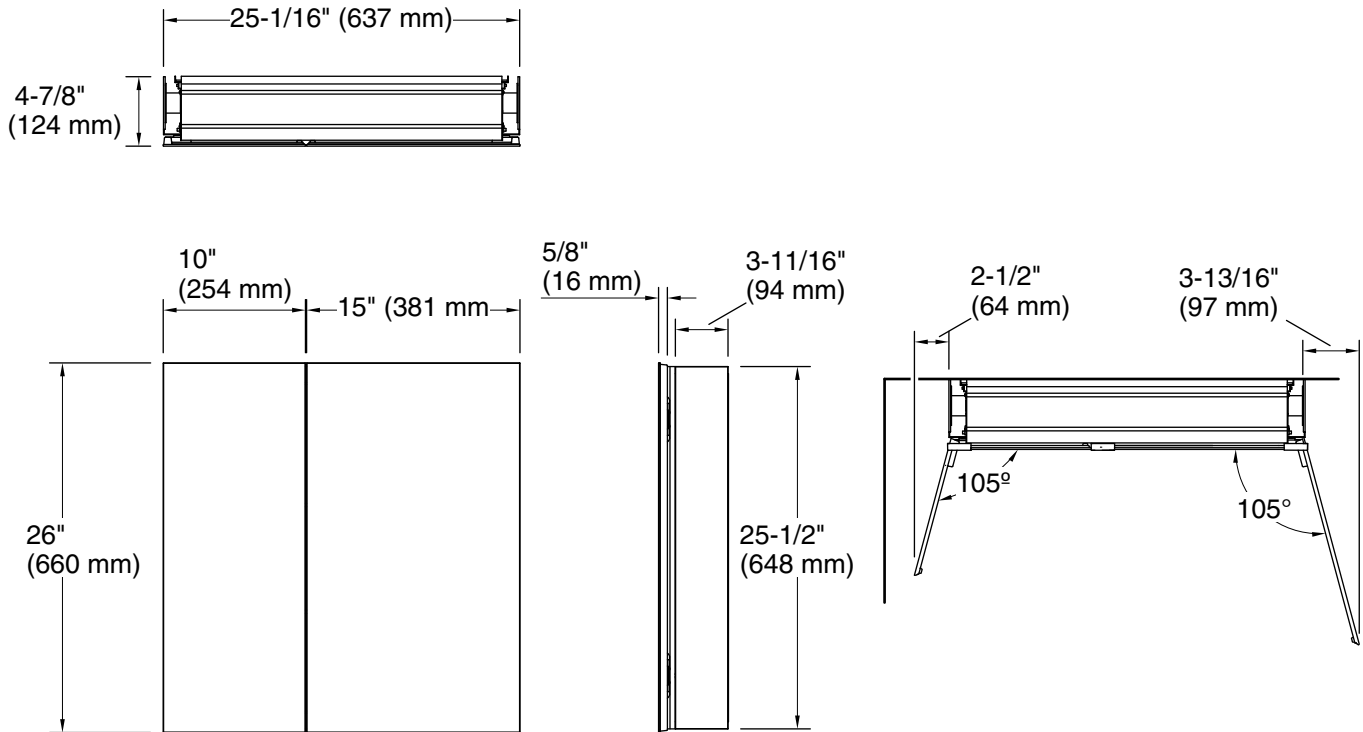

Technical Information

All product dimensions are nominal.

Notes

Install this product according to the installation guide.